

# DEVELOPMENT OF A 46 STOREY APARTMENT BUILDING IN RAJAGIRIYA

GROUP 2

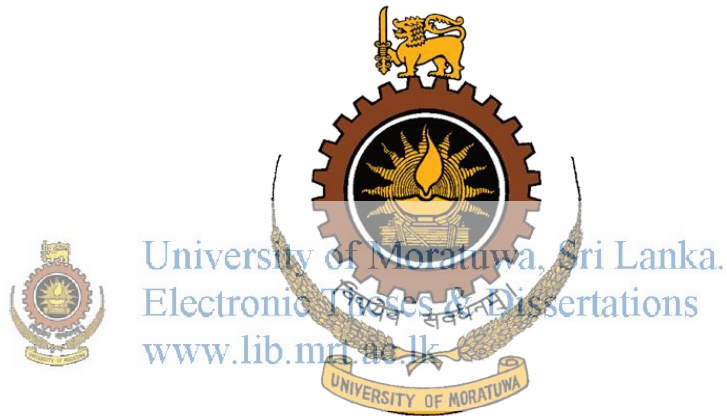

Department of Civil Engineering

University of Moratuwa

Moratuwa

Sri Lanka

## PREFACE

Colombo city is the business capital in Sri Lanka. The growth of businesses in the city is increasing day by day. As a result of this situation, many urban dwellers those living outside the capital are attracted to the city. The traffic conditions, environmental pollution around Colombo district is getting higher due to these unavoidable movements of vehicles, etc. Solutions for the situation are being implemented as part of the master plan for development of the city. Most of the suburban population who travel to Colombo daily cannot afford to build their own houses within city limits as the cost of land and cost of construction are not within their means. Purchasing an apartment on payment in instalments is an ideal alternative especially to private sector executives who travel to Colombo daily with their whole family as most such children attend prestigious schools in Colombo. The Sky Residencies high-rise building project was planned to cater to this sector of population with availability of state of the art apartments priced reasonably leading to improvement of quality of life.

The Sky Residencies will be located in Buthgamuwa road Rajagiriya very close to the city of Colombo. The land area is approximately 180 perches. Sky Residencies is planned for a height of 165m and consist of 46 stories including 5 parking floors, 40 apartment floors and a recreational floor. This is designed to facilitate 160 apartments with the choice of 2 bedroom and 3 bedroom apartment. Sky Residencies is designed according to the green concept to achieve sustainable development. It will become one of the most sustainable buildings in Sri Lanka and will be unique in its architecture and structural features. Facilitation of obtaining a soft loan from a reputed bank to the purchaser is planned to attract buyers.

According to the Sri Lanka real estate market brief, KPMG condominium property developments are having average pre construction sale ratio of around 50% while high more prestige development like empire emperor lumiere and trillium tend to have about 80% preconstruction sale ratio. Therefore there is a huge condominium market in Colombo. Sky residencies will be at the top of the market when it's initiated because of its unique features.

There are eleven Chapters in this report. This final report is prepared to give the reader a detail and complete intuition to the Project. Project. Vision, mission, objectives and goals of the project were described here. Feasibility study, Competitive advantage of this project and detail design of this project is described in this report.

Social, financial and technical feasibility studies were also considered. Since some environmental issues can arise due to this project, it is very important to do an Initial Environment Examination (IEE). On the other hand a Traffic Impact Assessment (TIA) is needed in order to visualize the traffic impact to the surrounding area due to this project. Therefore a detailed IEE and a detailed TIA were included in this report.. The architectural design was done to accommodate topographical variations. The services arrangement for lift, supply water, waste treatment methods are included in this project. The computer analysis for the building was done by using SAP 2000 software. Different load cases dead, imposed and dynamic loads such as wind were also considered. As stipulate in government requirement for new buildings in Sri Lanka safety against earthquakes is also designed. In addition to that thermal comfort was assessed by using DEROB LTH .Main Items of the BOQ are included together with the Details. At the end of the report further detail & architectural drawings were given in the annex. All the design parts were done in accordance with a code of practice and guidelines. This report will give a detail description about the project objectives, challenges we faced and how we overcome them to the reader.

**TEAM MEMBERS**

Bogahawatta J.R.M	100061L
Danushka K.K.G.K	100074E
De Silva M.P.I.M	100084J
De Silva T.D.D.p	100086R
Dadigamuwa. K.V	100089E
Denagama T.D	100091D
Dewasumithra M.S.D	100095T
Dissanayake B.S	100105D
Dissanayake D.M.K.W	100106G
Edirisooriya U.J.W	100113B
Epasinghe M.R	100120T

Contribution: The main 11 tasks given in the TOR were assigned to each member to act as the leader for the task. All 11 team members contributed to the leader of the main topic in the design process. The equal dedication of all team members are the pillars of success of this project.



University of Moratuwa, Sri Lanka.  
Electronic Theses & Dissertations  
[www.lib.mrt.ac.lk](http://www.lib.mrt.ac.lk)

## ACKNOWLEDGEMENT

It is our pleasure to thank all personnel, organizations and authorities who gave us a chance to do Comprehensive Design Project (CDP) and to those who made it fruitful and success. CDP has been one of the best learning experiences in our undergraduate life.

We owe a debt of gratitude to the supervisors of our group **Senior Prof. M. T. R. Jayasinghe** and **Prof. (Mrs) C. Jayasinghe** Department of Civil Engineering, University of Moratuwa for valuable advice and guidance provided even when they are on such a busy schedule. They were available to assist us anytime we were having troubles with the project. Their guidance was the best motivation for us to work tirelessly day and night to make this a success. One word of their encouragement and appreciation meant so much to us.

Moreover we would like to express our gratitude to all the lecturers of department of civil engineering, University of Moratuwa for teaching us subjects in the last 4 years which helped us in all facets of designs in this project. The lecturers of all divisions helped us when we needed keenly.

We would like to appreciate the support given by **Mr. Senaka** – Design office Manager (Projects) at Maga Engineering Pvt Ltd and Mr. Pradeep- Project Manager (Sky Gurden) at Maga Engineering pvt Ltd for providing us the opportunity to visit the Clear Point construction site and other sites.

We would like to give our warmest thanks to our colleagues for their support to make the Comprehensive Design Project a success.



University of Moratuwa, Sri Lanka.

Electronic Theses & Dissertations

[www.lib.mrt.ac.lk](http://www.lib.mrt.ac.lk)

Group-02,  
Comprehensive Design Project,  
Department of Civil Engineering,  
University of Moratuwa,  
Moratuwa,  
Sri Lanka.

# CONTENTS

Preface.....	i
ACKNOWLEDGEMENT .....	iii
List of Tables.....	xi
List of Figures .....	xii
1. introduction to the project .....	1
1.1. Introduction .....	1
1.2. Clients requirements .....	1
1.3. Project Details.....	2
1.4. Methodology.....	3
2. Feasibility study .....	5
2.1. Building function selection.....	5
2.1.1. Zoning regulations.....	5
2.1.2. Social feasibility.....	6
2.1.3. Environmental feasibility .....	6
2.1.4. Technical feasibility .....	6
2.1.5. Market Feasibility .....	7
.....	8
2.2. Selection of Building Form .....	8
2.3. Building height selection .....	11
2.4. Feasibility of Facilities .....	12
2.5. Financial feasibility of proposed development.....	12
3. Initial Environmental Examination .....	16
3.1. Selecting EIA or IEE .....	16
3.2. Terms of Reference for the IEE: Attached to annex .....	17
3.3. INITIAL ENVIRONMENTAL EXAMINATION REPORT .....	17
Executive Summary .....	17

4.	Traffic Impact assesement.....	44
5.	Architectural concept .....	57
5.1.	Building Architecture .....	57
5.1.1.	Shape and Orientation of the Building.....	57
5.2.	Planning of Activity Space of the Building.....	58
5.2.1.	Parking Area.....	58
5.2.2.	Recreational Area.....	59
5.2.3.	Apartments .....	60
5.3.	Landscaping.....	64
5.3.1.	Landscape Design Requirements .....	64
5.3.2.	Main features suggested in landscape design.....	64
6.	DESIGN OF SERVICES .....	66
6.1.	DESIGN OF LIFT ARRANGEMENT .....	66
6.1.1.	Introduction.....	66
6.1.2.	Calculating the passenger lift requirem.....	66
6.2.	ARRANGEMENT OF THE STAIR CASE.....	67
6.2.1.	Introduction .....	67
6.2.2.	Calculating the dimension of the stair case.....	67
6.3.	WATER SUPPLY SYSTEM .....	68
6.3.1.	Introduction .....	68
6.3.2.	Storage requirement .....	68
6.3.3.	Pipeline design .....	68
6.4.	ABOVE GROUND WASTE WATER DISPOSAL SYSTEM .....	71
6.4.1.	Design the Size of the Soil (Black Water) Pipe .....	71
6.4.2.	Design of Pipes for Grey Water .....	71
6.5.	BELOW GROUND WASTE DISPOSAL SYSTEM .....	73
6.5.1.	Assumptions .....	73

6.5.2.	Soil Drainage.....	73
6.5.3.	Waste water drainage .....	73
6.6.	SOLID WASTE MANAGEMENT.....	75
6.6.1.	Design of the chute for the high rise building.....	75
6.7.	FIRE FIGHTING SYSTEM.....	78
6.7.1.	Proposed Fire Fighting Systems.....	78
6.7.2.	Fire Detection Systems.....	81
6.7.3.	Emergency Evacuation for People with Disabilities.....	81
6.8.	Air Conditioning.....	82
6.9.	ELECTRICAL SUPPLY .....	82
6.9.1.	Lighting design.....	82
	We have to establish substation for that building to provide that amount of electrical demand. We use 2 MW transformers for substation.....	85
6.9.2.	Substation.....	85
6.9.1.	Consumer Unit.....	86
6.9.2.	Rising main electricity distribution.....	86
6.10.	Building Services integration.....	87
6.11.	Thermal Performance Assessment.....	88
6.11.1.	INTRODUCTION .....	88
6.11.2.	PROCEDURE .....	88
6.12.	MEASURES TAKEN TO INCREASE THE THERMAL COMFORT .....	94
7.	ANALYSIS OF STRUCTURE USING SAP2000 .....	97
7.1.	Introduction .....	97
7.2.	Methodology.....	97
7.3.	Preparation of general arrangement.....	97
7.3.1.	Selection of element sizes .....	99
7.1.	Identification of proper materials and their properties .....	100

7.2.	Identification of loading arrangement for the building .....	101
7.2.1.	Dead loads .....	101
7.2.2.	Imposed load .....	101
7.2.3.	Wind load .....	102
7.3.2.	Springs.....	104
7.3.3.	Seismic load .....	104
7.3.	Dynamic behavior of the building .....	105
7.4.	Outputs and Validation of the Model .....	105
7.4.1.	Axial forces .....	106
7.4.2.	Sub structure.....	106
7.3.4.	Other results .....	107
7.5.	Lateral stability of the structure.....	108
7.5.1.	Cross wind response.....	108
7.5.2.	Along wind response.....	108
7.6.	Drift calculation.....	108
8.	Design of the superstructure.....	110
8.1.	Introduction to structural system .....	110
8.1.1.	Conceptual Design Phase .....	110
8.1.2.	Load transfer mechanism .....	111
8.1.3.	Structural arrangement .....	111
8.1.4.	Effect of Relative Strength of Beams and Columns .....	111
8.2.	Preliminary Design .....	111
8.2.1.	Introduction .....	111
8.2.2.	Criteria used for member size selection .....	112
8.3.	Detail Design .....	113
8.3.1.	Slab design .....	113
8.3.2.	Stair Case Design .....	116



8.3.3.	Beam Design .....	116
8.3.4.	Column Design.....	116
8.3.5.	Shear Wall Design.....	116
8.3.6.	Coupling Beam Design .....	117
8.3.7.	Swimming pool Design.....	118
8.3.8.	Water sump Design .....	119
8.4.	Disaster Resistive Design .....	120
8.4.1.	Fire Resistance .....	120
8.4.2.	Earthquake Resistance.....	121
8.4.3.	Structural Form .....	121
8.4.4.	Effects of Eccentric Cores.....	122
8.4.5.	Effect of Soft Zoning.....	122
8.4.6.	Effect of Relative Strength of Beams and Columns .....	122
8.4.7.	Member Sizing.....	122
8.4.8.	Analysis.....	122
8.4.9.	Detailing .....	123
8.4.10.	Structural detailing with disaster resistant detailing.....	123
9.	Substructure Design .....	125
9.1.	Literature Survey .....	125
9.2.	Site Visit .....	125
9.3.	Subsurface Investigation.....	125
9.4.	Estimation of soil strength parameters .....	127
9.4.1.	Specimen Calculation-Energy Approach Method (Borehole location1) .....	128
9.4.2.	Settlement of the piles .....	130
9.4.3.	The rationale behind selection of bored piles over other types of piles and foundations 132	
9.4.4.	Construction difficulties and suitable remedial measures.....	132

9.4.5.	Estimation of Skin frictional resistance and end bearing capacities .....	133
9.4.6.	Reinforcements for 1 m diameter piles .....	136
9.4.7.	Pile Raft Design .....	137
9.5.	Earth Retaining Structure for excavation .....	142
9.6.	Procedure .....	143
9.6.1.	General Details .....	144
10.	Sustainable concepts adopted.....	149
10.1.	LEED Certification for the building .....	149
10.2.	Location, Linkages and Sustainable Site Planning .....	149
10.2.1.	Site Selection (Max. points: 2) .....	150
10.2.2.	Surface Water Management (Max. Points: 6) .....	150
10.2.3.	Soil Conservation (Max. Points: 2) .....	150
10.2.4.	Development of density and Community Connectivity (Max. Points: 3) .....	152
10.2.5.	Alternative transport (Max. Points: 6+1) .....	152
10.2.6.	Landscaping and Protecting of Habitat (Max. Points: 1) .....	153
10.2.7.	Sanitary and Safety Facilities .....	154
10.2.8.	Pollution Mitigation.....	154
10.2.9.	Water Efficiency .....	155
10.2.10.	Water Reuse (Max. points: 5).....	155
10.2.11.	Rainwater Harvesting System .....	155
10.2.12.	Waste water treatment plant .....	156
<b>10.2.13.</b>	<b>Irrigation System (Max. Points: 4).....</b>	<b>161</b>
10.2.14.	Indoor Water Use (Max. Points: 6) .....	163
10.3.	Energy and Atmosphere.....	166
10.3.1.	Insulation, Air Infiltration and Windows (max. points: 2+3+3) .....	166
10.3.2.	Lighting (max. points: 3) .....	168
10.3.3.	Renewable Energy (max. points: 10) .....	171

10.4.	Materials and Resources .....	173
10.4.1.	Reduction in waste during construction (max. 3 points).....	173
10.4.2.	Material Reuse (max. 3 points).....	173
10.4.3.	Materials Selection with Less Embodied Energy (Max. Points: 8).....	174
10.4.4.	Indoor Environmental Quality.....	174
10.4.5.	Low-Emitting Materials—Adhesives and Sealants (1 point).....	174
10.4.6.	Low Emitting Materials – Paints and Coatings (1 point).....	175
10.4.7.	Low Emitting Materials—flooring Systems (1 point).....	175
10.4.8.	Furnishings and Equipment. ....	175
10.4.9.	Vehicle Emission Protection (Max. Points: 3) .....	175
10.5.	Innovation and Design .....	176
10.6.	Awareness and Education .....	176
11.	Bill of Quantity.....	178
11.1.	Introduction.....	178
11.2.	Grand Summary of BOQ.....	178
11.3.	Detailed Bill of Quantity.....	179

## APPENDICES

## LIST OF TABLES

Table 1.1 Project Details .....	2
Table 2.1 Comparing Alternatives .....	10
Table 2.2 Details on existing tallest buildings in Colombo .....	11
Table 2.3 Details on proposed tallest buildings in Colombo .....	11
Table 2.4 Estimated Cost for Financial Feasibility .....	13
Table 2.5 NPV IRR Calculation.....	14
Table 5.1 Features and space allocation within the apartment.....	63
Table 5.2 Features and space allocation within the apartment.....	63
Table 6.6.1 Selected pipe diameters for a typical 3 bed room apartment .....	69
Table 6.6.2 Selected pipe diameters for vertical pipes on top 5 floors .....	69
Table 6.6.3 Typical pipe sizes for 2 bed room apartment .....	69
Table 6.4 Calculation of discharge units per floor of one pipe .....	71
Table 6.5 Type of Extinguisher.....	79
Table 6.6 Air conditioning loading requirement.....	82
Table 6.7 12w Par 38 Led Light Bulb .....	82
Table 6.8 Summary of the lighting fittings .....	83
Table 6.9 Summary of the Socket Outlet .....	84
Table 6.10 Properties of light colour and dark colour.....	89
Table 6.11 Color type.....	89
Table 6.12 Indoor temperature variation in °C (CSEB light colour)walls).....	92
Table 6.13 Temperature variation of vol_1 with different wall material .....	93
Table 7.1 - Typical dimensions of members.....	100
Table 7.2 - Material properties .....	101
Table 7.3 - Wall loads .....	101
Table 7.4 - Wind loads for each 5 floor levels .....	102
Table 7.5 - Wind loads on nodes in x direction .....	103
Table 7.6 - Wind loads on nodes in y direction .....	103
Table 7.7 - Spring values for piles .....	104
Table 7.8 - Seismic load distribution in each floor - static analysis.....	105
Table 7.9 - Fundamental period in three aspects.....	105
Table 8.1: Span/effective depth ratios for initial design of beams.....	112
Table 8.2: Span/effective depth ratios for initial design of slabs .....	112
Table 8.3: Provided reinforcement for each slab panel.....	115
Table 8.4: Fire resistance of structural members .....	121
Table 9.1 Selection of soil parameters for design .....	129
Table 9.2 Assumed E and v values .....	130
Table 9.3 Pile Capacities .....	136
Table 10-1: Selected Plants for the Building .....	154
Table 10-2: : Runoff coefficients, Source: Sri Lanka Green Building Council.....	155
Table 10-4: Tolerance limits for discharge of effluents into public sewers with central treatment plants - <i>National Environmental Act, No. 47 OF 1980 - list vii</i> .....	158
Table 10-7: Comparisson of the water requirement with duel fush and single flush toilets.....	165
Table 10-8: Properties of different double glazing windows.....	167
Table 10-9: A comparisson of the lifetime cost of different types of bulbs.....	170
Table 10-10: System Performance .....	172
Table 10-12: Embodied Energy comparisson of the possible materials .....	174

## LIST OF FIGURES

Figure 1.1 Location of the Site.....	4
Figure 1.2 View of the building .....	4
Figure 2.1 Zoning Regulations.....	5
Figure 2.2 Selection of function.....	8
Figure 2.3 Alternative 1 .....	8
Figure 2.4 Alternative 2 .....	9
Figure 2.5 Alternative 3 .....	9
Figure 3.1 Site Location .....	22
Figure 3.2 Location of site in Kaduwela Division .....	23
Figure 3.3 Site Layout.....	23
Figure 3.4 Existing Environment .....	29
Figure 3.5 Figure 3.7 Existing Environment.....	29
Figure 3.6 Existing Environment .....	30
Figure 5.1 Shape of the Building .....	57
Figure 5.2 Plan view of the typical parking floor .....	58
Figure 5.3 Plan view of the typical parking floor .....	59
Figure 5.4 Recreational Area .....	59
Figure 5.5 Plan view of recreational floor.....	60
Figure 5.6 Typical apartment floor layout .....	60
Figure 5.7 Aptmnt Type 1 .....	62
Figure 5.8 Aptmnt Type 2.....	62
Figure 5.9 Landscape 1.....	64
Figure 5.10 Landscape 2.....	64
Figure 5.11 Landscape 3.....	65
Figure 5.12 Landscape 4 .....	65
Figure 6.1 Stair Case .....	68
Figure 6.2 Top of the refuse chute .....	76
Figure 6.3 Overall Design of Chute .....	77
Figure 6.4 The Extinguisher Label.....	79
Figure 6.5 Layout of the substation.....	85
Figure 6-6 The rising main system with fire prevention.....	86
Figure 6.6 Service Duct Layout .....	87
Figure 6.7 DEROB model without roof slab.....	90
Figure 6.8 DEROB model with roof slab.....	90
Figure 6.9 DEROB model with roof slab and shadings.....	91
Figure 6.10 Indoor Temperature Variation .....	92
Figure 6.11 Comparison of materials.....	94
Figure 6.12 Shading arrangement .....	96
Figure 7.1 - General arrangement in car park floors .....	98
Figure 7.2 - General arrangement in apartment floors .....	98
Figure 7.3 Idealized model.....	99
Figure 7.4 - Application of unit loads in apartment floors.....	102
Figure 7.5 - bending moment in pile caps .....	107
Figure 7.6 - Axial force on walls.....	107
Figure 7.7 - Bending moment diagrams of an apartment floor .....	108
Figure 8.1: Apartment floor slab panels.....	113
Figure 8.2: Selected slab panels in car park for design .....	115

Figure 8.3: Considered locations for provide reinforcement .....	115
Figure 8.4: Coupling beam.....	117
Figure 8.5: Section view of swimming pool .....	118
Figure 8.6: Long wall vertical reinforcement.....	118
Figure 8.7: Short wall vertical reinforcement .....	119
Figure 8.8: Dimensions of long wall in water sump .....	119
Figure 9.1 Actual Subsurface profile .....	126
Figure 9.2 Idealized sub surface profile .....	127
Figure 9.3 Skin Friction Variation .....	134
Figure 9.4 Pile Layout.....	135
Figure 9.5 Pile Reinforcement .....	137
Figure 9.6 Pile Raft .....	138
Figure 9.7 Section view of the excavation .....	144
Figure 9.8 Geometry model of the window .....	144
Figure 9.9 Initial Water table level.....	145
Figure 9.10 Installing Retaining wall and applying load due to existing buildings.....	145
Figure 9.11 Excavating up to 0.5 m from the ground level .....	146
Figure 9.12 Total Excavation .....	146
Figure 9.13 Vertical Displacement.....	147
Figure 9.14 Methods to reduce the deformations in soil retaining structures .....	148
Figure 10-3: Well protected stock pile .....	151
Figure 10-4: Geotextiles and their applications .....	151
Figure 10-5: Protected Drains .....	151
Figure 10-6: An Electric Car Re-charging Station.....	153
Figure 10-7: Proposed Unit Processes .....	158
Figure 10-8: Up flow Anaerobic Sludge Blanket (UASB) Reactor .....	160
Figure 10-9: Pressure filters .....	161
Figure 10-10: Gardens on Balconies .....	162
Figure 10-11: Drip Irrigation Systems for the balconies (top) and for green wall (bottom).....	163
Figure 10-12: Pressure assist technology and water less urinals .....	164
Figure 10-13: A Tap with Automatic Sensors .....	165
Figure 10-14: Aerating shower heads .....	165
Figure 10-15: A CSEB block (left) and a building constructed with them (right).....	167
Figure 10-16: Double glazing windows .....	168
Figure 10-17: The visual comparison above shows how well LED lights compare with other light sources.....	169
Figure 10-18: Efficient Exterior Lighting .....	170
Figure 10-19: Schematic overview of a Grid Connected Solar PV power system .....	171

# 1. INTRODUCTION TO THE PROJECT

## 1.1. Introduction

Colombo city is the business capital in Sri Lanka. The growth of businesses in the city is increasing day by day. As a result of this situation, many urban dwellers those living outside the capital are attracted to the city. The traffic conditions, environmental pollution around Colombo district is getting higher due to these unavoidable movements of vehicles, etc. Solutions for the situation are being implemented as part of the master plan for development of the city. Most of the suburban population who travel to Colombo daily cannot afford to build their own houses as the cost of land and cost of construction are not within their means. Purchasing an apartment on payment in instalments is an ideal alternative especially to private sector executives who travel to Colombo daily with their whole family as most such children attend prestigious schools in Colombo. The Sky Residencies high-rise building project was planned to cater to this sector of population with availability of state of the art apartments priced reasonably leading to improvement of quality of life.

The Sky Residencies will be located in Buthgamuwa road Rajagiriya very close to the city of Colombo. The land area is approximately 180 perches. Sky Residencies is planned for a height of 165m and consist of 46 stories including 5 parking floors, 40 apartment floors and a recreational floor. This is designed to facilitate 160 apartments with the choice of 3 bedrooms and 3 bedroom apartment. Sky Residencies is designed according to the green concept to achieve sustainable development. It will be the world tallest vertical garden and will be start of environmental revolution in Sri Lanka. Facilitation of obtaining a soft loan from a reputed bank to the purchaser is planned to attract buyers.

According to the Sri Lanka real estate market brief, KPMG condominium property developments are having average pre construction sale ratio of around 50% while high more prestige development like empire emperor lumiere and trillium tend to have about 80% preconstruction sale ratio

## 1.2. Clients requirements

A high-rise building has to construct within the given land having any function and the total project cost has to be limited below Rs.5billion. Internal rate of return has to be equal or more than 10% and the project should have a unit rate contract. The project must finish within the given period, otherwise the penalty has to be beared by the contractor.

### 1.3. Project Details

**Table 1.1 Project Details**

Project name	Sky Residencies
Location	<b>Buthgamuwa Road Rajagiriya Sri Lanka</b>
Client	<b>Indocean Developers</b>
Contractor	<b>MAGA Engineering</b>
Consultant	<b>Green Consultants</b>
Type of Contract	<b>Measure and Pay, Unit Rate Contract</b>
Building Function	<b>Residential Apartment building</b>
Land Area	<b>4500m<sup>2</sup></b>
Height of the building	<b>165m</b>
Foundation Type	<b>Cast in-situ Pile foundation</b>
Project commencement	<b>2015 August</b>
Project completion	<b>2018</b>
Project duration	<b>3 years</b>
Total cost	<b>Rs.4 billion</b>



University of Moratuwa, Sri Lanka.  
Electronic Theses & Dissertations  
www.lib.mrt.ac.lk



## 1.4. Methodology

At the outset of the project, it was discussed about the alternative functions that can be used for this location such as hotel, apartment, hotel and apartment, etc and the optimum and more feasible solution was figured out as apartments only.

Typical floor plans for the typical floor with the architectural consideration were given priority to ensure standards and creativity. The technical feasibility was carried out for the selection of a plan and then the financial feasibility and market feasibility were carried out for the selected plan of typical floor with around 40 no of floors.

The project did not require a Environment Impact assessment (EIA) study according to the regulations, therefore Initial Environment assessment (IEE) was initiated with environmental consideration for the project and it was proposed and finalized to establish a separate water treatment plant for Sky residencies. At the same time Traffic Impact Assessment (TIA) was carried out to evaluate the feasibility of vehicle movement and improving the existing conditions which was actually done after finalizing the number of car park slots and floors.

Then the idea of having recreational floors at alternative locations was proposed and it was finalized with one recreational floor with all required facilities between the car park floors and the apartment floors

After finalizing the floor arrangements and number of floors, the designs for services was initiated with possible alternative considerations such as use of break pressure tanks or pressure reducing valves for water supply or whether to use sky lobby or Dis zoning for vertical circulation. After finalizing services it was decided to start structural design of required elements.

The structural designs were done for columns, beams, slabs, shear walls, car park slabs, rooftop water tank, water sump, swim pools which are the critical structural elements of the building. At the same time the analysis using SAP2000 software was also commenced and the failure modes were considered and section sizes were changed to enhance the structural stability of Sky Residencies.

With the finalization of building orientation, dimensions and appearance, architectural drawings and 3D modeling were carried out using Google sketch up and Lumion 4.

The most challenging aspect of the whole designing process is planning for sustainable development and alternative selection. The green concept is prioritized in every process of this project and the alternative selection led to more and more options. With the sustainable solutions Sky Residencies will be most suitable for the upcoming era.



**Figure 1.1 Location of the Site**



**Figure 1.2 View of the building**

## 2. FEASIBILITY STUDY

In order to evaluate the feasibility of the project which is proposed at the pre-owned land of the client, several development scenarios were considered. Multiple combinations are analysed in order to choose the best alternative.

Development scenario factors

- Building function-Residential/commercial/Hotel
- Building form-shape-3 alternative shapes , height- low-rise/high-rise,
- Building main facilities-recreational spaces, restaurants & shopping malls.

The best alternatives are chosen by comparing the development scenarios with respect to the following feasibilities.

- Social and environmental feasibility
- Technical feasibility
- Market feasibility
- Financial feasibility

### 2.1. Building function selection

3 common building functions will be considered in this report. They are,

1. Residential
2. Hotel
3. Commercial



University of Moratuwa, Sri Lanka.  
Electronic Theses & Dissertations  
[www.lib.mrt.ac.lk](http://www.lib.mrt.ac.lk)

#### 2.1.1. Zoning regulations

The site is located in the residential zone according to UDA City of Colombo development plan 2008.

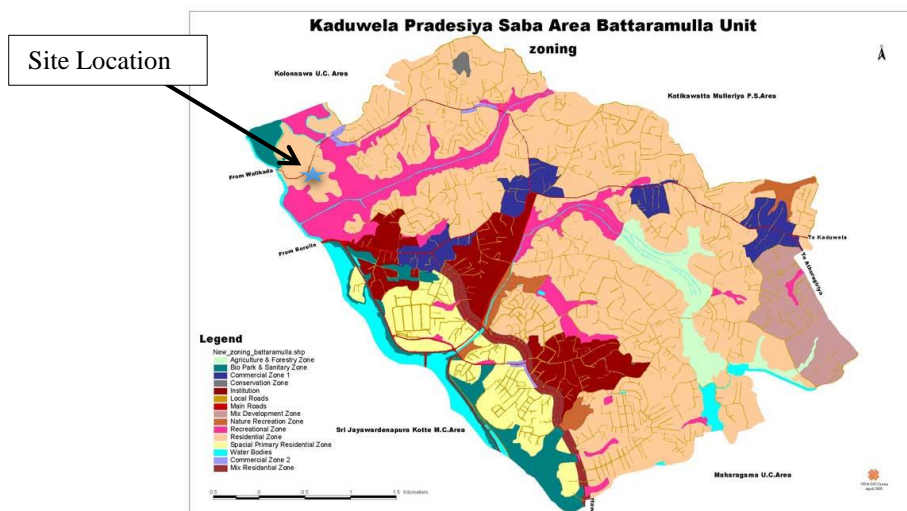

Figure 2.1 Zoning Regulations

The allowed types of developments in residential zones are

- Dwelling houses/Units ,Apartment buildings
- Banks, Professional Offices-Each of net floor area not exceeding 200 sq.m., each within sites of extent exceeding 500 sq.m. Retail shops not exceeding a floor area of 100 sq.m.
- Retail shops not exceeding a floor area of 100 sq.m. etc.

Hence large hotels and multi storied office buildings are not feasible.

### 2.1.2. Social feasibility

The surrounding area is mainly residential with low building density. Several condominium developments such as Fairmount and sky garden are nearby. Introduction of hotel to this place would create a lot of resistance by the communities around the area. Commercial developments are also not adaptable to the community.

The natural beauty around the area is an advantage for a hotel or residential project because more customers would feel comfortable to stay here. The Perera mawatha is a narrow road which cannot bear higher traffic. Since Commercial buildings and hotels would create a lot of traffic. That will create resistance by the people who are already living there.

### 2.1.3. Environmental feasibility

Hotel project or residential project would produce a lot of waste water and solid waste. Commercial project is better in terms of the amount of waste produced. Water treatment plant and solid waste management plans should be used if residential or hotel projects are chosen.

The power consumption levels will be more or less similar. Hotel or commercial building would need all spaces to be air conditioned. But residential building would need only some rooms to be air conditioned and most of them would not be at operation in daytime. Hence power consumption would be less in apartment building function.

High traffic due to commercial or hotel projects would create a lot of noise pollution and hotel project would need bars, night clubs which produce noise. This would change the calm environment in this area.

### 2.1.4. Technical feasibility

Assuming 40-50 storied building, the land used by the buildings will become significant. Hence there will not be enough space to cater the demand for parking. Residential commercial and hotel projects would need 5, 7 and 8 floors of parking respectively for 40 usable floors. Hence residential is a more feasible option. The restriction on building size by the government regulations indicate residential buildings are more suitable.

## 2.1.5. Market Feasibility

### Apartments

#### *Market*

Unlike most emerging economies, the urban population in Sri Lanka has not increased in accordance with the increase in population over the past five decades and currently, only 15 percent of the population live in cities. Most condominium properties has an average pre-construction sale ratio of around 50 percent. Some of the more prestigious developments like the Empire, Emperor, Lumiere and Trillium tend to sell around 80 percent of their units by completion of construction. (Source: Sri Lanka real estate market brief: KPMG, 2012)

Rajagiriya is near to all major Offices in Colombo. Two major schools (Hewawitharana Central College and President's College) are located within 3km range of the area. All popular schools in Colombo are in 30 minute drive range. In the consideration of competitors there are several high-rise apartments available such as Fair Mount, Sky garden and several projects in the construction. But none of them have are in the prestigious level as Empire, Emperor etc.

#### *Feasibility*

After considering existing market condition for apartments and analysing the competition, apartments can be feasible when comparing with other two options. Opportunities in this market is significant and threats are low due to competition and other external factors. Since considerable demand is present for the apartments in Rajagiriya if we can offer an apartment for a price in the range of 20-40 Million the project will be competitively beneficial.

### Offices

#### *Market*

Rajagiriya are is home for many government and private offices. Currently there are several high-rise buildings providing office facilities in the surrounding area. Most of them are facing Sri Jayawardenepura road and other major roads. Better access and proper parking facilities gives the competitive advantage for office buildings

#### *Feasibility*

The selected location for the proposed building is in Perera Mawatha in Buthgamuwa Road. Even Buthgamuwa road is a major road and when it comes to road condition it's not sufficient for a high-rise office building because it will need a good access and transport facilities. Since Perera Mawatha is a residential area, public transport and due to social aspects offices are not feasible.

### Hotels

#### *Market*

Diyawanna Lake is the major tourist and local traveller's attraction in this area. Water's Edge, one of the 5 star hotels in Sri Lanka is located in the area. It has a monopoly in tourist and hotel industry in the area. Large recreational area is the core competency in most of the hotels located in the area.

#### *Feasibility*

When it comes to Perera Mawatha in Buthgamuwa road the land area available does not gives an advantage for a hotel. Purpose of high-rise hotel will be to give access the tourists to travel around Sri Lanka and use the hotel as a hub. Rajagiriya is not a tourist hub. When it comes to transport facilities it is not up to the standard. As the Water's Edge hotel we do not have a huge land area or the advantage of Diyawanna Lake. Hence it seems les feasible.

Considering above factors what we can see is the most feasible and practical option according to the market is Apartments. With the competitive aspect, Environmental aspect, market aspect it is the preferred option available.



Figure 2.2 Selection of function

## 2.2. Selection of Building Form

3 shapes

- Alternative 1: 4 apartments per floor irregular shape
- Alternative 2: 6 apartments per floor
- Alternative 3: 4 apartments per floor regular shape



Figure 2.3 Alternative 1

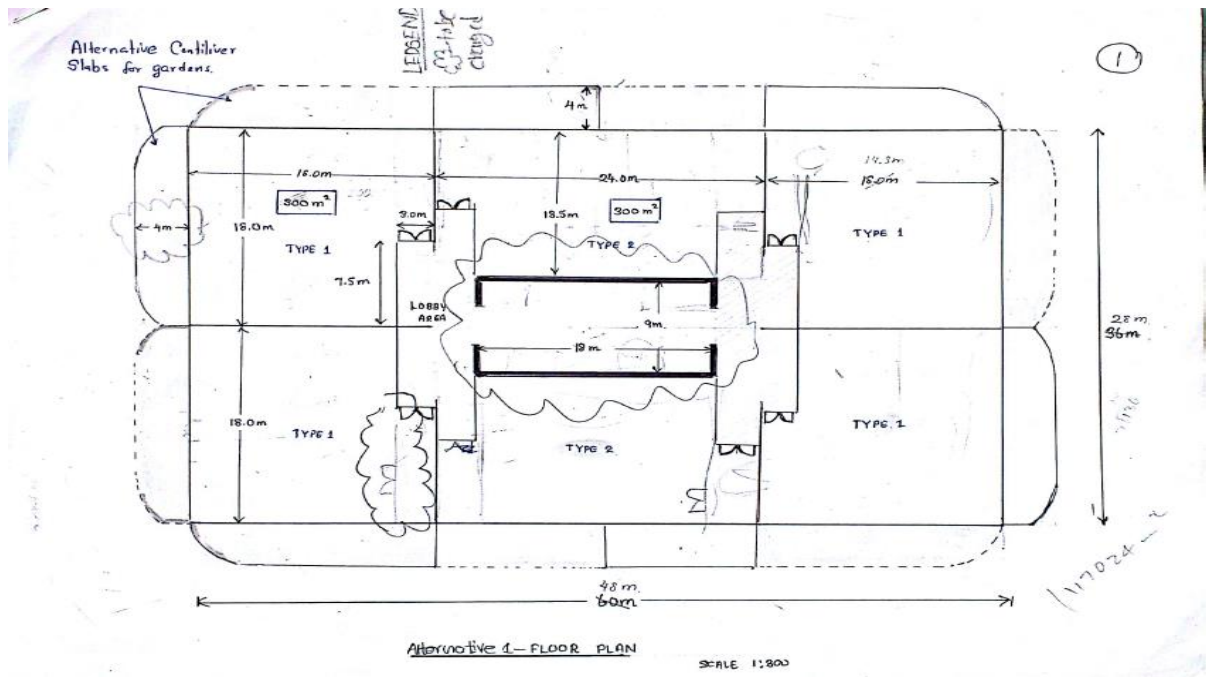

Figure 2.4 Alternative 2

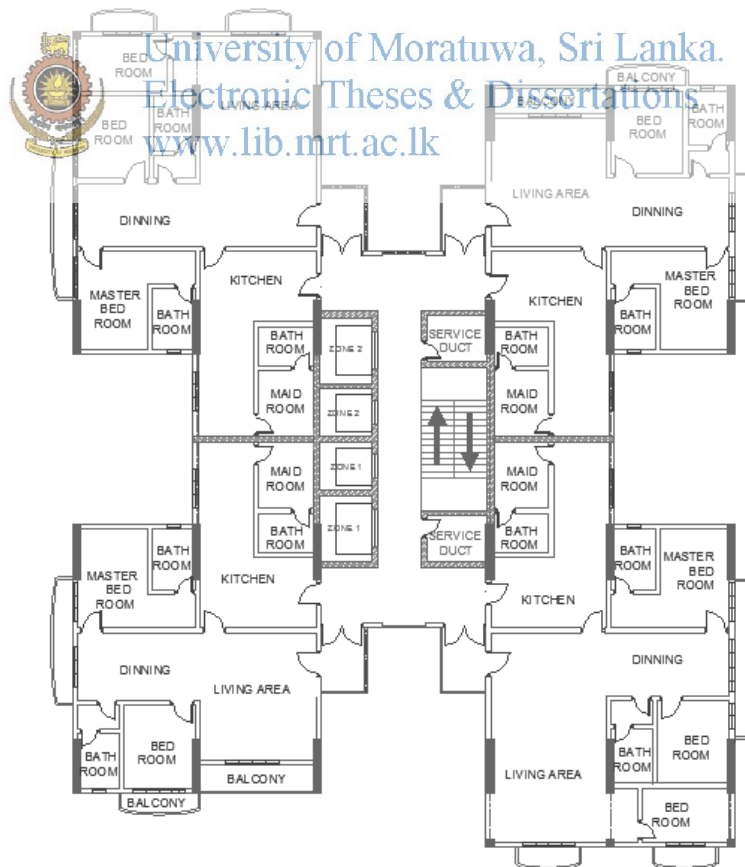

Figure 2.5 Alternative 3

**Table 2.1 Comparing Alternatives**

	<b>Alt 1</b>	<b>Alt 2</b>	<b>Alt 3</b>
<b>Advantageous</b>	<ul style="list-style-type: none"> <li>• The land is consumed well</li> <li>• Unique aesthetics</li> </ul>	<ul style="list-style-type: none"> <li>• Less number of floors ( Alt1 or 2 40 floors = Alt 3 27 floors)</li> <li>• Less number of lifts</li> <li>• Less maintain ace and construction cost because of straight walls</li> <li>• More Usable floor area</li> </ul>	<ul style="list-style-type: none"> <li>• Enchased natural light availability.</li> <li>• High flexural rigidity of the building</li> <li>• No requirement of transfer plate above car park level</li> <li>• Less service area (19%)</li> <li>• Competitive advantage of the height</li> <li>• Less maintain ace and construction cost because of straight walls</li> <li>• More Usable floor area</li> </ul>
<b>Disadvantageous</b>	<ul style="list-style-type: none"> <li>• The corner spaces with acute angles are hard to use.</li> <li>• Difficulty to construct: high construction cost</li> <li>• Requirement of a transfer plate above car parks</li> <li>• Difficulty in maintenance</li> </ul>	<p>University of Moratuwa, Sri Lanka. Electronic Theses &amp; Dissertations www.theses.mrt.ac.lk</p> <ul style="list-style-type: none"> <li>• Type 2 rooms do not have adequate sunlight</li> <li>• Higher land use: no adequate space for recreational activities/greenery</li> <li>• Competitive advantage of tallest buildings cannot be gained.</li> <li>• Requirement of a transfer plate above car parks</li> </ul>	<ul style="list-style-type: none"> <li>• Building height: vulnerability to dynamic lateral loading</li> </ul>

Alternative 3 has been chosen considering higher number of advantages over disadvantages.



### 2.3. Building height selection

According to real estate market brief 2012 by KPMG there is a huge demand for high end apartments. One of the characteristic of high end apartments is that they are tall. The number of stories of the building plays a vital role in marketing. People feel prestigious to make an apartment of one of the tallest buildings their home. On the other hand the view of an apartment is very important for marketing. The clear sight of the surrounding area increased with increasing height of the building.

We have to adopt bored pile foundations when the building is more than 15 storied tall. The pile cost increase per unit floor increased is reducing with increasing number of floors. Hence it is financially beneficial to have a taller building when the piles are used. In this land area, possible building dimension would be about 35m in short direction considering the UDA regulations. Buildings with height to width ratio of 1:5 or more are considered as slender buildings according to Australian standards AS1170.0 2002.

Hence the maximum height allowable without being slender is 175m (49 floors).

Existing tallest residential building is the on three20 tower & it is only 38 floors tall whereas the tallest existing building (Hyatt regency) is 45 storied tall. Most of the proposed tallest building projects are residential projects which shows the high demand. If the building is around 46 or more stories tall it will become one of the 5 tallest buildings by the end of the construction period. Considering the market for tall buildings, pile cost fraction reduction, slenderness and UDA regulations the most feasible number of stories is chosen as 46 stories.

Table 2.2 Details on existing tallest buildings in Colombo

Building	Num. of Floors	Type	Year
Hyatt regency	45	Commercial	2015
World trade Centre	39	Commercial	1996
OnThree20	38	Residential	2014
GS Towers	36	Mixed	2010
Emperor	35	Residential	2011
Hilton residencies	34	Mixed	1997

Table 2.3 Details on proposed tallest buildings in Colombo

Building	Num. of Floors	Type	Year
Altair	68	Residential	2017
ITC Colombo 1	55	Residential	2018
Shangri-La towers	51	Residential	2017
Abans silver needle	48	Mixed	2018
The Destiny	44	Residential	2017

## 2.4. Feasibility of Facilities

The feasibility of facilities for 46 storied condominium development are evaluated to choose the facilities which suit the best.

### Recreational areas

Recreational spaces must be provided to attract buyers for the apartments and to make it more social friendly for the people who live in the apartments. Most condominiums are having recreational spaces at its top floor and at the ground floor. This building is having an extended base in parking floors. The top of the parking floor can be used as a recreational space. Swimming pools, restaurants, areas for indoor sports etc. can be provided.

### Restaurants & shopping malls

Restaurants & shopping malls are important to market the project. It would be more comfortable for the people who lives their when groceries and food are close at hand. If shopping mall would have to be at the ground floor level. There will be a lot of external traffic introduced by this. The parking requirement for apartments are too high already. Hence shopping malls are not a feasible option. Restaurants can be placed at recreational space in upper floors as no outside people will be attracted.

## 2.5. Financial feasibility of proposed development

Selecting a Discount Rate for Net Present Value Calculation

- 10 year government bond (Sri Lankan) rate Issued in 2015 January = 7.88%
- 10 year government bond (Sri Lankan) rate issued in 2014 January= 8.6%

Government bonds is a low risk (free risk) investment which gives a constant return. This can be taken as the discount rate (Alternative investment rate) for NPV calculation.

Hence let's take a discount rate of 9% for the NPV calculation.

We have assumed total cost of investment is done at year 0 for the worst case scenario and to compare with one time investment NPV values such as government bonds fixed deposits and share.

**Table 2.4 Estimated Cost for Financial Feasibility**

<b>Project Cost</b>		
<b>Development Cost</b>		
Land	Rs. 1 million per Perch( 180 perch)	180,000,000.00
Approval Fees		1,000,000.00
Soft costs		
Architectural	(1% from Budgeted total cost)	40,000,000.00
Engineering	(2% from Budgeted total cost)	80,000,000.00
Professional Fees		4,000,000.00
Marketing		3,000,000.00
Construction fees	(Rs. 7500 per sq ft, 9400 sq ft 41 storey)	3,190,500,000.00
Taxes and Insurance		558,337,500.00
Contingencies		5,000,000.00
<b>Construction Interest</b>		
Permenant Loan	(Assumed Rs. 1 Bil )	1,000,000,000.00
Construction interest		11%
Interest		110,000,000.00
<b>Total Project Cost</b>		<b>4,171,837,500.00</b>

Before the investment decision is made it is essential to consider the return the investors getting out of their Rs. 4 billion investment. In this proposed 46 storey building of apartments Rs. 1 billion is financed by a long term loan and rest is invested by shareholders. When we consider the budgeted costs and returns it is profitable. But when making the investment decision investor needs to consider the present value of their return of the investment and the rate of the return. Hence by considering a discount rate of 9% we have calculated Net Present Value (NPV) and Internal Rate of Return (IRR).

In this Rs. 4 billion huge investment investors get a NPV of Rs.405 million after 5 year period. That is more than 10% from the initial investment. When it comes to other possible investments this is a profitable and certain investment. This value is obtained by taking an average selling price of Rs. 35 million. But in reality we are planning to categorize the apartments in to different selling price of Rs. 35 million- 45 million. For the calculation we have taken the minimum value of that. NPV value after 5 years positive tells it is profitable than investing in bank or other financial investments. The rate of 9% is arrived from government bond rates of 10 years. 5 year bonds are way less than that. Since it is a significant amount this gives the investors low risk of lose and high probability of making a favourable return out of their investment in short-term.

**Table 2.5 NPV IRR Calculation**

Year	Construction Period				Operational Period	
	1.00	2.00	3.00	4.00	5.00	
Initial Investment Rs.	(4,171,837,500.00)					
Sales( No. of Apartments)	-	40.00	40.00	40.00		
Returns(Average Rs. 35 Mil per Apartment) Rs.	-	1,400,000,000.00	1,400,000,000.00	1,400,000,000.00	1,400,000,000.00	
Profit on Management Activities Rs.				30,000,000.00	30,000,000.00	
Year Net Return Rate	(4,171,837,500.00)	1,400,000,000.00	1,400,000,000.00	1,430,000,000.00	30,000,000.00	
Present Value (9% Rate)		0.09				
Net Present Value	(4,171,837,500.00)	1,284,403,669.72	1,128,351,990.57	1,081,056,872.09	1,013,048,051.82	
IRR	404,521,025.80					
	0.13					



University of Moratuwa, Sri Lanka.  
Electronic Theses & Dissertations  
www.lib.moratuwa.ac.lk

We arrived at above NPV and IRR value based on following sales estimations

- In year 1 : 40 apartments pre-ordered
- In year 2 : 40 apartments pre-ordered

- In year 3 : 40 apartments pre-ordered
- In year 4 : 40 apartments pre- ordered

Our planned market strategy is to sell maximum number of apartments in the initial years. It will reduce the risk for pay back. Currently the investment have a discounted pay back of 3.6 years. It is a very favourable payback of investment when we consider a huge investment like Rs. 4 billion.

As per internal rate of return of the investment for a 5 year period is 13 %. If we consider the safest investment of money which is a fixed deposits or government bonds with a very low risk factor they only provide a rate of return in the range of 7-9% maximum. But by investing in this 46 story building investor can get a rate of 13% which is about 5% higher than the fixed deposits and government treasury bills. This value shows a very low level of risk. When we consider other investment IRR values in the market they can only get to about 12%. This gives a competitive advantage to the investments. Since after the civil war in Sri Lanka with the huge economic growth, real estate industry is a very low risk industry which gives the return of the investment compared to other industries such as hotel, transport, communication and other fields. Finally the conclusion we could arrive is investing in this apartment building is high profitable and low risk when analysing the budgeted data. In this rising market investing in this project has a significant benefit to all investors.



University of Moratuwa, Sri Lanka.  
Electronic Theses & Dissertations  
www.lib.mrt.ac.lk

### 3. INITIAL ENVIRONMENTAL EXAMINATION

#### 3.1. Selecting EIA or IEE

When we consider EIA regulations published on [www.cea.lk](http://www.cea.lk), order published under the Gazette Notification No. 772/22 dated 24.06.1993,

Only “prescribed projects” are required to be subjected to IEE / EIA. The list of prescribed projects requiring an IEE / EIA under the provisions of the National Environmental Act as contained in the Gazette are given below ([www.cea.lk](http://www.cea.lk)).

In the housing and building section there are some regulations cancelled with the new gazette. Sky residencies project is not a prescribed project according to this section of the regulation

In part 3 of the regulation,

Proposed project is not within 100m from the boundary of any area declared by,

- the National Heritage Wilderness Act No. 3 of 1988,
- the Forest Ordinance
- whether or not such areas are wholly or partly within the Coastal Zone as defined in the Coast Conservation Act, No. 57 of 1981

It is not within the following areas, whether or not the areas are wholly or partly within the Coastal Zone:

- Any erodable area declared under the Soil Conservation Act (Chapter 450).
- Any Flood Area declared under the Flood Protection Ordinance (Chapter 449) and any flood protection area declared under the Sri Lanka Land Reclamation and Development Corporation Act, No.15 of 1968 as amended by Act, No. 52 of 1982

It is 50m away from manmade small canal a branch of Kolonnawa canal which has a max width around 4 meters. It is mentioned in the regulation the project is prescribed project if its 60 meters from the bank of a public stream as defined in the Crown Lands Ordinance (Chapter 454) and having a width of more than 25 meters at any point of its course. Hence it also do not make the project prescribed.

### 3.2. Terms of Reference for the IEE: Attached to annex

## 3.3. INITIAL ENVIRONMENTAL EXAMINATION REPORT

### Executive Summary

Green Consultants (Pvt) Ltd is expected to design a high rise building targeting luxury residential apartments in 180 perch area in Perera Mawatha Rajagiriya. Colombo is experiencing a mass expansion of construction industry in this decade. In order to cater this demand Colombo is now coming up with multi storied buildings like never before. Rajagiriya is one of the most calm and ecofriendly cities in Colombo district.

Green Consultants (Pvt) Ltd is a consulting firm which facilitates engineering solutions for government and private sector which was established in 2010.

Colombo city is the heart of Sri Lanka which a high density of population and highest number of population. With the development population density in Colombo and its suburbs have been increased rapidly and with the scarcity of land it is profitable economically and environmentally if we go for high rise buildings. As a company which focuses in sustainable development Green Consultants (Pvt) Ltd is proposing 47 story high-rise apartment complexes for luxury resident purposes.

This is not a highly environmentally sensitive area so as according to the identification of the existing environment. This is not an highly residentially populated area so most operations are going in the day time so the main concern is to minimize the generated impacts during the day time. Mainly identified impacts are noise, vibration, dust, solid waste and waste water generation, high traffic generation during peak hours...etc. so relevant and most suitable measures are proposed for mitigate those impacts.

## 1. INTRODUCTION

### 1.1 Objectives of the IEE report

Main objective of this IEE report is to identify the existing environment of the proposed project area and check whether that there will be any adverse changes to the existing environment due to the project implementation and make suggestions to minimize those adverse impacts to the environment due to this project.

In detail, the IEE report will address on certain areas such as Physical, Biological and Ecological, Socio-economic aspects in a broader view. Anticipated environmental impacts that will arise due to project activities and the necessary measures that have to be adopted to mitigate them are descriptively illustrated in the IEE report.

### 1.2 Background of the project

Availability of the land is the one of main problem in the commercial towns like Colombo and its suburbs. Because of the scarcity of the available lands for the construction, newly innovated trend is to go for the high rise buildings which will save the land usage by considerable amount same time increasing the cost. Now in Sri Lanka there are several high rise buildings, some of them are already operating in well manner some are is ongoing their construction. Most of those high rise buildings are used as office buildings and apartment buildings for example Crescat, Fair Mountain, Sky Garden can be identified.

SKY Residencies (pvt) ltd is brought the land which is located in Rajagiriya which is near to the Buthgamuwa Road with the 6.911510° longitude and 79.904998° latitude approximately 180 area of perches. To develop the land, SKY Residencies handed over the project to the Green Consultants (pvt) Ltd. to come with suitable building project. According to the current trend and the feasibility test carried out by the Green Consultancies they proposed to construct a high rise building with consisting of apartments since they identified that it is more financially and technically feasible also current need. Since because of the scarcity of available land SKY Residencies approved the project.



### 1.3 Objectives and justification of the project

- Make use of the available land up 100% efficiently.
- Constructing of iconic high-rise building which can be used as a apartment building which will consisted of 160 apartments with luxurious facilities such as swimming pools.gym, restaurant...etc.
- Adapt the green concept to the building during its construction and also its operational stages.
- Provide high facilities to the residents of the building while maintaining the safety of the residents.
- Protect the environment same time contribute to the economic development.

It can be clear seen that high rise buildings are necessary to make sure to have a shelter for each and every citizen in the Democratic socialic republic of Sri Lanka. During the last decade there is an high population growth rate in Sri Lanka since because that there will be a scarcity of the available land in near future. To overcome those it is quite justifiable to construct the high-rise buildings it may become very popular in Sri Lanka near future. In most developed countries, it is a common trend to go for the high-rise buildings to take the maximum opportunity from the land to secure the available land for other activities.

### 1.4 Extent and scope of the study

Initial Environment Examination is carried out as a requirement of the laws and regulations implemented by the Central Environmental Authority. Initial Environmental Examination covers the all 180 perches of the project area.

The scope of the study can be outlined as follows,

- Field data collection regarding physical, social, economic and environment background
- Public consultation with affected people and other relevant authorities
- Preparation of Basic Information Questionnaires (BIQs) and submission to CEA (Central Environmental Authority) for environment clearance
- Preparation of Leopold matrix for identifying the major impacts
- Assessment of potential Environmental impacts and development of preventive and/or mitigation measures for significant impacts,
- Preparation of Environmental Management Plan (EMP) and Environmental
- Monitoring Plans
- Preparation of consolidated Initial Environmental Examination (IEE) repor

### 1.5 Structure of the IEE Report

## Outline of the IEE report

### Executive Summary

1. Introduction
2. Description of the proposed project and reasonable alternatives
3. Description of the existing environment
4. Anticipated environmental impacts due to proposed project
5. Proposed Mitigatory Measures
6. Contingency Plan
7. Monitoring Programme
8. Conclusions and Recommendations

### Annexes

- I. Terms of Reference
- II. Sources of data and information
- III. References
- IV. List of preparers including their work allocation
- V. List of persons / organizations contacted

Complete set of relevant maps, charts, layout

## 1.6 Preliminary approvals needed for the project and any conditions laid down by state agencies in granting preliminary clearance for the project

Following laws and regulations are applied to the project



University of Moratuwa, Sri Lanka.  
Electronic Theses & Dissertations  
www.ltk.mrt.ac.lk

Table 3.1 Laws and Regulations

Laws and Regulations	Provisions and main content
National Environmental Act No.47 of 1980, Amendment No.56 of 1988, and other Amendments	The NEA is a framework environmental statute that makes provision for protection, management and enhancement of environment, for regulation, maintenance and control of quality of environment and for the prevention and control of pollution by implementing the proposed project.
National Environmental (Noise Control) Regulations No. 01 of 1996	Regulates maximum allowable noise levels for construction activities during proposed project activities
National Environmental (Protection & Quality) Regulations, No. 01 of 1990	Provides standards for discharging effluents into inland surface water during proposed project activities.

Fauna and Flora Protection Act (1993)	An act to amend the fauna and flora protection ordinance (Chapter 469) of 1938, which provide for the protection and conservation of fauna and flora of Sri Lanka and their habitats; for the prevention of commercial and other misuse of such fauna and flora and their habitats for conservation of biodiversity of Sri Lanka; and to provide for matters connected there with or incidental threat
Felling of Trees Control Act No. 09 of 1951 as Amended through Act No. 30 of 1953	This Act sought to prohibit and control felling of specified trees (mainly intended to stop indiscriminate felling of specified trees) in the country.
 <p>University of Moratuwa Sri Lanka Electronic Theses &amp; Dissertations www.lib.mrt.ac.lk</p>	Control, regulation and development (including conservation and utilization) of water resources; prevention of pollution of rivers, streams and other water resources; formulation of national policies relating to control and use of water resources.
Soil Conservation Act, No. 25 of 1951 Amended in 24 of 1996	An act to make provisions for enhancement and substances of productive capacity of soil, to restore degraded land for prevention and mitigation of soil erosion, for conservation of soil resources and protection of land against damage by floods, salinity, alkalinity and drought and to provide for matters connected there with or incidental thereto
Flood Protection Ordinance No. 04 of 1924	An ordinance for protection of areas subjected to damage from floods. This includes declaration of flood areas, preparation of schemes for flood protection and other rules and regulations regarding flood in the country

<p>Regulations of Local Authorities</p>	<p>Regulates and control actions and methods taking place within the command area relevant to government laws and regulations.</p>
---	--

**2.0 Description of the proposed project and reasonable alternatives**

**2.1 Description of the project**

**2.1.1 Project Location**

District – Colombo

Local Authority – Kaduwela Municipal Council

Divisional Secretariat – Colombo



**Figure 3.1 Site Location**

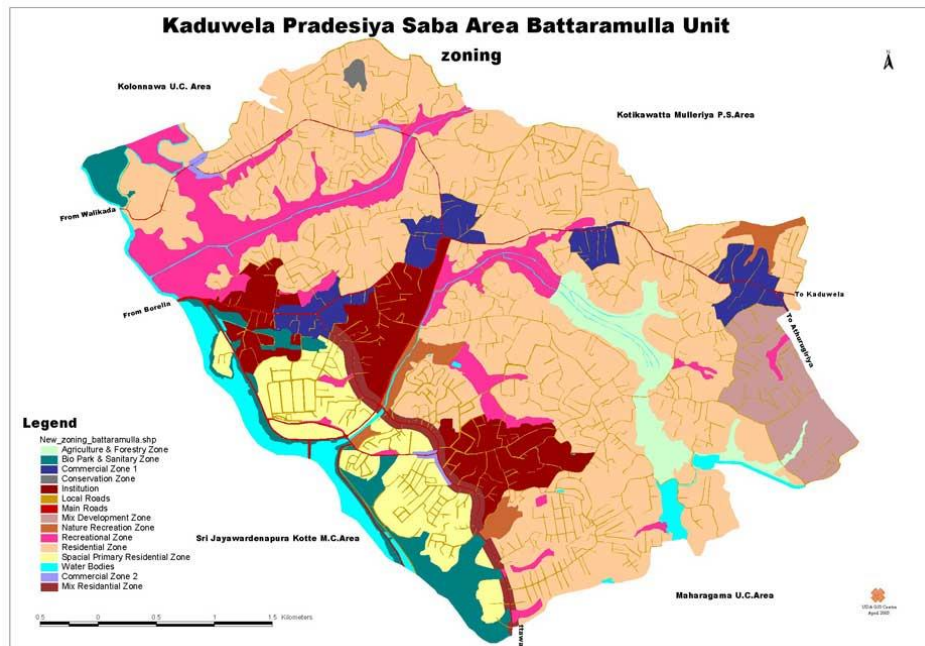

**Figure 3.2 Location of site in Kaduwela Division**

This area is partially urbanized and there are many business buildings nearby. The Access road the Perera Mawatha is maintained by RDA and so as the Buthgamuwa road. There are several high-rise buildings near by the proposed location such as Fair Mount and Fairways.

Project site spread over 180 perches and site is owned by the Sky Residencies (pvt) Ltd.

**2.1.2 Project Layout**

Following picture will highlight the major components of the project and the accessibility to the project site.

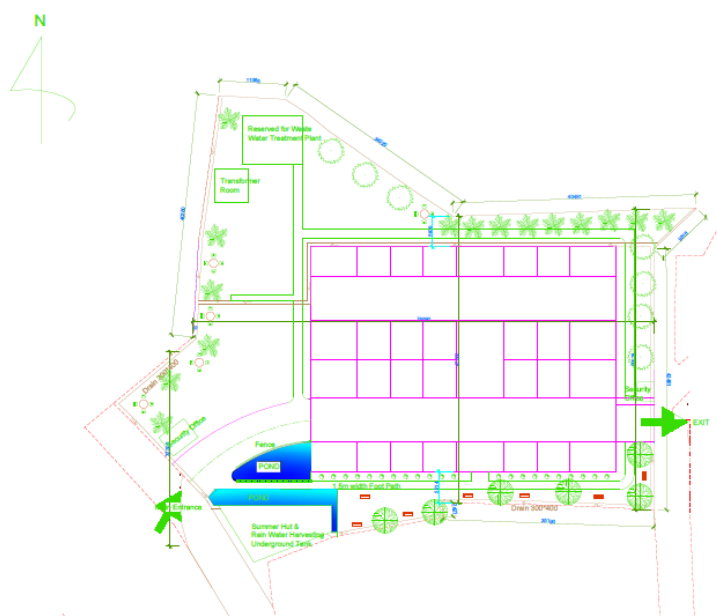

**Figure 3.3 Site Layout**

### 2.1.3 Brief Description on all major components of the project

#### 2.1.3.1 Permanent Structures

Project included following permanent structures

- **Car Parking floors** - Car Parking floors are placed from ground floor to 4<sup>th</sup> floor with having capacity for 265 vehicles at once. Both Lift and Stair cases are provided to for the entrance to the car parking. One car parking floor is connected with other parking floor with a ramp of 7.3m width. Total floor area of the car parking floor is 1856 m<sup>2</sup> . Dimensions of the one car parking slot is 2.5m \* 5m.
- **Recreational Floor** – Just after the five car parking floors there is a recreational floor consists of the swimming pool and the restaurant for residents and also a gymnasium with full facilities.
- **Apartment floors** – After the recreational floor there is 40 apartment floors. One apartment floor consists of four apartments. Two of them are two bed room apartments and other two are three bed room apartments. One typical apartment consist of two or three bed rooms with bath rooms , Kitchen, living room and a maids room. Service core is placed at the middle portion of the apartment floor in order have an easy access. There are two separate entrance for each apartment as main entrance and the entrance through the kitchen mainly for the used for maid and for waste disposal activities.
- **Gardening area** – mainly consists of the summer hut, walkways benches and also with water pond. Most of the ground area is covered with green vegetation.
- **Waste water treatment Plant** – All the waste water collected from the apartments goes through a treatment process and the supernant water will be used for gardening and also extra amount will be discharged in to the Kollonawa Lake
- **Gymnasium and the Restaurant** – Located in the Recreational floor having all the meal facilities for the residents from 7.00 am to 11.00 pm. Gymnasium can be used by the residents which will be opened from 6.00 am to 9.00 pm.

- **Swimming pool** – Swimming pool facilitate is provided for all the residents throughout the day.

### 2.1.3.2 Temporary Structures

Most of the temporary structures are planning to have in the construction stage.

- Billets – Laborers billets are going to placed one corner side of the land to prevent the most of the social conflicts with the neighbors.
- Contractors and Engineers Site Office
- Contractor's store Building, store yards , dumping sites will be in separate locations.

### 2.1.4 Methodology of Construction

Following procedure is followed in the construction

- Site Preparation
- Constructing the temporary structures such as billets and site office
- Excavation for piles
- Pile inserting
- Erath Filling
- Compaction
- Superstructure construction
- Final Finishes such as painting
- Landscaping



University of Moratuwa, Sri Lanka.  
Electronic Theses & Dissertations  
lib.mrt.ac.lk

No need of resettlement of people in this project but only compensate the neighbors.

As according to the site topography no need of any slope protection.

All the materials are brought out from the outside.

### 2.1.5 Methodology of Operation

- Water Supply – Water supply is taken from the National Water Supply and Drainage Board
- Electricity – Electricity is supplied from the Ceylon Electricity Board
- Repairs and Maintenance – There will be a separate crew for the maintenance of the building which will be recruited by the Sky Residencies (pvt) Ltd.
- Solid Waste Management – All the solid waste is collected through a refuse chute those collected solid waste is collecting by the Municipal Council

- Waste Water – All the waste water collected in the apartments are collected and followed through a treatment process and discharge in to Kolonnawa Lake
- Fire Fighting System – Fire Extinguishers, Hose reels, Wet riser system is applied to the building to protect it from the sudden fire.
- Storm Water – There is a rain water harvesting system to collect storm water

### 2.1.6 Proposed Schedule for the Implementation

Present Feasibility and Detailed Engineering Design of the project will be completed in May 2015. Once Detailed Designs and Bid Documents are completed, tenders will be awarded to the successful contractors at the beginning of 2016. It is planned to finish the all constructions within Three years.

### 2.1.7 Work Force

Total work force need for the construction will be estimated as averagely 250 people per day

## 2.2 Evaluation of Alternatives

Mainly in the feasibility Studies it is identified different types of alternatives with relevance to the project purpose. Since the land and location cannot be changed.

Proposed Project – Apartment Building

Alternative 1 - Office building

Alternative 2 – Hotel with Apartment

Alternative	Apartment Building	Office Building	Hotel with Apartment
Cost	1	2	3
Impacts to the environment	1	2	3
Reliability	1	3	2
Suitability	1	2	2

**Table 3.2 Comparoson of Alternatives**



### **Office, Hotel or Commercial Building**

These functions will generate higher traffic flow to this area. Number of parking requirement is difficult to calculate because it will vary. This land is very small and access road is very narrow. Therefore, it is difficult to provide parking.

These will generate high population near this land that is surrounded by private land allotments. It will cause lot of noise and social issues as well. If we consider a hotel complex there will be foreigners as well. There will be different kind of people gathering around this area. This will generate cultural issues.

These functions require lot of energy for lighting, air conditioning etc. It will be difficult to provide passive techniques to give thermal comfort. It will increase carbon footprint of the building.

### **Apartment building**

We know the number of apartments so that we can provide adequate parking spaces.

Since these are small apartments, we can provide passive techniques for thermal comfort reducing the energy demand and carbon footprint.

These apartments are luxury apartments so that only rich people will afford. Therefore, there will not be much cultural issues.

All the numberings are show the sequence of suitability of each alternative

## CHAPTER 3 – DESCRIPTION OF THE EXISTING ENVIRONMENT

Mainly land covers a 180 perches of land area. This area may not be highly sensitive area. Most commonly this is an urbanized area with number of high rise buildings and nearby shanties.

### 3.1 Physical environment

#### 3.1.1 Topography

This land is an almost flat land. There were not any significant changes in topography.

#### 3.1.2 Geology & Soil

At the top sandy clay soil layer is encountered. When going deeper peat soil layer is encountered with high water table as according to the geological investigation in some locations of the land water table is just coincide with the ground level.

#### 3.1.3 Meteorology

Mainly this area belonging to the wet zone hence because of that from December to January there will be higher rain falls. Average rainfall can be noticed as 1500 mm/year according to the meteorological data. From March to September there are dry seasons but these climates are change due to local climate changes sometimes.

#### 3.1.4 Hydrology

There will not any significant flash floods nearby areas for certain history. Although there is wetlands within 50 m from the site which may use to mitigate the flash floods and dissipate and collecting excessive rain water. Mainly ground water is not used most of the people use the municipal water supply to fulfill their day to day needs. High ground water table can be identified in some locations in the site averagely high ground water level may encounter.

#### 3.1.5 Land use

Most of the lands are used as residential areas some of them are high rise buildings and most of them are shanties and looks like slumps. According to the land use it can be identified as semi urbanized area. Few commercial buildings can be identified.



**Figure 3.4 Existing Environment**

**3.2 Biological / Ecological environment**

Since there are wetlands area near by it is quite high with biological and ecological species there are certain endemic flora and fauna within those wetlands. Mostly there are high amount of avi fauna also some migratory avi fauna which may centered on the wetlands.



University of Moratuwa, Sri Lanka.  
Electronic Theses & Dissertations  
[www.lib.mrt.ac.lk](http://www.lib.mrt.ac.lk)



**Figure 3.5 Figure 3.7 Existing Environment**

### 3.3 Social and archaeological environment

There were not any archaeological sites that can be identified with the nearby area. Most of the time quite and clam area, since both luxurious high rise buildings and the small slums are located in same area mix culture is prevailing. There were not any reported social conflicts up to now



Figure 3.6 Existing Environment  
University of Moratuwa, Sri Lanka.  
Electronic Theses & Dissertations  
www.lib.mru.ac.lk

## CHAPTER 4 - ANTICIPATED ENVIRONMENTAL IMPACTS DUE TO PROPOSED PROJECT

Leopold matrix method is used as the EIA methodology to identify the possible impacts that may highly affect to the environment due to implementing this project. Modified Leopold matrix is attached to the report.

As according to the modified Leopold matrix, following negative impacts are highly affected to the environment,

- Ground soil can be disturbed due to geological investigation, site clearing, providing temporary sanitation facilities.
- Surface water may affect due to waste water discharge, chemicals use for maintenance activities and due to weed control methods
- Ground water may also affect due waste water discharge, providing temporary sanitation facilities.
- Air may get polluted due to construction material like soil and quarry dust, also the toxic substances from the paints.

- Noise emanating from the construction work may be one of the major impacts in this which can be highly affected since there are several resident houses nearby site.
- Vibration may also affect and there may be certain damages to the nearby residencies due vibration induced during pile inserting and also during preliminary geotechnical investigation.
- Hugh traffic may induce due to burrowing constructing material site.
- Flora and Fauna may affect due to waste water discharge, weed control, and Site clearing, municipal solid waste discharge. Avifauna, Aquatic flora and fauna.
- Natural habitats may affect due to most of the activities.
- There can be health and safety issues due to tower crane, construction work construction material.

#### Positive Impacts

- Economic Development
- Increments of living standards of the residents
- Luxurious facilities for residents

#### CHAPTER 5 - PROPOSED MITIGATORY MEASURES



University of Moratuwa, Sri Lanka.  
Electronic Theses & Dissertations  
[www.lib.mrt.ac.lk](http://www.lib.mrt.ac.lk)

Following mitigatory measures are proposed for mitigate the impacts identified in the Leopold Matrix in impact identification chapter.

- Air Pollution – Transportation and storage of construction materials can potentially cause disturbance to the general public, increase dust and damage to minor roads. Transport, loading and unloading of construction materials should not cause nuisance to the people by way of noise, vibration and dust. All drivers should obtained license for the category of vehicles they drive and follow the speed limits of roads based on the traffic rules and regulations. Construction materials should not exceed the carrying capacity of trucks. Water sparing to roads and work surfaces will minimized the amount of dust in suspension in air. Use tire wash stations for vehicles entering and leaving the construction site. Relocate intakes to better-protected locations using plywood ‘hoarding’ or metal ducts. Add temporary pre-filters to increase life of air handling unit filters.
- Noise Pollution – Since this is a semi-urbanized area noise pollution can affect to the environment. Noise emanating from construction activities will be major impact. schedule

noise-intensive work for the least noise-sensitive time of the day. Increase the separation distance between noisy equipment and noise-sensitive locations. Install noise barriers around active areas to screen and protect noise sensitive areas. Mainly one side of the land area is free from the houses so it proposed to more concern on the side of the land where the houses were located. Relocate noise-sensitive building spaces to less-impacted locations. Review the construction plan to produce limits on noise emissions emitted by construction equipment. It is proposed, all vehicle engines to have working mufflers to minimize noise emanating from vehicle engines.

Regulations provided in the National Environmental (Noise Control) Regulation No. 1 of 1996, are applicable during construction (Schedule III). The maximum permissible Noise Levels at boundaries of the land in which the source of noise is located in  $L_{Aeq}, T$ , for construction activities are as follows:

Day time: 63 dB (A)

Night time: 55 dB (A)

Note:  $L_{Aeq}, T$  means the equivalent continuous, A-weighted sound pressure determined over a time interval  $T$  (in dB).

- Excessive Vibration & The Interim Standard on Vibration Pollution Control for Sri Lanka provides guidelines for operation of machinery, construction activities, vehicular movements, acceptable human exposure to vibrations depending on the length of the vibration period (continuous, intermittent, and impulsive). All motor-driven generators, compressors, pumps, etc., must be fitted with silencers.

The vibration from the heavy vehicles during transportation of material could induce vibrations which would sometimes exceed the above levels which will cause discomfort to persons living in the immediate vicinity. Damage to property due to vibrations induced due to the pile inserting and the geological investigation. Inconvenience for occupants in buildings is of concern; especially the site is located in a residential area (particularly during night-time) and offices (during day-time) along the transportation routes. As heavy vehicles create intermittent vibration the maximum allowable limit of ppv would be 1.59 mm/sec at 1 Hz, and 9.5 mm/sec.

One of the propose method is to construct the diaphragm wall within the most affected sides but this a high cost wasting measure it is other area within the land perimeter natural method can be implemented. As according to the references loose soil will absorb the vibration so

it better to dig a trench around the perimeter and sand layer is inserted within the trench which will absorb the vibration up to certain extent.

- Road Traffic - Material transportation during land development, and subsequent construction of houses would affect the traffic in the immediate area during construction. This increase in traffic would be short term and temporary. But the traffic generated due to the operation stage of the apartment building will be higher. In order to concern on this, Traffic Impact Assessment is separately carried out. In that it is proposed measures to reduce the impacts. For the further clarification TIA report can be referenced.
- High Waste Generation – Within the operational stage there will be high waste that generate. So it is proposed to separate (segregation) the daily collected municipal waste with the help of Kaduwela Municipal Council. Bio degradable waste can be dumped within site by implementing a compost unit.
- Minimize the surface and ground water pollution – There are 160 apartment within the building so there will be high waste water generation. In order to discharge the waste water it is proposed to introduce a waste water treatment plant and the part of the treated water will be taken use for the flushing activities and remaining will discharge in to the Kollonawa Lake.
- Minimize the accidents

The contractor party has to take necessary precautions to avoid the accidents within the site, by using Instructions and sign boards and safety meetings. Appoint safety officers with a crew to take care of the safety of the workers and the premises. Same time it is better to have a awarding programmes for the construction staff in order encourage them for concern on the their own safety.

## CHAPTER 6 – ENVIRONMENTAL MANAGEMENT PLAN

Environmental Management plan is proposed to ensure that the proposed project would not generate any negative impact on environment. Since it is identified, that some environmental elements are affected due to the more than one construction activities.

**Table 3.3 Environment Management Plan**

Environment Element	Description	Mitigation Measure
Air Quality	Air quality may affect due to the transportation of construction material. Since the total land area is around 180 perches, air pollution may cause to several illnesses with the surrounding community.	Materials stored should be covered or sprayed with water. Construction works must be stopped during strong wind. Place a tire wash stations for vehicles entering and leaving the construction site. Water will be sprayed on active construction roads and excavation sites twice a day Upon completion of civil works, all construction sites will be required to be re-vegetated with trees and grasses
Noise	Due to the vehicular transportation and the construction machinery may Leads to high noise generation to surrounding.	Schedule noise-intensive work for the least noise-sensitive time of the day. Try as much as possible to minimize the high noise emanating machines. Install noise barriers around highly vulnerable sides of the land





Vibration	Vibration is a major problem because there are several houses immediately near the boundary of land.	Construction of diaphragm walls within the highly vulnerable perimeter of the land to prevent excessive
Vehicular Traffic	This is illustrated clearly in the Traffic Impact Assessment Report	

**CHAPTER 7 - ENVIRONMENTAL MONITORING PROGRAMME**

Above mentioned Environment Monitoring Plan is monitored by day to day by the relevant consultants and also the client and there will be some visits from the Central Environment Authority to check whether that proposed measures are applied in to the project.

Monitoring Committee included following personals.

- A representative from the Project Approving Agency
- A representative from the Project Proponent
- A representative from client
- NGOs
- Politicians
- A representative from the community

**Table 3.4 Environmental Mangement Plan**

Potential Impacts and/or Issues	Parameters to be checked	Frequency to be checked	Mitigation Measures	Project Implementing Company	Supervising Agency
Excessive Vibration	Cracks appeared in the nearby houses	When There is a complain	Construction of diaphragm walls within the highly vulnerable perimeter of the	Contractor	Monitoring Committee

			<b>land to prevent excessive vibration</b>		
<b>Noise Pollution</b>	<b>Noise levels by the equipments</b>	<b>When There is a complain</b>	<p><b>Schedule noise-intensive work for the least noise-sensitive time of the day</b></p> <p><b>Try as much as possible to minimize the high noise emanating machines</b></p> <p><b>Install noise barriers around highly vulnerable sides of the land</b></p>	<p><b>Contractor</b></p> <p><b>Contractor</b></p> <p><b>Contractor</b></p>	<p><b>Monitoring Committee</b></p> <p><b>Monitoring Committee</b></p> <p><b>Monitoring Committee</b></p>
<b>Air Pollution</b>	<b>By observing the surfaces</b>	<b>When There is a complain</b>	<p><b>Materials stored should be covered or sprayed with water.</b></p> <p><b>Construction works must be stopped during strong wind</b></p>	<p><b>Contractor</b></p> <p><b>Contractor</b></p> <p><b>Contractor</b></p>	<p><b>Monitoring Committee</b></p> <p><b>Monitoring Committee</b></p> <p><b>Monitoring Committee</b></p>





University of Moratuwa, Sri Lanka.  
 Electronic Theses & Dissertations  
[www.lib.mrt.ac.lk](http://www.lib.mrt.ac.lk)

			<p><b>Place a tire wash stations for vehicles entering and leaving the construction site</b></p> <p><b>Water will be sprayed on active construction roads and excavation sites twice a day</b></p> <p><b>Upon completion of civil works, all construction sites will be required to be re-vegetated with trees and grasses.</b></p>		
<p><b>High Waste Generation</b></p>	<p><b>Visual Observing</b></p>	<p><b>When There is a complain</b></p>	<p><b>promote best practice waste management focusing on minimization,</b></p>	<p><b>Contractor</b></p>	<p><b>Monitoring Committee</b></p>



University of Moratuwa, Sri Lanka.  
 Electronic Theses & Dissertations  
 www.lib.mrt.ac.lk

			<p>reuse, and recycling</p> <p>Develop a proper solid waste management plan with the support of the Colombo municipal council (proper waste segregation and collection)</p>	Contractor	Monitoring Committee
<p>Minimize the surface and ground water pollution</p>	 <p>Water quality parameters BOD , COD , TSS</p>	<p>Once a month and when there is a complain</p>	<p>Introducing waste water treatment plant at the operation stage</p> <p>Construct suitable sanitary disposable system during construction stage waste disposal</p>	Contractor	Monitoring Committee

<p><b>Minimize the induced high traffic</b></p>	<p><b>By Traffic Counts</b></p>	<p><b>At the Operational Stage</b></p>	<p><b>All material burrowing can be done at night or minimize those operation at least during peak hours.</b></p> <p><b>All concreting works may plan to start at night to minimize road blocks</b></p>	<p><b>Contractor</b></p>	<p><b>Monitoring Committee</b></p>
<p><b>Minimize the accidents in the construction stage</b></p>	<p><b>Visual Observing during safety plan</b></p> 	<p><b>Within the whole project duration and safety meeting must be held every two weeks</b></p>	<p><b>Contractors will implement adequate precautions to protect the health and safety of construction workers</b></p> <p><b>At the construction stage organize safety meetings at least once a week</b></p>	<p><b>Contractor</b></p> <p><b>Contractor</b></p> <p><b>Contractor</b></p>	<p><b>Monitoring Committee</b></p> <p><b>Monitoring Committee</b></p> <p><b>Monitoring Committee</b></p>

			<p><b>Provide personal protection equipment, such as safety boots, helmets, gloves, protective clothing, goggles, and ear protection, in accordance with relevant health and safety regulations for workers</b></p>	<p><b>Contractor</b></p>	
		<p>University of Moratuwa, Sri Lanka. Electronic Theses &amp; Dissertations www.lib.mrt.ac.lk</p>	<p>An emergency response plan to take actions on accidents and emergencies will be prepared, including environmental and public health emergencies associated with hazardous material spills and similar events</p>	<p><b>Contractor</b></p>	
				<p><b>Contractor</b></p>	

			<p><b>Train all construction workers in basic sanitation, general health and safety matters, and on the specific hazards of their work.</b></p> <p><b>Appointing safety officers to deal with the safety matters</b></p>		
--	--	--	--	--	--

**CHAPTER 8 - CONCLUSION AND RECOMMENDATION**



University of Moratuwa, Sri Lanka.  
 Electronic Theses & Dissertations  
[www.lib.mrt.ac.lk](http://www.lib.mrt.ac.lk)

Since this is not a prescribed project with reference to the Environmental act no 47 of 1980 it is recommended to follow an Initial Environmental Examination and prepare a report based on that. All the essential chapters are included in the report and identified certain impacts to the environment due to the project. Although several impacts most of them are not critical or not leads major disasters so those identified impacts can be easily mitigated by simply measures all mitigatory measures are organized and proposed in a well manner. It is better to supervising the impact mitigation plan to encourage the people to work in an environment friendly way.

Modified Leopold Matrix

	PRECONSTRUCTIVE																OPERATIONAL STAGE																						
	Reconnaissance	Land Survey	Geological	Planning and	Land Acquis	Comphens	Developm	Site Clearin	Site office	locate the	sanitation	crane	Replacem	Constructi	Land Level	Excavation	Pile founda	B piles or	Soil filling	Compactio	cture	Brick work	Painting	Architectu	Elements	lating for	waste	electricity	Air	Parking	Generator	ng	Chemical	Solid	Contorl	y Fire			
A 1. a) Mineral Resources			1				1	1							1	1				1																			
b) Construction Material																												1											
c) Soil	1		2				1	2			2				1	1		1	1								1								1	1	2		
d) Land Forms (pa	1		2				2	1							1																								
e) Topograpy							2	1							1	1			1																				
2. a) Surface								1			2			1	1	1				1									2						1	2	2		
b) underground								1			2				1	1													2							1	2	2	
c) Quality								1			2			2	1	1													2							1	2	2	
d) Temperature														1																									
e) Quantity																																							
e) Recharge																																							
3. a) Quality																												1		2	1	2					1	2	
b) Climate																																							
c) Temperature																																							
4. a) Floods																																							
b) Erosions																1																							
c) Deposition																																							
d) Settlements																																							
e) Soil Stability			1					1									1		1																				
f) Noise			2										2	2		1		2								1													
g) Vibartion			2										2													1													
h) Road Traffic		1																																					
B 1. a) Trees			1				2	2		1					1																						1	1	1
b) Shrubs		2	2	1			2	2		1					1	1						1														1	1	1	
c) Grass		2	2	1			2	2		1					1	1																				1	1	1	
d) Crops															1																					1	1	1	
e) Aquqtic Plants								1																				2								1	1	1	
f) Endangered Sp	1	1	1				2	2		1					1	1																			1	1	1	1	
2. a) Birds (Avifauna)	1	1	2				2	2		1					2	1			1		1	1												2	1	1	2	1	



University of Moratuwa, Sri Lanka.  
Electronic Theses & Dissertations  
www.lib.mrt.ac.lk



	b) Land animals in	1	1	2				2	2	1				2	1		1	1	1	1						1	1	2	1	
	c) Fish							1										1	1			2					1	2	1	
	d) Insects							1	2	1																1	1	2	1	
	e) Endangered Sp	1	1	2				2	2	1				2	1		1	1	1								1	2	1	
	f) Migratory Avifa	1	1	2				2	2	1				2	1		1	1	1							2	1	1	2	1
C.)	a) Eutrophication																					1					1	2		
	b) Food Chains								2														1				1	1		
	c) Natural Habitat	2	2					2	2					2	1		1	1	1			1			1		1	2	1	
	d) Eco Systems							2	2					1		1	1	1				1					1	2	1	
D.1)	a) Wilderness and Open Space							2	2																					
	b) Wetlands																					1						2		
	c) Agriculture																													
	d) Residential							1																						
	e) Commercial							1																						
	f) Industry							1																						
2.)	a) Fishing																					1					1			
	b) Boating																													
3.)	a) Scenic views and vistas																													
	b) Landscape Design																													
	c) Parks																													
4.)	a) Cultural Patterns																													
	b) Health and Safety																										1		1	
	c) Employment																													
	d) Population Density																													
	e) Social Harmony																													
E.)	a) Infrastructure																													
	b) Income Level																													



University of Moratuwa, Sri Lanka.  
 Electronic Theses & Dissertations  
[www.lib.mrt.ac.lk](http://www.lib.mrt.ac.lk)

Lower Negative	1	Yellow
Medium Negative	2	Orange
Severe Negative	3	Red
Positive Impacts	1	Blue

## 4. TRAFFIC IMPACT ASSESEMENT

### 1. INTRODUCTION

The luxury apartment complex proposed will create considerable amount of traffic. The positive and the negative impacts are looked through the traffic impact assessment and suitable negative impact mitigation measures are proposed at the end. We will look at the construction phase and operating phase impacts.

The main objectives of this study are,

- To get a clear understanding about existing traffic conditions around the site
- To estimate the potential traffic generation due to the proposed development
- To assess parking requirements and circulation inside the building and around the site.
- Identify possible transportation and related issues due to the proposed development.



University of Moratuwa, Sri Lanka.  
Electronic Theses & Dissertations  
[www.lib.mrt.ac.lk](http://www.lib.mrt.ac.lk)

This report consists of evaluation of the parking arrangement, circulation inside the building and traffic management measures that are required to handle the existing traffic as well as the forecasted future traffic of the area.

### 2. EXISTING CONDITIONS

#### 2.1. SITE LOCATION

The proposed apartment is to be constructed in Rajagiriya. Minor road (Perera Mawatha) is located in front of the site. This road is connected to Buthgamuwa road. Perera mawatha is primarily used by the residents of adjacent apartment complexes such as Fair mount residencies and Sky garden. Some of offices are also nearby the area. Kolonnawa canal is in front of the site running adjacent to the perera mawatha. The site is connected to the perera mawatha in its southern part by a private road. This

private road is going around the site to the western side of the site. The private road is used by several residents near by the building.



**2.2. ROAD NETWORK**



University of Moratuwa, Sri Lanka.  
Electronic Theses & Dissertations  
www.lib.mrt.ac.lk

There is one main access route (Perera mawatha) to the site from Buthgamuwa road (B469). Fair mount residencies and sky garden residencies are also in this route away from the Buthgamuwa road. This site is much closer to the Buthgamuwa road.

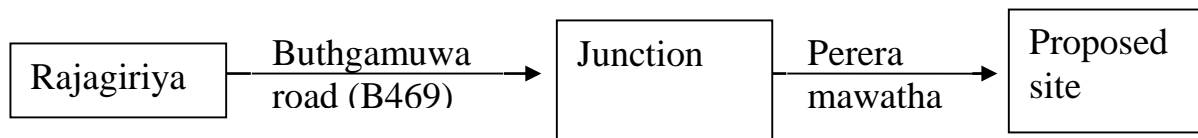

Buthgamuwa road



Pereramawatha

**Figure 2.2:** Adjacent road to the site

### 2.3. LAND USE

Land area around the site can be considered as a residential area. The surrounding area is highly concentrated with apartments such as fair mount residencies and sky garden.



**Figure 2.3:** Land use around the sit

### 2.4 TRAFFIC FLOWS

To determine the existing and future traffic condition it is necessary to obtain existing traffic data of the road network. In our project we need traffic data of Buthgamuwa road and the Perera mawatha.

Traffic counts were conducted during the first week of November 2014, in order to identify the present traffic condition around the site. Manual traffic counts were done on Buthgamuwa road near the Perera mawatha and Perera mawatha. Traffic count was taken considering both directions from 6:30 a.m - 8 : 30 a.m. Buthgamuwa road and perera mawatha are two lane roads. High traffic can be seen in Buthgamuwa road in school hours. According our traffic count we can see the peak hour is for Buthgamuwa road and Perera mawatha is 7.00 a.m. – 8.00 a.m.

Details of the traffic surveys are given in Annexure.

#### 2.4.1 On Buthgamuwa road

Traffic flow in the peak hour is  $= (693 + 634 + 768 + 634)$   
 $= 2729$

The day time 12 hour traffic flow  $= 2729 + 2729 * 0.8 * 11$

$$= 26744$$

Assuming vehicle growth rate is 1.25 %

$$\text{Traffic flow in the next 10 years} = 26744 * (1+0.0125)^{10}$$

$$= 30280$$

The day time 12 hour traffic flow is about 26744 vehicles in Buthgamuwa road. And that traffic mainly consists of light vehicles. Therefore assuming 1.25% vehicle growth rate, in the next 10 years this road would be carrying nearly total of 30280 vehicles per day.

Majority of the vehicles on Buthgamuwa Road is motor cycle (30%). Same amount of cars are also exist. It is followed by three wheel (22%) and utility type vehicles whose contribution is 16% of van and 5% from other each category. Since there is one bus route operate in the Buthgamuwa road, contribution from buses are low than other categories. It is 2% of the total vehicle amount is large busses small buses. Certain amounts of goods vehicles are also available in this road segment. Presenting according to the category, 2% of good vehicles and 1% of others (tractors, bicycle.) are available on this road segment. When we were taken the traffic count there are some construction going on. Therefore no of goods vehicle were high. But after 10 years it may be changed. Refer Annex 1

## 2.4.2 On Perera mawatha

$$\text{Traffic flow in the peak hour is} = (30 + 29 + 30 + 27)$$

$$= 116$$

$$\text{The day time 12 hour traffic flow} = 116 + 116 * 0.5 * 11$$

$$= 754$$

Assuming vehicle growth rate is 1.25 %

$$\text{Traffic flow in the next 10 years} = 754 * (1+0.0125)^{10}$$

$$= 854$$

Majority of the vehicles on Buthgamuwa Road is car (52%). Other than the cars can be seen van , motor cycle , three wheel , goods vehicles. Refer Annex 1

## 2.5 NEED OF TIA

### 2.5.1 Buthgamuwa road

Accordinging traffic count that we done during the day time (12 hour from 6.30 a.m. to 6.30 p.m.) Buthgamuwa road carries around total of 26744 vehicles per day (vpd) two ways.

Assuming 1.25% vehicle growth rate, in the next 10 years this road would be carried nearly total of 30280 vehicles per day two ways.

After the ten years no of traffic will generate due to proposed site will be 640. (Annexure)

The traffic to and from the development not exceed 10% of the two way traffic flow ( 2%) on the Buthgamuwa road. Because of that don't want to increase the width of the Buthgamuwa road.

According to TIA-569 Pathways & Spaces Standard,

the traffic to and from the development exceed 10% of the two way traffic flow on the main highway/road	Not warranted
the traffic to and from the development exceed 5% of the two way traffic flow on the adjoining road/link where traffic congestion exists or will exist within the assessment period or other sensitive locations	Not warranted
Residential development in excess of the 20 unit in the concentrated development zone and mixed commercial zone Residential development in excess of the 50 units outside of the above zones	Not warranted
Commercial floor area in excess of 10000 sq.ft.	Not warranted
Warehousing floor area in excess of 20000 sq.ft.	Not warranted
Retail shop floor area in excess of 5000 sq.ft.	Not warranted
100 trips in/out combined in peak hours	TIA warranted
50 onsite parking space	268 parking spaces required. TIA warranted
Any development having entry or exit direct onto a road which is	
A National high way or	Not warranted
within 15 meters of a bus halt or bus stand or	Not warranted
within 25 meter of a pedestrian crossing	Not warranted

**Table 2.1** Need for TIA

## 2.5.2 Perera mawatha

According traffic count that we done during the day time (12 hour from 6.30 a.m. to 6.30 p.m.) Perera mawatha carries around total of 754 vehicles per day (vpd) two ways.

Assuming 1.25% vehicle growth rate, in the next 10 years this road would be carried nearly total of 854 vehicles per day two ways.

After the ten years no of traffic will generate due to proposed site will be 640. (Annexure)

The total traffic due to the development exceed 10% of the two way traffic flow (75 %) on the Perera mawatha. Because of that want to increase the width of the Perera mawatha.



University of Moratuwa, Sri Lanka.  
Electronic Theses & Dissertations  
[www.lib.mrt.ac.lk](http://www.lib.mrt.ac.lk)

## 2.6 IDENTIFIED POTENTIAL IMPACTS

The traffic impacts from the proposed development can be identified in two stages.

- (1) During construction stage.
- (2) Future problems.

### 2.6.1 Problems identified during construction stage.

#### 2.6.1.1 Damage the pavement due to heavy vehicle traffic

The main access road is Perera mawatha it is a low traffic road which has lower pavement strength and the pavement has not designed to accommodate heavy material transportation vehicles. It can be anticipated that higher number of vehicles will access the proposed site by using the access road to unload the construction materials and goods which are necessary for the construction works. Therefore the road surface would be immediately damaged.

#### 2.6.1.2 Traffic Congestion due to the heavy vehicle traffic

The level of service of the existing road ( Buthgamuwa road and Perera mawatha) and the road condition is not capable to handle higher vehicle traffic. We can see there is a bridge near the junction it is very narrow, it cannot facilitate smooth two directional traffic flows in Buthgamuwa road. And also Perera mawatha is very narrow ( average width is 7 m).Therefore heavy vehicles generate the traffic create congestion on the Buthgamuwa road and Perera mawatha.

### 2.6.2 Due to the future traffic flow

#### 2.6.2.1 Increased congestion

Proposed development consist 160 apartments. Therefore heavy number of traffic will generate due to proposed development. In the future generate traffic will not affect the traffic of Buthgamuwa road. But it will affect to the Perera mawatha.

#### 2.6.2.2 Damage the road pavement

Existing road pavement of the perera mawatha is not designed to carry higher vehicle load and therefore it will be damaged immediately.

#### 2.6.2.3 Safety Issues

There are many safety issues can be identified on this road during functioning time. There are

- No sign boards
- No pedestrian crossings



- Narrow road with a bridge
- No lane markings
- No proper parking spaces
- No proper bus halts

## 2.7 Mitigation measures

The basic idea of the traffic impact assessment is to develop mitigation measures to the identified impacts from the TIA. In our project we have proposed the mitigation measures given below minimize the impacts and increase the safety of the road.

- Improve the road geometry by road widening  
Specially in the Perera mawatha , the existing pavement does not have the capacity to accommodate the heavy traffic conditions. Therefore the road geometry will be redesign changing the road to a 2 way road with the other relevant facilities.
- Improve the bearing capacity of the road and rehabilitate the road before the commencement of the building construction.  
Buttgamuwa road is significantly high traffic road which is single bituminous road. It should be rehabilitating to an asphalt concrete road to accommodate huge traffic conditions.
- Make the lane according to the regulation and standards  
The clear regulations and guidelines of constructing roads will be used for the road design.
- Establish the sign polls in relevant places  
As the roads are narrow , it is required to provide the relevant sign polls and guiding texts in the necessary places of the access road as well as the interior roads to maximize the safety of the road.
- Proper junction design  
A proper junction design should be done for the junctions located along the access road to mitigate the congestion and increase the mobility.
- Allocate spaces for lateral clearance in bends  
It is required to provide lateral clearance for the bends in the road for safety.
- Avoid visual intrusion and disturbances  
Visual intrusion and sight disturbances will be eliminated as much as possible to increase the safety condition of the road.

- Proper designing of the road drainage system  
A well functioning drainage system is required for the safety of the road as well as the durability of the road. Therefore road side drainages will be provided adequately. But in our project when we consider the Perera mawatha it is very hard to provide space for drainage system. Because kolonnawa canal is near the Perera mawatha.
- Establish the rails at the road sides where it necessary  
Side rails will be provided beside the roads where the boundary of the road heading to a bends and steep slopes which create danger conditions for the traffic.
- Provide separate pedestrian walkways  
Pedestrian walkways will be provided for the comfort of the pedestrians and for the safety of them. Most of the villagers do not have their own private vehicles and therefore it is required to provide the necessary facilities for pedestrians.
- Decide speed limits for the road  
The speeds limits will be declared for the access road and interior roads to increase the safety of it.
- Provide separate turning circles in parking areas
- Establish adequate lighting facilities
- The lightning facilities for the access road and the interior roads will be provided to ensure the visibility during night time and to increase the safety of the roads.

## 2.8 PRESENT TRAFFIC MANAGEMENT

Buthgamuwa road and perera mawatha are two lane 2 way highways. Average lane width of the Buthgamuwa road is 4 m and average lane width of the perera mawatha is 3.5 m. The proposed site is situated about 75 m away from Buthgamuwa road perera mawatha junction. Access for the land is provided from perera mawatha. It is a T junction which connects perera mawatha and Buthgamuwa road. There is no traffic control mechanism at the junction. There is no lane marking on Buthgamuwa road or Perera mawatha. There is no road signs on Perera mawatha and no proper road signs on Buthgamuwa road.

## 2.9 PUBLIC TRANSPORT

There are no buses in the minor road, but when considering the Buthgamuwa road, there are several buses representing several bus routes are in operation. Apart from short distance bus routes such as Kelaniya / seemamalakaya (150), Kollupitiya/Kohilawaththa (175), which are passing through the land, There is one bus halt, it is located at the junction which connects perera mawatha and Buthgamuwa road.

## 2.10 PARKING

In any building project, parking arrangement, parking space and access to the parking must be carefully decided. For a High-rise Building which totally function as a Residential Building the parking spaces depend on many reasons.

- No of Apartments of the building
- No of bedrooms per apartment or no of residents in a house
- Type of the apartment (Luxury, Semi-luxury or budget)
- Other facilities which are open to the outsiders (Bar, Club, Supermarket, Pool, etc...)



University of Moratuwa, Sri Lanka.  
Electronic Theses & Dissertations  
www.lib.mrt.ac.lk

In our building, we have decided to have our car park in the same building by reserving some ground floors for the car parks. But for the convenience of analyzing, for the effective use of space and for maximize the capacity of the car park in a single floor, we had to have a bigger floor area for the car park with 51m\*35m in dimension. Therefore we had to provide 5 stories for parking.

### 2.10.1 Determination of Parking Arrangement System

#### 2.10.1.1 Number of Parking Stalls

No of units per floor	4
No of stories in the building	40
No of total units in the building	160
Assume 1/3 of luxury houses are given permanent 2 lots for parking	106
1/10 have paid for additional 1 lot	32
Rest have single parking	92

Total parking for residents	230
Visitors/Special Occasions	18
Services/ Maintenance vehicles	5
Total car parking requirement	253

Provided the 41 parking lots in Ground floor , 50 parking lots in first floor and other three floors have 54 parking spaces.

#### 2.10.1.2 Dimensions of parking stalls

Standard 2.4 m x 4.8 m (But we provided 2.4 m x 5 m)

For disables 2.4 m x 6.2 m ( We provided 8 lots for disables)

#### 2.10.1.3 Minimum width of aisle

Since 90 degrees parking is used a minimum width of 7.3 m aisle should be used. (Minimum width required for 45 degrees and 60 degrees angle parking is 4.8 m)

#### 2.10.1.4 Width of access to parking areas

Entry and exit are provided together rather than providing entry and exit separately.

Therefore a minimum entry/exit width of 7.2 m is used.

#### 2.10.1.5 Turning radius

Turning radius is 7.3 m.

#### 2.10.1.6 Margin lane

As minimum turning radius required for commercial vehicles of 7.3 m is provided.

#### 2.10.1.7 Ramp gradient

A minimum ramp gradient of 1: 8 is provided for the ramp in the parking area.

#### 2.10.1.8 Width of the ramp

A minimum width of 7.3 m which is same as the access road to the parking area.

#### **2.10.1.9 Clear height on Ramps**

A minimum clearance height of 1.6 m is provided for the parking areas at the basement.

#### **2.10.1.10 Security and parking control**

Security checking is done at the main gate and assistance sign boards are provided in the parking stalls for guiding the vehicle owners hence the control is automatically established.

#### **2.10.1.11 Vehicle weighing areas**

Since there is no requirement of measuring the weights of the vehicles, this section is not applicable for this building.

#### **2.10.1.12 Sloping Floors**

All parking slots provided are flat terrains hence not relevant.

#### **2.10.1.13 Narrow road frontage**

This section is not applicable with the proposed development



University of Moratuwa, Sri Lanka.  
Electronic Theses & Dissertations  
[www.lib.mrt.ac.lk](http://www.lib.mrt.ac.lk)

#### **2.10.1.14 Traffic control improvements**

The congestion can be expected during the festival times and holidays. Since it has been provided adequate parking slots outside the building, it will be able to accommodate the sudden demand and the access road sides can be used for parking if any requirement arises.

#### **2.10.1.15 Inspection of parking**

The relevant authorities will be allowed to inspect the parking arrangement and the traffic control system of the proposed development

#### **2.10.1.16 Vehicle Restricted Area**

No vehicle restricted areas have been defined inside the parking slots.

**4.5.1.7 Turning Radius**

As a considerable number of commercial vehicles are expected to enter the site a minimum inner turning radius of 12.8 m and a minimum outer turning radius of 8.7 m is to be used. <i>Table 4-4 Turning Radius Passenger car</i>		<b>Two axle commercial vehicles</b>
<b>Inner turning vehicles(m)</b>	7.3	12.8
<b>Outer turning radius(m)</b>	4.7	8.7



University of Moratuwa, Sri Lanka.  
Electronic Theses & Dissertations  
[www.lib.mrt.ac.lk](http://www.lib.mrt.ac.lk)

## 5. ARCHITECTURAL CONCEPT

Building architecture is not only about performing of its aesthetic appearance but also it's about use of limited space in effective manner. As a luxury apartment building architectural concept plays major role in the project. In the feasibility stage several alternatives for building purposes were analysed and finally apartment building concept is identified as the best option for the investment. In the preliminary design first we select the shape of the building and its orientation. Then according to the functionality its spaces were allocated. In here area for houses is the primary requirement. Apart from that parking area for vehicle and common areas for recreational and social activities and gardens are considered in architectural conceptual design.

### 5.1. Building Architecture

#### 5.1.1. Shape and Orientation of the Building

First we came up with several alternatives for shape of the building. Out of those alternatives the most architecturally, economically and structurally feasible design has been chosen. Basically it is a rectangular shape in first five floors and rest of the floors are square shape.

Some of the important fact which we considered while designing the shape of the building are,

- Available land area (180purch)
- Orientation of the plot.
- Shape of the plot
- Number of apartment units needed (160 units)
- Required floor area per apartment
- Required service area
- Building regulations relevant to this location
- Height of the building
- Nature of the land
- Aesthetic appearance
- Road network around the plot.
- Nature of the surround such as houses, canals and..etc.
- Geological features in and around the proposed land
- Constructability..et

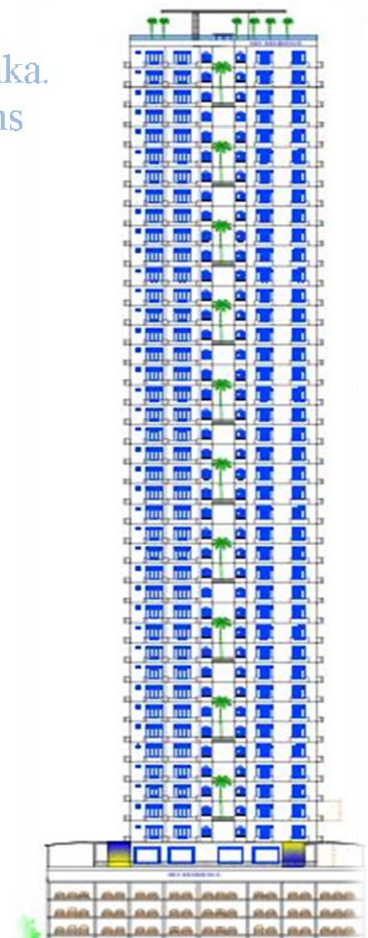

**Figure 5.1 Shape of the Building**

## 5.2. Planning of Activity Space of the Building

In the building, mainly three major areas can be identified according to its functionality. Those are apartment floors, parking floors and recreational areas (sixth floor and roof top garden).

### 5.2.1. Parking Area

First five floors of the building is allocated for providing parking facilities for users. Mainly it is a 51m x 38 m rectangular shape structure. The floor to floor height at parking floors is 3.2m but each floor has placed with 1.6m level difference in design. Because of that, space required to vertically circulate within the parking floors can reduce and increase the number of parking slots. Total floor area allocate for parking including access paths is around 9100 m<sup>2</sup> .it can safely park 260 vehicles.

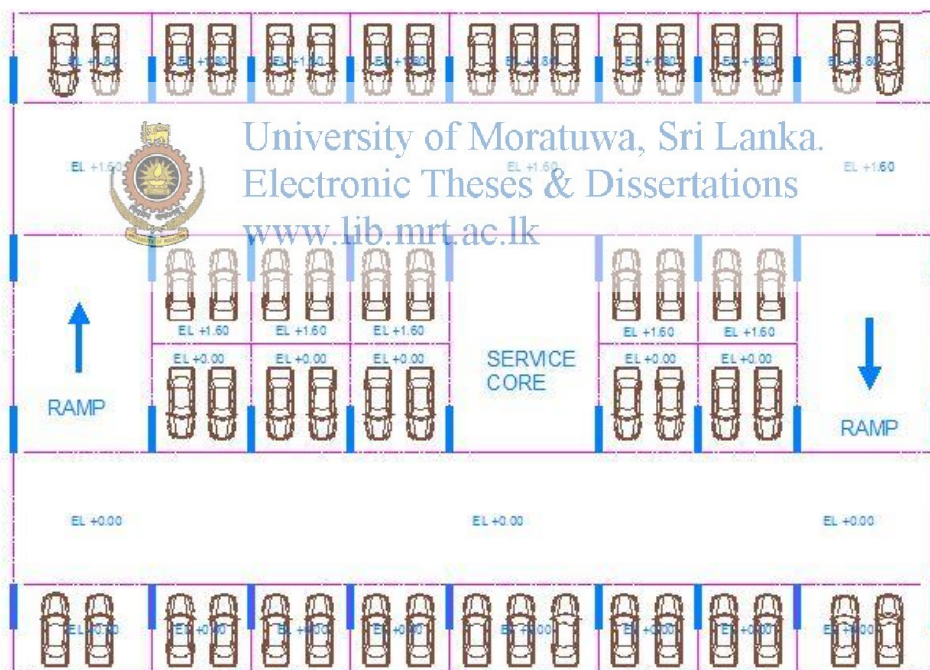

**Figure 5.2 Plan view of the typical parking floor**

While designing the parking arrangement ease of accessibility, safety and protection maximum utility of the space, appearance are mainly concerned. Mainly these floors are consist with concrete walls, columns and beam. Those structural element surfaces is to be finished as fair finish surfaces. Whole building in parking floors are designed to covered with steel-fiber mesh for safety. With the same time it can be used to grow some creeps on it to increases the aesthetic appearance and thermal comfort within the building.





Figure 5.3 Plan view of the typical parking floor

University of Moratuwa, Sri Lanka.  
Electronic Theses & Dissertations  
www.tb.mrt.ac.lk

### 5.2.2. Recreational Area

Sixth floor and part of the roof top are allocated for the recreational purposes of users. In this part of the building aesthetic appearance is highly concerned. This floor consists of the following features.

- Two swimming pools (each having 1.2m depth and 180m<sup>2</sup>)
- Small gardens with trees
- Restaurants (only for building users)
- Gym
- Kids playing area
- Washrooms
- Relaxing Benches



Figure 5.4 Recreational Area

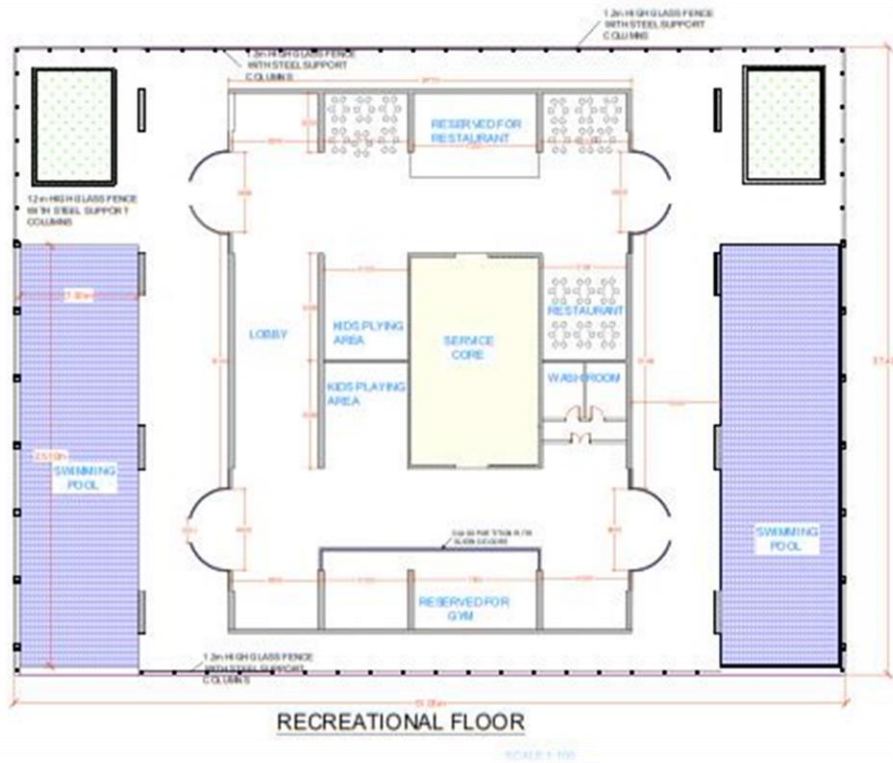

Figure 5.5 Plan view of recreational floor

University of Moratuwa, Sri Lanka.  
 Electronic Theses & Dissertations  
 www.lib.mrt.ac.lk

5.2.3. Apartments

Apartments are the main part of this high-rise building because it is the main purpose of the building and all the other parts are being as supporting features for that. There are 40 apartment floors and each having four apartments. These apartments are adopt with many sustainable features. There are two types of apartments as type 1 and type 2.

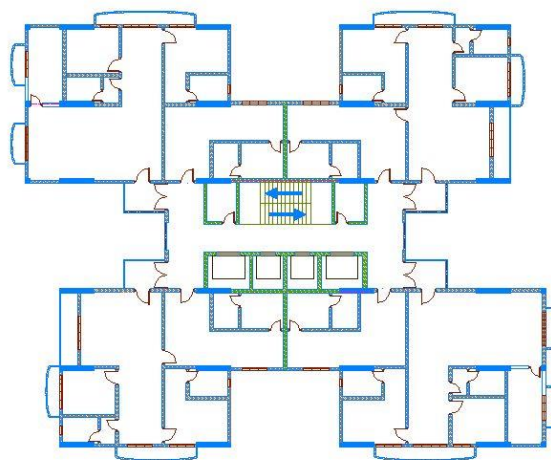

Figure 5.6 Typical apartment floor layout

While designing the internal arrangement of the apartment followings are mainly considered.

- Expected number of occupants
- Facilities required
- Maximum use of space
- Privacy of the users
- Safety and protection of the users
- Building regulations
- Aesthetic appearance
- Easy accessibility
- Less complexity
- Maximum natural light gaining
- Thermal comfort and ventilation
- Visual comfort
- etc...

Apart from those basic concerns, other important features provided in the apartment,

- Entrance lobby has been provided to the main entrance of the house.
  - ✓ To prevent others to see in side of the apartment
  - ✓ Provide space to visitors who do not wish to enter the inside
  - ✓ Put shoe racks and other stuffs
- Long open space has provided to enhance the visual comfort
- Apply bright White colour for internal walls
  - ✓ To provide the bigger image than actual.
- Living and Dining areas has not separated
- Kitchen has direct access to the Living and Dining
- In addition to the main entrance separate access has provided to the kitchen from the outside.
  - ✓ Things like garbage and foods need not to take across the living room.
- Attached bathroom has provide for master bed room and common bath room has provided for the other bed rooms and visitors
- Bed rooms has placed as not to directly see the inside of the bed rooms
- For the main lobby, passive lighting has been provided
- For each room balconies has been separated

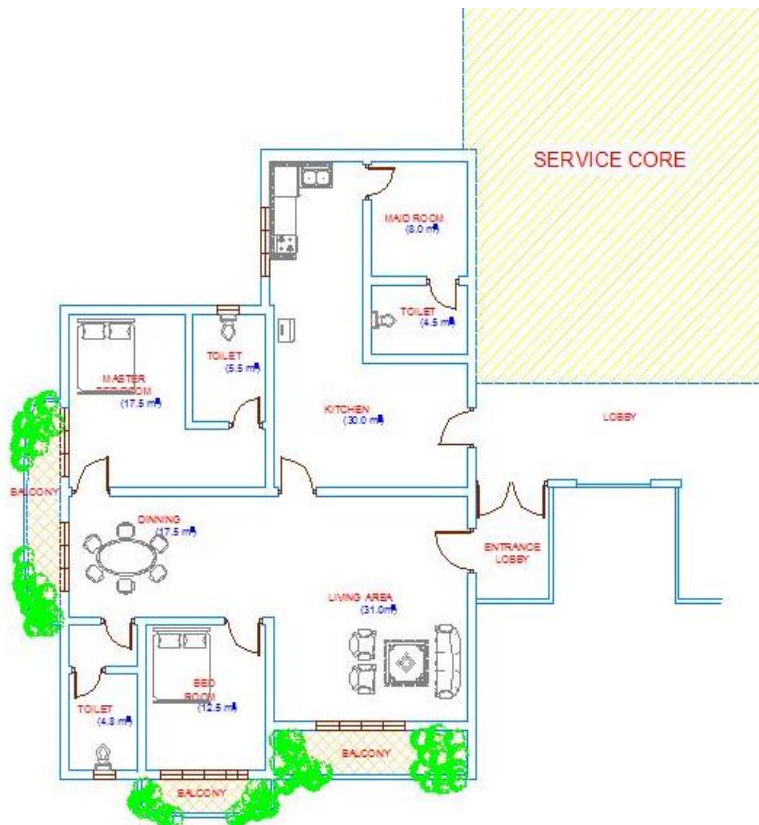

**Figure 5.7 Aptmnet Type 1**  
 University of Moratuwa, Sri Lanka.  
 Electronic Theses & Dissertations  
[www.lib.mrt.ac.lk](http://www.lib.mrt.ac.lk)

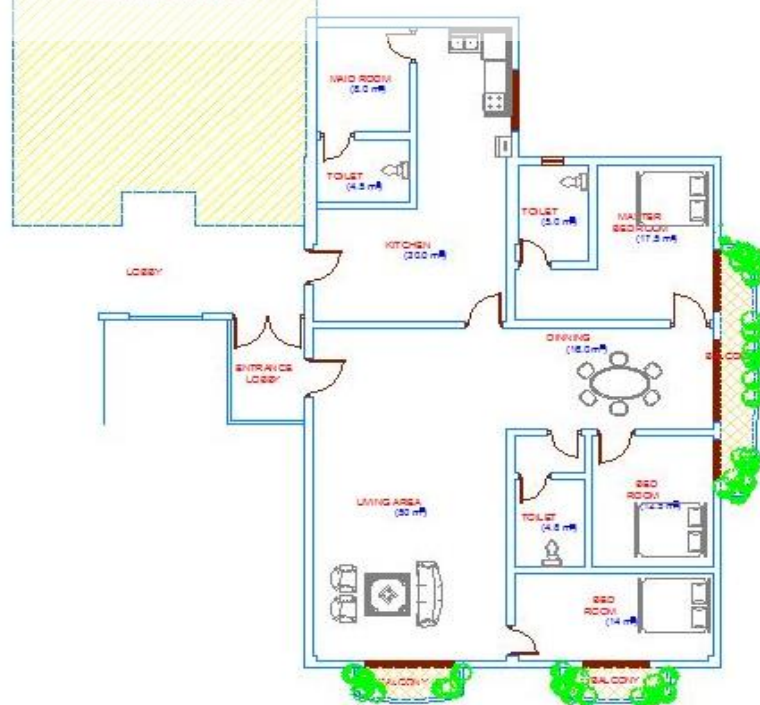

**Figure 5.8 Aptmnet Type 2**

**Table 5.1 Features and space allocation within the apartment**

Space	Average Area (m <sup>2</sup> )	
	Type 1	Type 2
<b>Total floor area</b>	200	170
<b>Living area</b>	50	32
<b>Dining</b>	16	17.5
<b>Master bed room</b>	17.5	17.5
<b>Other bed rooms</b>	12.5 & 14	12.5
<b>Kitchen &amp; pantry</b>	30	30
<b>Bath rooms</b>	5	5
<b>Powder room</b>	2	2
<b>Maid room</b>	8	8
<b>Entrance lobby</b>	6	6
<b>Balcony</b>	10.5	14

## Door and Window Arrangement

For all the internal door are timer paneled and which doors and windows expose to outside are sliding glazed windows with aluminum frames.

Table 5.2 Features and space allocation within the apartment

Type No`	Size	Position	Description
D1	6' 0" * 8' 0"	Main Entrance and Balcony Doors	Timber Panel Door with Wooden slates on top
D2	3' 0" * 8' 0"	Bed Room Entrance Doors	Plywood door with timber frame with timber slates on top
D3	2' 4" * 8' 0"	Bath Room Entrance Doors	Plywood door with timber frame with timber slates on top
D4	3' 4" * 8' 0"	Staircase Entrance Doors	Plywood door
W1	3' 4" * 5' 0"	Bed Room and Kitchen Windows	Sliding, Glazed Window with Aluminum frames.
W2	4' 0" * 8' 0"	Living Room Window	Sliding, Glazed Window with Aluminum frames.
W3	1' 8" * 2' 8"	Bath room Window	Glazed Fanlight with Aluminum frame and slates on top.

## 5.3. Landscaping

A sustainable landscape is designed to be both attractive and in balance with the environment and it should require minimal resource inputs. Thus, the design must be “functional, cost-efficient, visually pleasing, environmentally friendly and maintainable. As part of the concept called sustainable development it pays close attention to the preservation of limited and costly resources, reducing waste and preventing air, water and soil pollution. Landscape Maintenance practices greatly influence the waste produced and the cost of the maintenance itself.

### 5.3.1. Landscape Design Requirements

- Each and every space should have an aesthetically pleasing view.
- Space should be utilized as much as possible.
- The internal spaces must be able to easily interact with gardens and outside areas.
- The development should be incorporated as many green features as possible.
- Passive features should be incorporated with the design and construction.
- The entire development area should possess a classic and nurturing feel at the end of construction.



University of Moratuwa, Sri Lanka.  
Electronic Theses & Dissertations  
[www.lib.mrt.ac.lk](http://www.lib.mrt.ac.lk)

### 5.3.2. Main features suggested in landscape design.

Main basic features suggested in the landscape design are as follows,

#### Recreational area

- Children park
- Seat Walls
- Tables



**Figure 5.9 Landscape**

#### Main entrance and the road

- Main entrance consists of block paved Road
- Green Shrubs grow with in the two sides of the road

#### Walkways

- Earth block paved walkways are used.



**Figure 5.10 Landscape2**

**Gardening area**

- Arbor
- Decorative containers
- Fences
- Turf and ledge stones
- Garden lights
- Tree swins
- Water ponds and water fountains

Parking facilities for the large vehicles

Rain water harvesting system



**Figure 5.11 Landscape3**



**Figure 5.12 Landscape 4**

Further details suggested on landscaping is discussed under the section 'Sustainable Concept' (Section 10.)



University of Moratuwa, Sri Lanka.  
Electronic Theses & Dissertations  
[www.lib.mrt.ac.lk](http://www.lib.mrt.ac.lk)

## 6. DESIGN OF SERVICES

### 6.1. DESIGN OF LIFT ARRANGEMENT

#### 6.1.1. Introduction

The building consists of five storeys, so zoning is not required for this convention centre. Passenger lifts are designed and in addition to that one lift systems is introduced for requirement of services.

#### 6.1.2. Calculating the passenger lift requirement

Assumptions:

All apartments belong to prestige level.

A passenger handled in 5 minutes is 5%.

Number of 2 bedroom apartments per floor =2

Number of 3 bedroom apartments per floor =2

Number of bedrooms per floor = $3 \times 2 + 2 \times 2 = 10$

Expected number of occupants per floor = $10 \times 1.5 = 15$

Total occupants in the building = $15 \times 40 = 600$

Passengers handled in 5 minutes = $600 \times 5\% = 30$

ZONE 1-(LEVEL 6- LEVEL 30)

There are 25 apartment floors. Consider access to all 5 floors.

Expected passengers handled in 5 minutes = $30 \times 25 / 40 = 19$

Required interval between cars			
Car size	8 capacity	12 capacity	28 capacity
Time (s)	70	85	110

Round trip time for 30 floors (12 capacity car) =140 s

Interval between cars (with 2, 12 capacity cars) = $140 / 2 = 70$ s

70 s is in the acceptable range (50s-70s) & below required interval of 85 s.

*Hence 2 lifts of 12 car capacity are adequate for the zone 1.*

ZONE 2-(LEVEL 31-LEVEL 45)

There are 15 apartment floors. If access is given to all parking floors number of express floors is 25.

Travel time for 25 express floors = $25 \times 3.6 \times 2 / 4 = 45$ s

Number of people handled in 5 minutes = $30 - 19 = 11$

Required interval between cars			
Car size	8 capacity	12 capacity	28 capacity
Time (s)	75	95	120



Round trip time for 20 floors (12 capacity car) =115s

Round trip time for all floors =115+45 =160s

If 2 lifts are adopted, Interval between cars =160/2 =80s

80 s is above prestige range.

But number of people handled in 5 minutes is 11. There are 2 lifts as well. Each of the 2 lifts will carry less than 6 passengers given the round trip time of the lift is less than 5 minutes. This means each of the 2 lifts will not be carrying more than 8 passengers. Hence both lifts can be considered as 8 capacity cars.

Hence, Actual Round trip time (equivalent to 8 capacity car) =95+45 =140 s

If 2 lifts are adopted, interval between cars =140/2 = 70 s

This is within the allowable range for prestige apartments (50-70s) and below required interval. (75s)

*Hence 2 lifts of 12 capacity lifts are adequate for the zone 2.*

*Larger lift will be required for each zone to give space to carry larger home appliances such as sofas.*

*Hence one lift in each zone will be increased to a 28 capacity lift.*

*Conclusion:*

*Zone 1-Level 6 to Level 30- 1 lift of 12 capacities & 1 lift of 28 capacity*

*Zone 2-Level 31 to Level 45-1 lift of 12 capacities & 1 lift of 28 capacity*



University of Moratuwa, Sri Lanka.  
Electronic Theses & Dissertations  
www.lib.mrt.ac.lk

## 6.2. ARRANGEMENT OF THE STAIR CASE

### 6.2.1. Introduction

When designing a staircase, it is important to consider the proportion of tread to riser as comfortable level.

### 6.2.2. Calculating the dimension of the stair case

Referred document for the calculation is British standards code of practice CP 3, Engineering and utility services.

If the tread is T and the rise is R,

$$T + 2R = 25(\text{inch})$$

$$T + 2 \times 6 = 25$$

$$T_{\text{max}} = 13 \text{ inch}$$

$$T_{\text{max}} = 325\text{mm}$$

So, 300mm is selected as the tread.

Very flat stairs or steep ramps (in the range of 6 to 250) are less convenient and more dangerous than the preferred angles.

Width = 1.5m

Riser = 150mm

Tread = 300mm

Height of hand rails = 1m

**Figure 6.1 Stair Case**

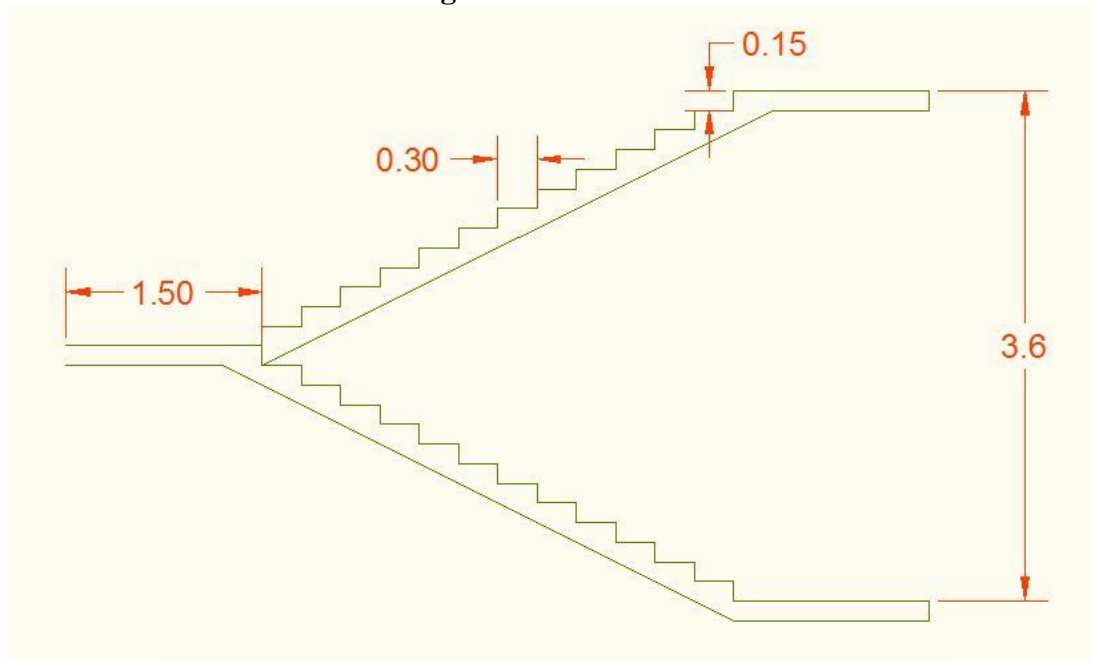

### 6.3. WATER SUPPLY SYSTEM

#### 6.3.1. Introduction

Water supply will consist of one overhead tank and water sump at the ground floor level each of having a water demand for one day thus we have water storage for 2 days. Water will be pumped to the overhead tank from the water sump. Distribution of water to apartments will be done using 2 vertical pipelines from the overhead tank each serving one 3 bed room apartment and one 2 bed room apartment at each floor. Water will be distributed through pressure reducing valves to avoid extreme pressures at lower floors and for upper floors there are standby pumps to pump water in a higher pressure if needed. (Annex 6.1)

Water for all the sanitary and kitchen appliances will be provided using clean water. A separate pipe containing recycled water from the water treatment plant will be running through to supply water for toilet flushing.

#### 6.3.2. Storage requirement

No. Of people in the building = 600

Per capita demand = 180 litres per day

Storage requirement =  $600 \times 180 = 108 \text{ m}^3$

For fire fighting =  $108/3 = 36 \text{ m}^3$

Storage to be provided =  $144 \text{ m}^3$

Dimensions (internal) for rectangular tank =  $7.3 \times 12.3 \times 1.6 \text{ m}^3$

#### 6.3.3. Pipeline design

Pipeline design was done according to “handbook of architectural technology”.

Design was done using an excel sheet. It is shown in annex 6.

#### **Steps used in calculations**

The loading units for each pipeline were identified.

Flow rate required for each pipeline was found.

A diameter for the pipe was estimated according to the flow rate and the losses of head were calculated.

By comparing it to the head available, a final diameter for pipe was selected. (Annex 6.2)

Selected pipe diameters were shown in tables 6.1

**Table 6.6.1 Selected pipe diameters for a typical 3 bed room apartment**

pipe number	selected diameter(mm)
2	38
3	25
4	25
5	25
6	25
7	25
8	25



**Table 6.6.2 Selected pipe diameters for vertical pipes on top 5 floors**

Pipe number	Selected diameter(mm)
1-1	75
1-2	75
1-3	75
1-4	75
1-5	75

**Table 6.6.3 Typical pipe sizes for 2 bed room apartment**

Pipe line number	Selected diameter(mm)
12	38
13	25
14	25
15	25
16	25

<b>17</b>	25
<b>18</b>	25
<b>19</b>	13
<b>20</b>	13

---



University of Moratuwa, Sri Lanka.  
Electronic Theses & Dissertations  
[www.lib.mrt.ac.lk](http://www.lib.mrt.ac.lk)

## 6.4. ABOVE GROUND WASTE WATER DISPOSAL SYSTEM

In order to design the waste water disposal for 45 storey building, it is better to provide grey water pipe and black water pipe separately. Separate pipe for water closets and another pipe for other appliances.

### 6.4.1. Design the Size of the Soil (Black Water) Pipe

Two vertical stack pipes are used for the whole building. One pipe for two apartments which include a 3 bedroom apartment and a 2 bedroom apartment

It will provide 100mm diameter pipe from water closet to main slightly inclined pipe of one apartment.

It will provide 100mm diameter pipe for the main soil pipe of an apartment which connecting the vertical stack pipe.

Inclinations of those pipes are 1:24

One pipe will serve 6 WC's

Therefore no of discharge units for uppermost 10 floors =  $6 \times 10 \times 10 = 600$

(Assume it is for domestic use and 14 liter water closets are used)

Therefore it can be used 100mm pipe for uppermost 10 floors

No of discharge units for next 25 floors =  $600 + 6 \times 15 \times 10 = 2100$

Therefore it can be used 125mm pipe for next 25 floors

No of discharge units for final 10 stories =  $2100 + 5 \times 10 \times 6 = 2400$

But for safety purposes it will be using 150mm pipe for final 10 stories.

Main vent stack pipe will be provided with a diameter of 175mm according to the code of practice 304.

It will provide 50mm pipe from water closet to main vent stack pipe

### 6.4.2. Design of Pipes for Grey Water

Two vertical stack pipes are used for the whole building. One pipe for two apartments which include a 3 bedroom apartment and a 2 bedroom apartment

Shower pipe diameter will be 38mm

Sink pipe diameter will be 38mm

Wash basin pipe diameter will be 32mm

Inclination of 1:24 will be provided for all above pipes.

One pipe will serve 8 wash basins, 8 showers and 2 sinks

**Table 6.4 Calculation of discharge units per floor of one pipe**

appliances	no of appliances	discharge unit	total discharge units
bath	8	6	48

wash basin	8	1	8
sink	2	6	12
		total	68

No of loading units for uppermost 10 floors=  $68 \times 10=680$

The vertical stack of 100mm diameter will be provided for uppermost 10 floors

No of loading units for next 25 floors= $68 \times 35=2380$

The vertical stack of 125mm diameter will be provided for next 25 floors

Other 10 floors will be provided with 150mm pipe for higher safety purposes.



University of Moratuwa, Sri Lanka.  
Electronic Theses & Dissertations  
[www.lib.mrt.ac.lk](http://www.lib.mrt.ac.lk)

## 6.5. BELOW GROUND WASTE DISPOSAL SYSTEM

Two separate systems are used for grey water and black water below ground waste disposal system. Waste water is collected at the ground floor level and sent to the treatment plant.

### 6.5.1. Assumptions

- Waste water discharge is same as water consumption per capita equal to 180 lpcpd (liters per capita per day)
- Duration of water usage is 12 hours
- 25 % of per capita discharge is black water
- Peak factor is 4
- Self-cleansing velocity is 0.9 m/s
- Peak flow is taken as half bore of the pipe

Total population of the building = 600

Total waste water discharge = 600 x 180 = 108 m<sup>3</sup>/day

Peak discharge =  $\frac{108000}{12 \times 3600} \times 4 = 10$  l/s

Chezy formula -  $V = C\sqrt{mi}$

C – Chezy coefficient = 55  
 m – Hydraulic mean depth =  $\frac{\text{wetted area}}{\text{wetted perimeter}} = \frac{\pi r^2/2}{\pi r} = r/2$

### 6.5.2. Soil Drainage

$$Q = VA$$

$$0.01 \times 0.25 = 0.9 \times \frac{\pi}{8} \times d^2$$

$$d = 84 \text{ mm}$$

For convenience 100 mm diameter soil stack is used

Velocity of the soil stack

$$0.01 \times 0.25 = v \times \frac{\pi \times 0.1^2}{8}$$

$$v = 1.1 \text{ m/s}$$

This velocity is greater than self-cleansing velocity. Therefore no issues about blockages

For soil drainage,

$$0.8 = 55 \times \sqrt{\frac{0.075}{4} * i}$$

$$i = 0.011$$

Provide 1:175 slopes

### 6.5.3. Waste water drainage

$$Q = VA$$

$$0.01 \times 0.75 = 0.9 \times \frac{\pi}{8} \times d^2$$
$$d = 146 \text{ mm}$$

For convenience 150 mm diameter pipe is selected.

To maintain the velocity, it is needed to maintain necessary inclination

For waste water drainage

$$0.8 = 55 \times \sqrt{\frac{0.15}{4} * i}$$
$$i = 0.006$$

Provide 1:400 slopes



University of Moratuwa, Sri Lanka.  
Electronic Theses & Dissertations  
[www.lib.mrt.ac.lk](http://www.lib.mrt.ac.lk)



## 6.6. SOLID WASTE MANAGEMENT

### 6.6.1. Design of the chute for the high rise building

These are fabricated according to and confirm to,  
**British Standards 1703: 1977,**  
**BS 5906: 1980 and VDI 2162**

Finding the chute thickness  
 For 45 storey building  
 1-9 storeys ----3.0 mm  
 11-30storeys ----2.0 mm  
 31-45storeys ----1.5 mm

Its selected stainless steel type 304 for the chute design according to BS 1449

	Solid Waste (kg)	Liquid Waste (l)
Cardboard stacked flat or baled, folded newspaper	0.5	1.0
Food Waste, well compacted	1.5	2.5
Vegetable waste, uncompact	2.5	7.5
Empty Bottles	1.0	3.3
Mixed general refuse, similar to domestic	0.5	3.3
General office waste and paper	0.3	6.0
Waste paper loose in sacks	0.1	5.0
<b>Total</b>	<b>5.4</b>	<b>28.6</b>

The chute is selected as an indoor chute. This can be fixed either through the floor slab of the building or fix within the vertical shaft. In our design we have allocated space in service core for the refuse chute.

#### Selecting the size of the chute

Number of apartments per chute is more than 50. Therefore we have to select 900mm diameter chute.

The top of the refuse chute has to be provided with vents and fans, therefore a suitable arrangement can be provided as follows. 230mm vent pipes will be provided.

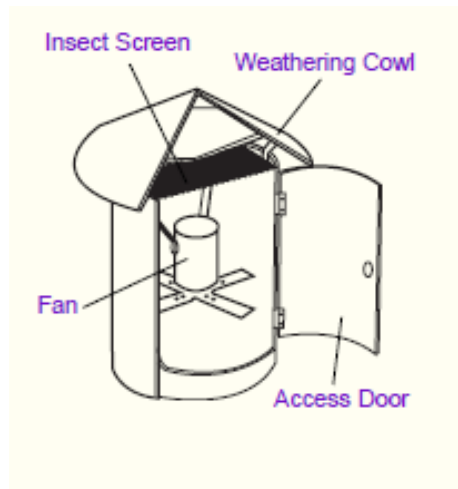
**Figure 6.2 Top of the refuse chute****Providence of a cleaning unit**

Automatic chute cleaning system can be provided as follows,  
This system will be coming with a disinfecting system and a sanitizing unit. Operating and maintenance are very easy to provide with this system.

**Fire protection and fire fighting for chute**

Normally glass bulb sprinklers are recommended for fire protection inside the chute.

**Finding chute hopper door sizes**

According to the standard, for 900mm diameter chute its used 700 x 950 mm (28'' x 36'') cover and 600 x 600 mm (24'' x 24'') door size.

**Finding capacity of the garbage container**

According calculations done at the beginning the wastage per apartment can be approximate to 0.3 m<sup>3</sup> per week

Therefore total solid waste = .03 x 40 x 4=4.8 m<sup>3</sup>

It can be use a 5m<sup>3</sup> size Garbage container for our one and it can be used two days to collect waste per week

**Figure 6.3 Overall Design of Chute**

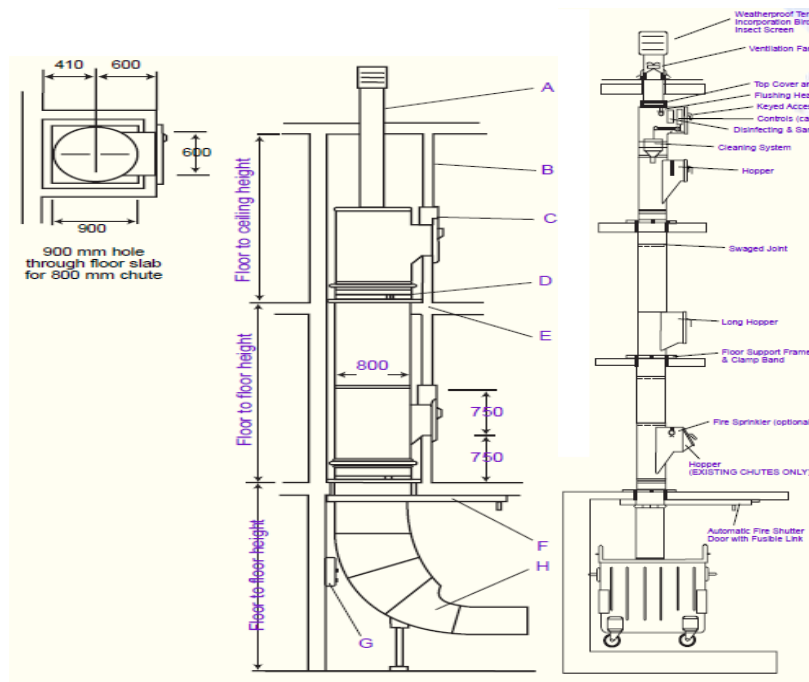

- A - 150mm diameter vent (or as specified).
- B - Face wall built after erection of chute.
- C - Electrically interlocked side-hung doors.
- D - Chute support mounted on structural floor.
- E - Floor opening to be in filled by builder.
- F - Fire shutter door fixed to underside of floor slab.
- G - Master control panel for interlocks (1500 mm off floor level).
- H - Short deceleration tracker.

## 6.7. FIRE FIGHTING SYSTEM

### 6.7.1. Proposed Fire Fighting Systems

In sky residencies is a high rise building with a 47 stories we proposed 3 fire fighting systems (Annex 6.3)

- Fire Extinguishers
- Wet riser
- Hose Reels

It is practiced to place a sprinkler system in a high rise building, since this is an apartment building sprinkler system is not suitable.

Before going for further details it is better to know the way fire can create, Fire is a chemical reaction involving rapid oxidation or burning of a fuel. It needs to four elements to occur

- Fuel – Fuel can be any combustible material- solid, liquid or gas. Most solids and liquids become a vapor or gas before they will burn.
- Oxygen – The air we breathe is about 21% oxygen. Fire only needs an atmosphere with at least 16% oxygen
- Heat – Heat is the energy necessary to increase the temperature of the fuel to a point where sufficient vapors are given off for ignition to occur.
- Chemical Chain Reaction – A chain reaction can occur when the three elements of the fire are present in the proper conditions and proportions. Fire occurs when this rapid oxidation or burning takes place. Take any of these factors away and the fire cannot occur or will be extinguished if it was already burning.

#### **Fire Extinguisher system**

There are several types of fire extinguishers that can be used in a fire, For example Carbon Dioxide extinguishers

As according to the UL rating there are there are three ratings in a fire extinguisher. Which can be named as a class A and Class B:C. These numerical rating allows to compare the relative extinguishing effectiveness of various fire extinguishers. The rating A is a water equivalent rating.

Assume following example,

Extinguisher is rated 4A:20B:C, A is equivalent to 1.25 gallons of water. B:C rating is equivalent to the amount of square footage that the extinguisher can cover. C indicates it is suitable for use on electrically energized equipment. The UL rating is found on the extinguishers label or name plate band

**Figure 6.4 The Extinguisher Label**



**Table 6.5 Type of Extinguisher**

Extinguisher Type	Agent	Class	Sample Applications
Multi-Purpose Dry Chemical	Mon Ammonium Phosphate	ABC	Offices, Hotels, Schools and Warehouses
Regular Dry Chemical	Sodium Bicarbonate	BC	Vehicles, Training and Laboratories
Purple K Dry Chemical	Potassium Bicarbonate	BC	Oil Industry, Airport Ramps, Military and Fuel Services
CO <sub>2</sub>	Carbon Dioxide	BC	Factories and Food Processing Plants
Halotron	Halotron I	A	Military, Computer Room, Aircraft and Museums
Water	H <sub>2</sub> O	A	Storerooms, B
Foam	AFFF/FFFP	AB	Fuelling Areas, Manufacturing and Construction Sites

From the above mentioned type of extinguishers we are designed to place two types of fire extinguishers which will covers most probable fires that can be occur.

- Carbon Dioxide Extinguishers

Co<sub>2</sub> extinguishers are generally red have a large tapered nozzle and very heavy. These are all high pressure cylinders. CO<sub>2</sub> cylinders do not have a pressure gauge. They must be weighted to determine the amount of contents.

- ABC Dry Chemical Extinguisher

ABC rated multipurpose dry powder extinguishers are the most common. They are almost always red in color and have either a long narrow horse or no hose. It contains mono ammonium phosphate powder with dry nitrogen.

There are four things to be considered when installing portable fire extinguishers

- Identify the type of hazard
- Determine the size of the extinguishers
- Establish the quantity by the coverage
- Distribute the portable fire extinguishers per the allowable travel distance

Since this is apartment building hazard type can be taken as light (low) hazard

As according to the NFPA 10 , 2002 edition,

Minimum rated Single extinguisher- 2-A

Maximum floor area for extinguisher –11,250 ft<sup>2</sup>

Maximum travel distance to the extinguisher – 75 ft

With reference to the regulations proposed two types of extinguishers can be placed in two positions in one apartment floor and also same in car parking floor.

Approximately total floor area is around 9000ft<sup>2</sup> so this design can be acceptable.

Travel distance is also less than the 75 fts

### **Wet Riser system**

As according to the regulations wet rising main shall be installed in buildings with habitable height exceeding 60m so this far more than 60 m it is recommended to install the wet riser system as the fire fighting method.

Capacity of the water supply from the public mains and the storage capacity for a wet rising main system shall comply with the requirements in SS CP 29 Code of Practice for Fire Hydrant systems and Hose Reels.

1. The water supply to the rising mains should be kept entirely independent of water supplies feeding other installations including those for other fire fighting systems.
2. Means of supply for wet rising mains

BS9990 requires that the minimum volume of stored water for a wet riser is two interconnecting tanks each with a volume of 22.5m<sup>3</sup> each giving a total of 45m<sup>3</sup>. The other 22.5m<sup>3</sup> can be supplied automatically to the two tanks from the service main through ball valves fitted to each tank. Wet rising mains should be placed in the service duct. Pump arrangement for Wet risers can be either two electrically-driven units or one electric and one diesel engine driven units. One pump is designated as the 'duty' pump, and the other acts as a standby should the duty pump fail or additional pumping capacity be required. The system has a small capacity 'jockey pump' which starts automatically to maintain system pressure and prevent intermittent starting and stopping of the main pumps.

Wet fire mains should be similarly checked and, in addition, the water storage tanks and booster pumps should be checked for operational serviceability. Defects in equipment should be rectified as soon as possible by a competent person and if delay ensues, the fire service should be warned, and warning notices should be posted in the building at the appropriate place. The fire service should be informed as soon as the equipment is serviceable again.

The pipes in wet risers are full of water at all times and have pumps that deliver the water to the outlets, these pumps drawing water from storage tanks. The pumps operate when the pressure in the rising mains drops when a landing valve is opened. They do not depend on the fire brigade appliance or water from the local mains.

### **Hose Reels**

Hose reels can be placed in each floor with considering the length of the hose. There should be sufficient length to a hose reel that can be carried out to any place of the building so the main concern is the length of the hose reel and the water supply system to the hose reel.

With reference to the BS3169:1981 .The hose reel should be of 20mm or 25mm nominal diameter, non-kinking reinforced rubber or reinforced PVC to either BS3169:1981 Type A or AS1221:1983, not exceeding 30 m in length and terminating in "shut-off" branches with 4 mm or 6 mm nozzles.

## **6.7.2. Fire Detection Systems**

Smoke Detectors used as fire detection system in the high rise building. Smoke detectors are placed in the

- Fan and electrical rooms
- Return air ducts and plenums
- Elevator lobbies
- Corridors on each floor
- Within the living room and the each bed room of the apartment

High rise fire alarm system is also installed to the building which will monitor and notified a fire.

## **6.7.3. Emergency Evacuation for People with Disabilities**

It is quite important to have emergency evacuation system in a high rise building in case of emergency, in the sky residencies it is proposed following evacuation method.

Service core made as a fire resistive core for a certain time by placing fire resisting doors which will delay the fire to spread through the service core. For few hours service core can be used to evacuate the people from the building lifts can be used to evacuate disable people.

## 6.8. Air Conditioning

Building required all bed room of each floor to be air conditioned. Cooling load requirement for the each section was calculated manually according to a standard calculation method.

**Table 6.6 Air conditioning loading requirement**

Location		A/C load (BTU/Hr)
Three Bed Room Apartment	Bed room 01	19,496.2
	Bed room 02	20,597.0
	Bed room 03( Master bed room )	22,648.0
Two Bed Room Apartment	Bed room 01	20,148.0
	Bed room 02( Master bed room )	22,648.0

Individual split type air conditioning unit be used for all bed room. Therefore use 24000 btu/hr machines for all apartment room.

## 6.9. ELECTRICAL SUPPLY

For the building, it is essential to provide an electrical system which is reliable and effective. In this project we are using direct power supply from C.E.B., generators in case of a power cut and solar power to fulfil electricity requirement. Three phase electric system is used.

### 6.9.1. Lighting design

For this building L.E.D. lighting system is adopted in order to save energy and it is also a sustainable product. It consumes less energy than the most other types of lamp, has longer life time, is a mercury-free product and can recycle. Lighting design is carried out using lumen method and required data is obtained using MS 1525 recommendations.

**Table 6.7 12w Par 38 Led Light Bulb**

Model Number	LR-PAR38W12N-12
LED Type	Power LED 1W
Voltage (V/AC)	220V
Power (W)	12W
Luminous Effect (LM/W)	90-100
Average Lifetime	25000-45000 h

Maintenance factor (0.95) and utilization factor (0.7) was selected according to the Philips LED lamp manufacturer's guide.

### Sample calculation for the office area

Applying,



$$N = \frac{E \times A}{F \times U \times M}$$

Where, N = Number of fittings

A = Floor area

F = Lumens for lamp

U = Utilization factor

E = Lux on working plane

M = Maintenance factor

- For living area in Three Bed Room Apartment

Gross floor area for Living Area (A) = 70.6 m<sup>2</sup>

Lumens for lamp (Living Area) = 50 (MS 1525 recommendations)

$$N = \frac{70.6 \times 50}{1200 \times 0.7 \times 0.95}$$

$$N = 4$$

Total number of fittings for Living Area = 4

Calculations are carried out for all the floors and tabulated as follows:



University of Moratuwa, Sri Lanka.  
Electronic Theses & Dissertations  
www.lib.mrt.ac.lk

Table 6.8 Summary of the lighting fittings

		Lumens for lamp	Gross floor area	Number of fittings
Three Bed Room Apartment	living area	50	70.6	4
	master bed room	50	17.63	1
	bed room 1	50	12.36	1
	bed room 2	50	10	1
	kitchen	150	30.29	6
	maid room	50	7.5	1
	bath room	100	5.5	3
	balcony			3
Two Bed Room Apartment	living area	50	48.57	3
	master bed room	50	17.63	1
	bed room 1	50	12.36	1
	kitchen	150	29.96	6
	maid room	50	7.5	1

	bath room	100	5.55	3
	balcony			3
For circulation area	horizontal circulation area	150	32.36	6
	service core area	50	23.38	1
	service duct	150	5.89	1
	landings	150	4.5	1
	stairs	100	10.8	1
Car park area	Car park area	50	1791	112
<b>Total Lighting Fittings</b>				<b>160</b>

**Table 6.9 Summary of the Socket Outlet**

	Switch sockets	Location	Number of fittings	
Three Bed Room Apartment	6A	Master bed room	2	
		Bed room-1	1	
		Bed room-2	1	
		Kitchen	2	
		Living area	4	
		Dining area	1	
		Maid room	1	
		Bath room	3	
		13A	Living area	1
		16A	Kitchen	2
		Bed room	3	
Two Bed Room Apartment	6A	Master bed room	2	
		Bed room	1	
		Kitchen	2	
		Living area	3	
		Dining area	1	
		Maid room	1	
		Bath room	3	
		13A	Living area	1
16A	Kitchen	2		



University of Moratuwa, Sri Lanka.  
Electronic Theses & Dissertations  
www.lib.mrt.ac.lk

$$\begin{aligned} \text{Total electrical demand of floor} &= 160 \times 12 + (6 \times 28 + 13 \times 2 + 16 \times 7 \\ \text{(with air condition)} &+ 7.5 \times 2) \times 230 + 7.038 \times 5 \\ &= 110.94 \text{ kW} \end{aligned}$$

$$\begin{aligned} \text{Total electrical demand of building} &= 110.94 \times 46 \\ \text{(with air condition)} &= 5.103 \text{ MW} \end{aligned}$$

$$\begin{aligned} \text{We assume use 40\% of Total} &= 5.103 \times 0.4 \\ \text{demand} &= 2.04 \text{ MW} \end{aligned}$$

$$\begin{aligned} \text{Assume electric usage of building} &= 50 \text{ W/m}^2 \\ \text{Total electrical demand of building} &= 863 \times 50 \times 46 \\ \text{(with air condition)} &= 1.98 \text{ MW} \end{aligned}$$

We have to establish substation for that building to provide that amount of electrical demand. We use 2 MW transformers for substation.

### 6.9.2. Substation

A sub-station is required for the conversion, transformation and control of electrical power. It is used where large buildings or complexes of buildings require greater power than the standard low or medium potential of 230 and 400 volts. A sub-station must be constructed on the customer's premises. It is supplied by high voltage cables from the electricity authority's nearest switching station. The requirements for a sub-station depend upon the number and size of transformers and switchgear.

A transformer is basically two electric windings, magnetically interlinked by an iron core. An alternating electromotive force applied to one of the windings produces an electromagnetic induction corresponding to an electromotive force in the other winding. Corresponding to an electromotive force in the other winding

Figure 6.5 Layout of the substation

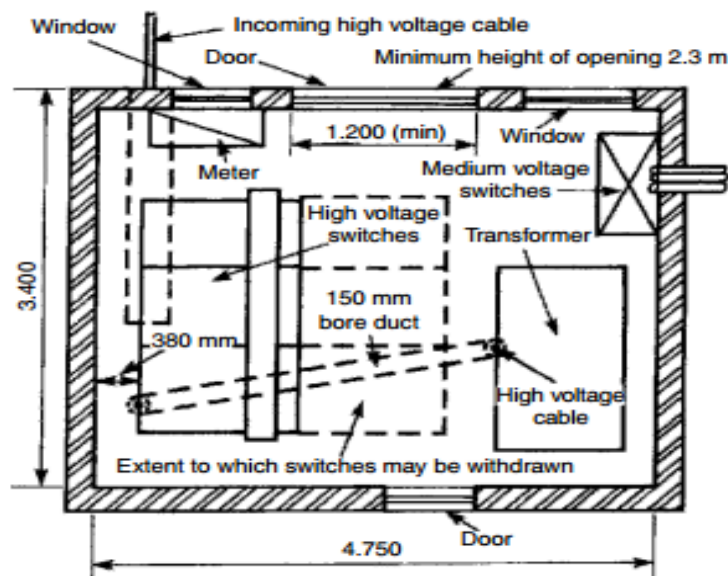

### 6.9.1. Consumer Unit

Electrical installations required a separate fuse and isolator for each circuit. Modern practice is to rationalize this into one 'fuse box', known as a consumer's power supply control unit or consumer unit for short. This unit contains a two-pole switch isolator for the phase/live and neutral supply cables and three bars for the live, neutral and earth terminals. The live bar is provided with several fuse ways or miniature circuit breakers (up to 16 in number for domestic use) to protect individual circuits from overload. Each fuse or mcb is selected with a rating in accordance with its circuit function. Traditional fuses are rated at 5, 15, 20, 30 and 45 amps whilst the more modern mcbs are rated in accordance with BS EN 60898: Circuit breakers for over current protection for household and similar installations.

### 6.9.2. Rising main electricity distribution

For the ten stories green building a rising main supply system is used. In the rising system copper busbars run vertically inside trunking and are given support by insulated bars across the trunking chamber. The supply to each floor is connected to the rising main by means of tap-off units. To balance electrical distribution across the phases, connections at each floor are spread between the phase bars.

**Figure 6-6 The rising main system with fire prevention**

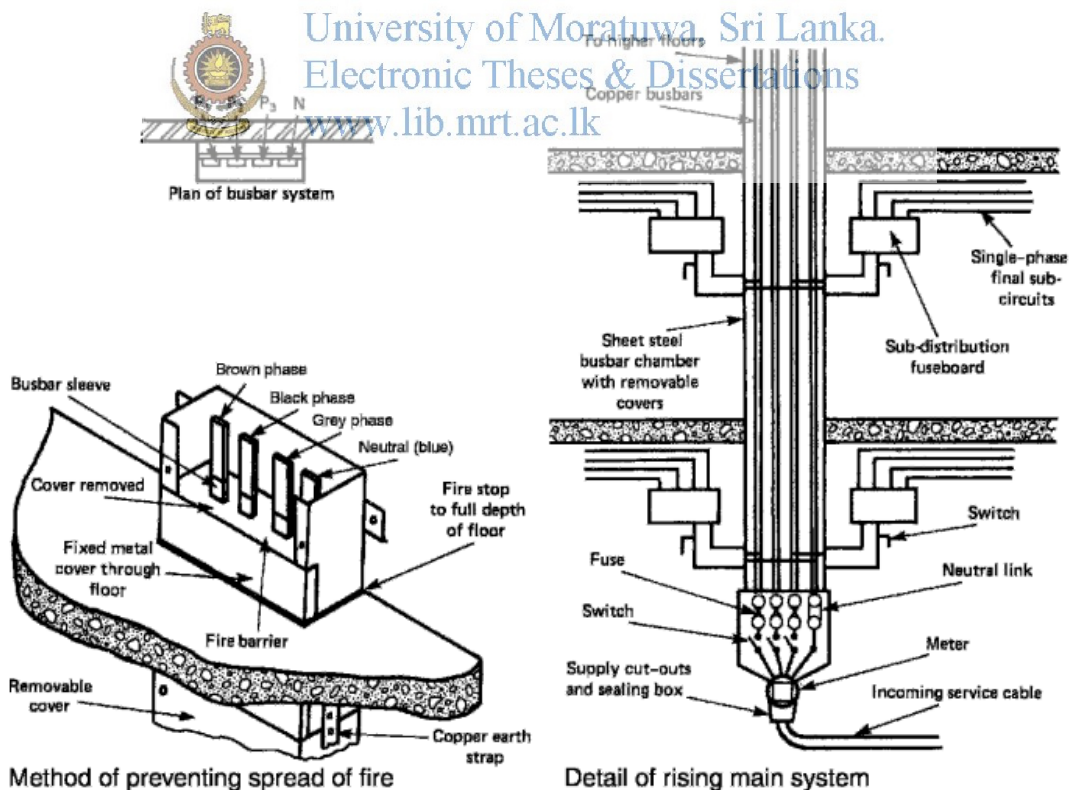

To prevent the spread of fire and smoke, fire barriers are incorporated with the busbar chamber at each compartment floor level. The chamber is fire stopped to the full depth of the floor.

## 6.10. Building Services integration

Building services are an important part of the building fabric for high-quality modern buildings. There are so many services.

- Air Conditioning
- Electrical
- Fire Services
- Plumbing & Drainage
- Lift Services

Many services works are required to run within the building, the layout of which needs to be carefully coordinated with other building works. Also a large number of building services are required to fit-out carefully with the building finishes works. Building services works exhibit certain degree of specialization that they have their own concern in design, installation and logistic requirements. Plant and equipment for many building services are heavy and huge in size that needs special accommodation and handling during the construction process, for example

Machinery: air handling units, transformer, generator, lift machine, pumps

Pipe: for water supply, gas, drain, fire services

Duct: ventilation and air distribution system

Install all pumps in machine room in ground floor of building and transformer and generator install in transformer room away from the building.



University of Moratuwa, Sri Lanka.  
Electronic Theses & Dissertations  
www.lib.mrt.ac.lk

Figure 6.7 Service Duct Layout

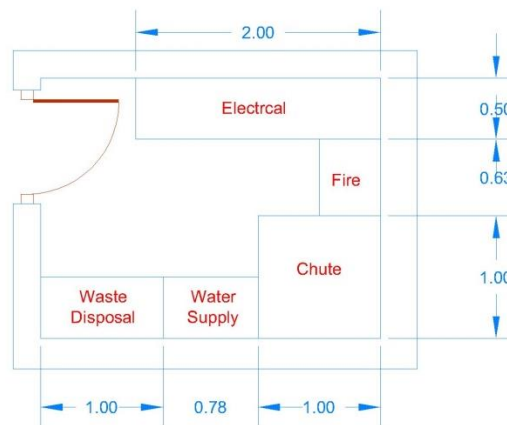

All services go through the service duct and from duct to apartment go through the top of roof ceiling.

## 6.11. Thermal Performance Assessment

### 6.11.1. INTRODUCTION

Thermal comfort is an important part in the indoor air quality. Thus assessment of thermal performance is an important task in each and every project. Thus it had been decided to analyse the thermal performance of our building using DEROB-LTH (Dynamic Energy Response Of Buildings).

DEROB-LTH which is an acronym for Dynamic Energy Response of Buildings of Lund Institute of Technology, Sweden, is a MS Windows based flexible simulation tool. The program consists of 8 modules and six of them are used to calculate values for temperatures, heating and cooling loads of the indoor environment. The calculations are performed in a dynamic way for each hour during a specified period of simulation. Properties for the indoor climate of the building are calculated based on the climatic factors such as outdoor temperature, solar radiation and the sky temperature.

DEROB can be used to analyse heating, ventilation and air conditioning (HVAC) of a building. DEROB-LTH supports cooling and heating according to two different types of schedules.

1. Calculating indoor temperature if the equipment capacity is known.
2. Calculating the heating and cooling loads if the indoor temperature schedule is known.



University of Moratuwa, Sri Lanka.  
Electronic Theses & Dissertations  
[www.lib.mrt.ac.lk](http://www.lib.mrt.ac.lk)

Air exchanges between volumes can be modelled in three ways

1. Infiltration between a volume and the outdoor air can be specified according to two different types of schedules.
2. Air flow caused by advection connections between volumes is dependent on the openings between two volumes, temperature differences and static pressure.
3. Forced ventilation between the volumes and the outdoor air is specified by direction and flow. The same forced ventilation is used during the whole period of simulation.

In this report, I have made an assessment of temperature variation of commercial area with different wall material and with light and dark colour for the wall surfaces. And also cooling load were calculated when the A/C was operated between 8am and 8pm.

In the actual situation roof slab is not directly exposed to the sun. But in the modelling this was exposed to sun. So in order to bring the actual situation in the modelling vertical shading devices were applied at roof slab level.

### 6.11.2. PROCEDURE

1. Necessary opaque materials which are not in the library were added
2. Walls, roofs and floors were defined by the appropriate materials and suitable thicknesses

3. To eliminate the effect of upper and bellow floors, 500mm thick mineral wool layer was placed with the slab
4. Glass types and widow types were defined ((There is a court yard in the building. we have to model the building considering court yard area as a one volume. So glass which has 98% trans and 1% refflec were defined.)
5. All necessary building element were defined
6. Properties of the environment were taken according to the outdoor properties (climatic data)

**Climatic data**

Station - Rajagiriya  
 Latitude - 7°  
 Longitude - 79°  
 Altitude - 10 m  
 Time meridian- 83°  
 Year - 2015  
 Month - 04  
 Date - 04  
 Temperature Max- 32.5°C /Min- 26.8°C , Relative humidity Max- 89% /Min- 66%

**Table 6.10 Properties of light colour and dark colour**

Color type	Absorptance (%)	Emittance (%)
Light	30	87
Dark	70	87

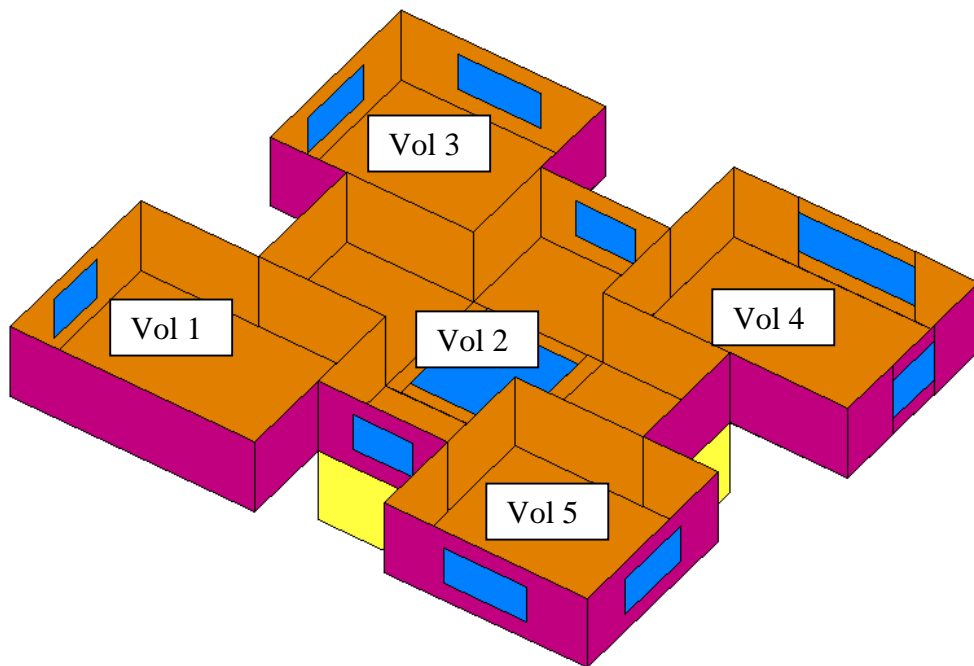

Eye view. Altitude: 35 Azimute: 235  
Exit:Esc Step:S/s Zoom:+/- Rotate:Arrows Move:Ctrl+Arrows

**Figure 6.8 DEROB model without roof slab**



University of Moratuwa, Sri Lanka.  
Electronic Theses & Dissertations  
[www.lib.mrt.ac.lk](http://www.lib.mrt.ac.lk)

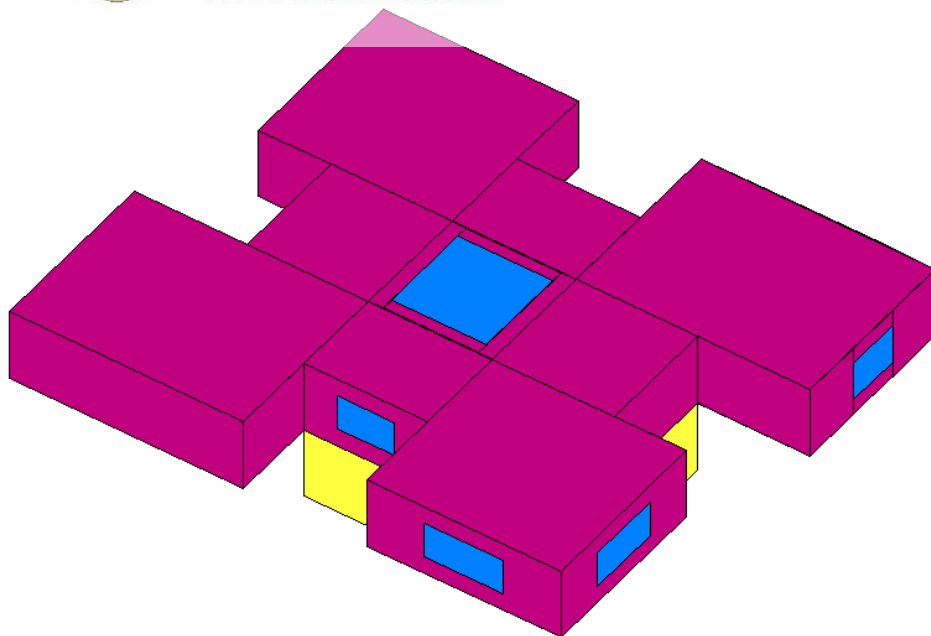

Eye view. Altitude: 35 Azimute: 235  
Exit:Esc Step:S/s Zoom:+/- Rotate:Arrows Move:Ctrl+Arrows

**Figure 6.9 DEROB model with roof slab**



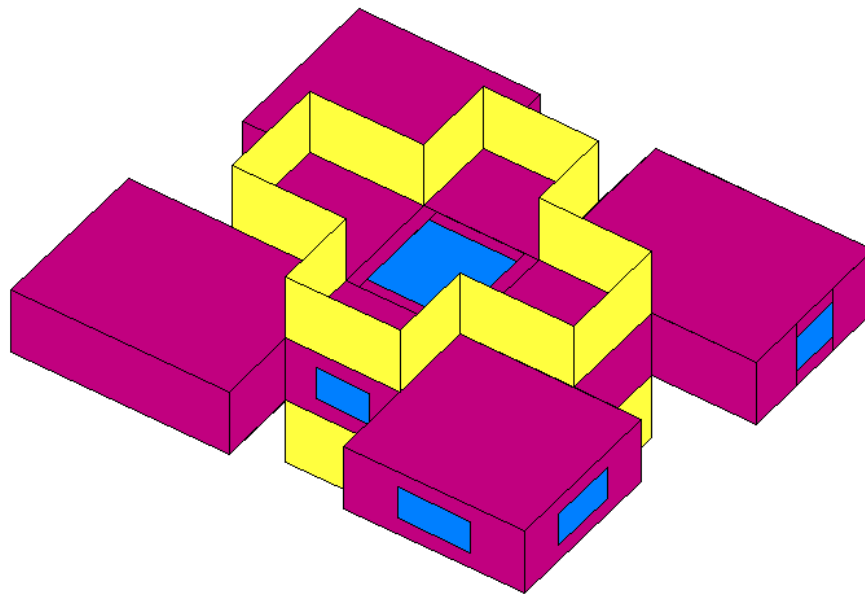

Eye view. Altitude: 35 Azimute: 235  
Exit:Esc Step:S/s Zoom:+/- Rotate:Arrows Move:Ctrl+Arrows



University of Moratuwa, Sri Lanka.  
Electronic Theses & Dissertations  
[www.lib.mrt.ac.lk](http://www.lib.mrt.ac.lk)

**Figure 6.10 DEROB model with roof slab and shadings**

## Results

**Table 6.12 Indoor temperature variation in °C (CSEB light colour)walls)**

Hour	vol1	vol2	vo3	vol4	vol5
1	31.4	31.2	31.3	31.2	31.4
2	31.2	31	31.1	31	31.2
3	31	30.9	30.9	30.8	31
4	30.8	30.7	30.8	30.6	30.8
5	30.7	30.7	30.6	30.5	30.7
6	30.6	30.6	30.5	30.4	30.5
7	30	30	30.1	29.7	29.9
8	30.1	30.2	30.3	29.6	30
9	30.4	30.8	30.7	29.8	30.3
10	30.9	31.7	31.2	30.4	30.9
11	31.4	32.5	31.7	30.9	31.4
12	31.7	32.9	31.9	31.3	31.7
13	32	33.2	32.1	31.5	32
14	32.2	33.2	32.3	31.8	32.2
15	32.3	33.2	32.3	32	32.3
16	32.4	33	32.3	32.2	32.4
17	32.4	32.6	32.3	32.2	32.4
18	32.2	32.2	32.2	31.8	32.1
19	32.2	32.1	32.2	31.8	32.2
20	32.2	32.1	32.2	31.8	32.2
21	32.1	31.9	32	31.8	32.1
22	32	31.7	31.9	31.7	32
23	31.8	31.5	31.7	31.5	31.8
24	31.6	31.4	31.5	31.3	31.6

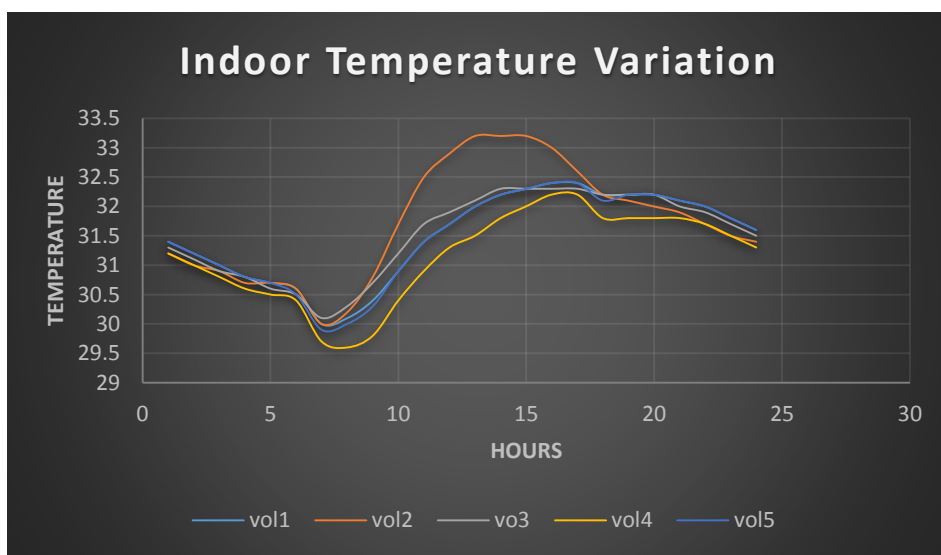

**Figure 6.11 Indoor Temperature Variation**

Hour	brick	cseb	concrete
1	31.3	31.4	31.4
2	31.1	31.2	31.2
3	30.9	31	31
4	30.7	30.8	30.8
5	30.6	30.7	30.7
6	30.4	30.6	30.6
7	29.9	30	29.9
8	30	30.1	30
9	30.3	30.4	30.3
10	30.9	30.9	30.9
11	31.4	31.4	31.4
12	31.7	31.7	31.7
13	32	32	32
14	32.2	32.2	32.2
15	32.3	32.3	32.3
16	32.4	32.4	32.4
17	32.4	32.4	32.4
18	32.4	32.2	32.2
19	32.2	32.2	32.3
20	32.1	32.2	32.3
21	32	32.1	32.2
22	31.9	32	32
23	31.7	31.8	31.8
24	31.5	31.6	31.6

**Table 6.13 Temperature variation of vol\_1 with different wall material**

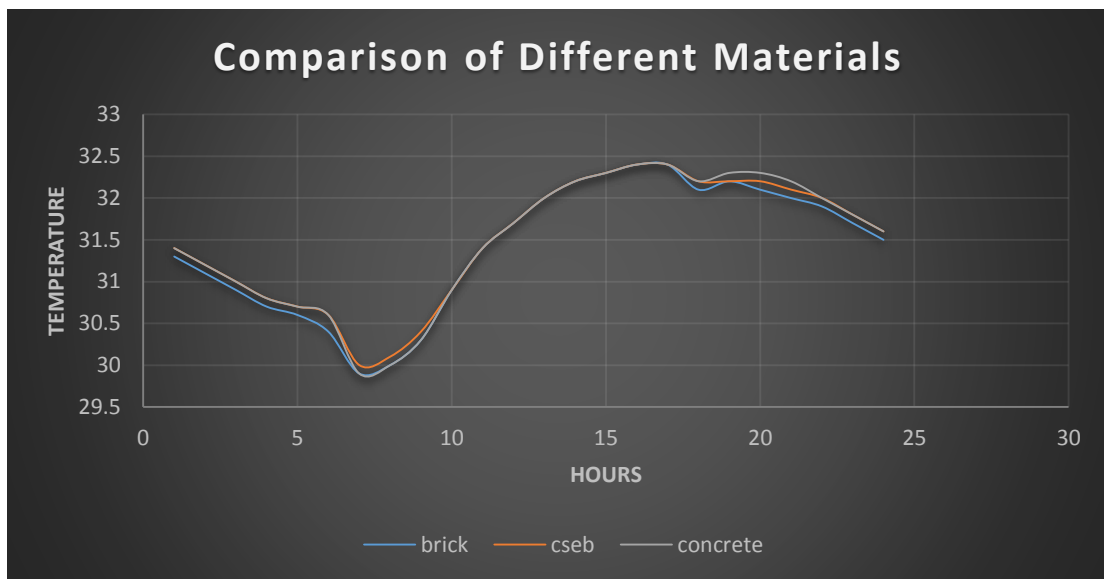

**Figure 6.12 Comparison of materials**

- We assigned different materials and various thicknesses for the members of the building, and the temperature inside the volume was observed.
- Dark and light colors were applied to the external and internal walls and the variation was observed. The indoor temperature was similar in case of white color compared with black.
- Finally the materials were selected in order to maintain the thermal comfort inside of the apartment.

## 6.12. MEASURES TAKEN TO INCREASE THE THERMAL COMFORT

- Other than the material selection, some of the following factors were considered in order to maintain the thermal comfort of the building.
- Orientation of the windows  
Windows were placed perpendicular to the wind direction. So this will enhance the thermal comfort of the building.
- Orientation of the building  
The orientation of the building is really important because it affects the thermal comfort inside the building. In order to minimize the direct sol-air temperature, it is essential to minimize the direct solar radiation penetrate in to the building. It is also necessary to minimize the gain of long wave radiant heat emitted by the building environment.

- Proper orientation

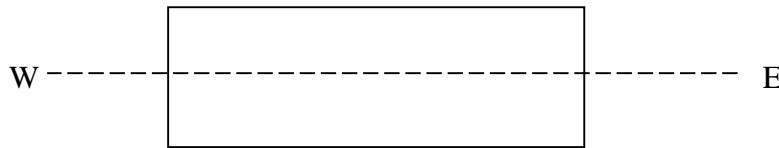

- Evaporative cooling

Evaporative coolers produce a moderate reduction in air temperature and increase humidity. They operate by passing hot air over water-saturated pads and the water evaporation effect reduces the dry-bulb temperature

- ❖ Roof top gardens, small gardens in each floor levels and vegetation around the building.
- ❖ Court yards having courtyards will also enhance the thermal comfort.
- ❖ Thermal insulation
- ❖ There are many different types of thermal insulation materials such as loose fills, foams, rock wool and boards. The material acts as a barrier, which retards heat flow in the hot seasons. We have planned to use these in our building.
- ❖ Control of solar radiation through shading

In order to control sun penetration to the interior of building it is important to provide exterior shading as a part of the architectural envelope design. Typically there are 3 method of solar radiation occurs and heat penetrates in to the building.

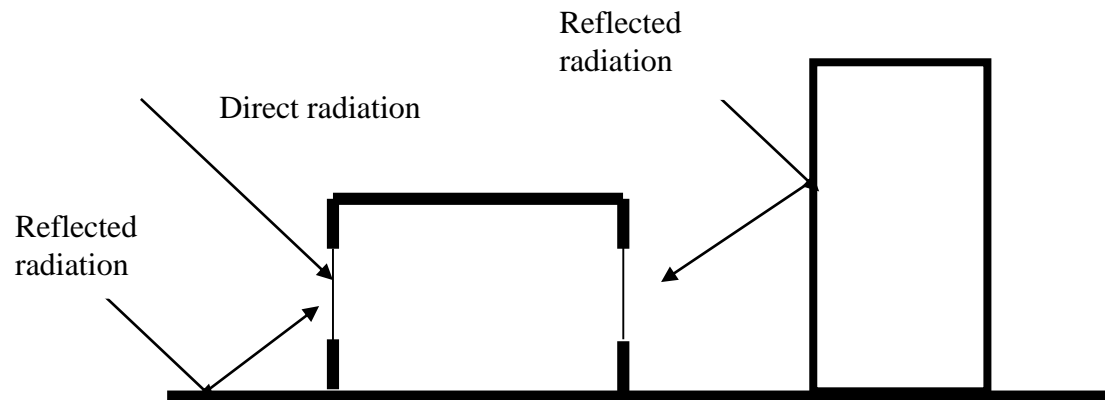

Exterior shading is greatly preferred over interior shading as it is important to keep the solar radiation from outside of the building

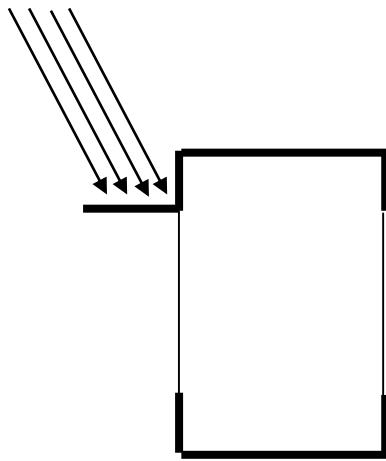

External shading – Overhang

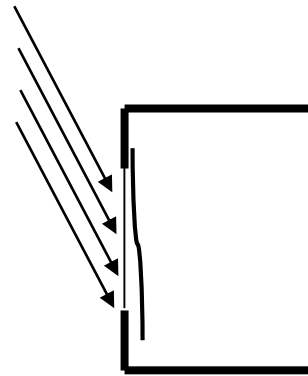

Internal shading – Curtain



Figure 6.13 Shading arrangement

## 7. ANALYSIS OF STRUCTURE USING SAP2000

### 7.1. Introduction

As this is a high rise building with 46 stories it is near impossible to analyse the structure manually. It will take months to finish calculations. We used Structural Analysis Package (SAP2000) to analyse this structure.

### 7.2. Methodology

In creating the model and analysing the structure following methodology was used.

- Preparation of general arrangement of floor plans and selecting element sizes using thumb rules.
- Identification of materials and their properties.
- Identification of loading arrangements.
- Creation of SAP2000 model.
- Analysing the model.
- Verification of the model with judgements.
- Checking the analysis results.

### 7.3. Preparation of general arrangement

The architectural drawings were used to make the general arrangement. According to the architectural drawings column, beam and secondary beam arrangement was decided. Columns were arranged as walls to allow them to hide inside walls. To avoid a transfer plate car park and apartment floors were arranged to be in the same grid. Secondary beams were added to take the additional wall load due to apartment partitions. The maximum span was found to be 12.8 m. we added some extra columns in order to make the structure stiff. Car park was arranged to be alternative floors of 1.6 m height and apartment floors were 3.6 m. Recreational floor was as high as 4.

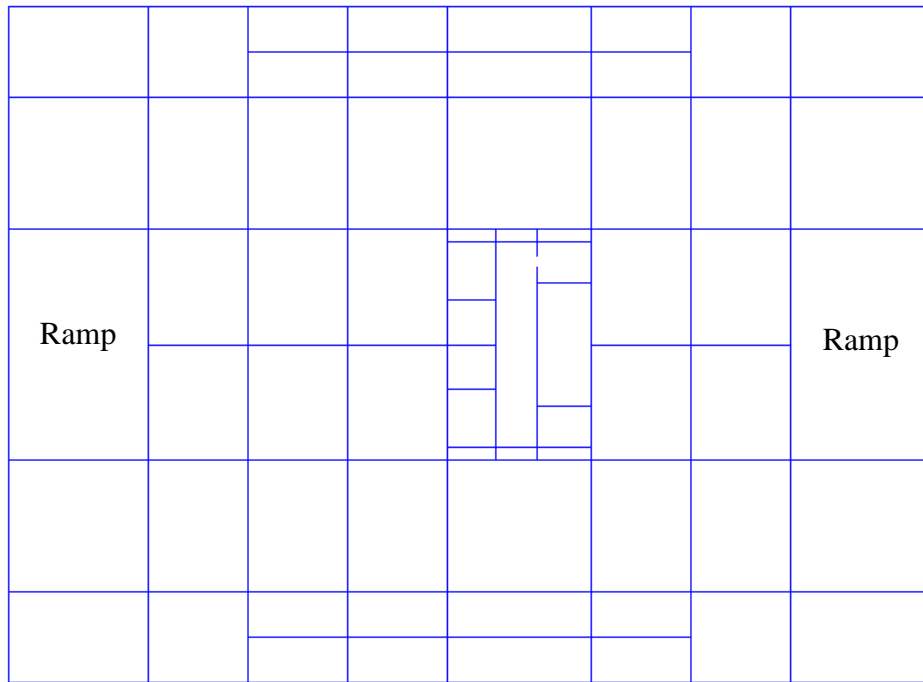

University of Moratuwa, Sri Lanka.  
 Figure 7.1 - General arrangement in car park floors  
 Electronic Theses & Dissertations  
[www.lib.mrt.ac.lk](http://www.lib.mrt.ac.lk)

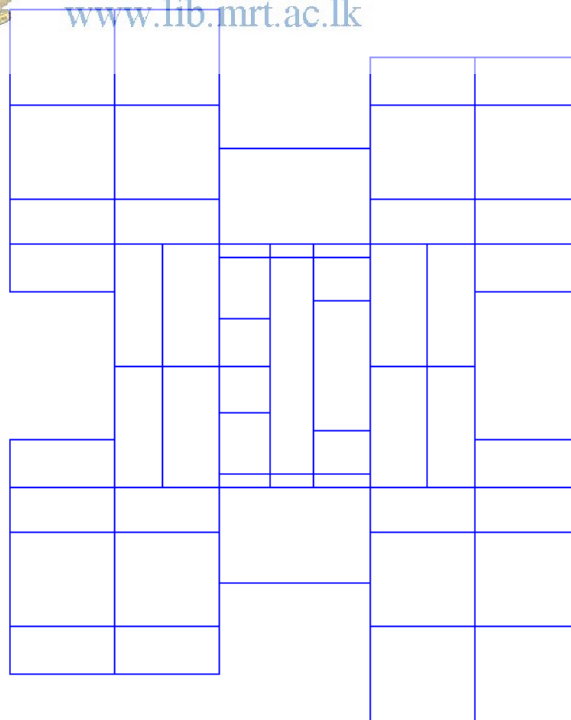

**Figure 7.2 - General arrangement in apartment floors**





**Figure 7.3 Idealized model**

### 7.3.1. Selection of element sizes

In selection of beam depth we used the rule beam depth in inches = span in feet. Beam breadth was selected as 350 mm and 250 mm to the provision of earth quake design detailing. Slab thickness was decided using the span to depth ratio. Column and shear wall sizes were decided by finding axial load approximately using the tributary area. All the element sizes were decided in provision to earth quake design and detailing. Typical element sizes were shown below in table 7.1.

Type	Sections	Dimensions(mm)
Beams	Main Beams	650mm x 250mm
	Secondary Beams	450mm x 250mm
Column	Car park	2500mm x 350mm
	Apartments	2500mm x 250mm

Shear wall	Outer walls	350mm
	Inside walls	250mm
Slabs	Service core	250mm
	Ramp	250mm
	Other slabs	150mm

**Table 7.1 - Typical dimensions of members**

In SAP 2000 modelling following aspects were considered for proper simulation of structural behaviour.

- Shear walls were modelled using thick shell. In high-rise buildings we have to account for shear deformation. So using thick shell will produce good results than thin shell.
- All the columns were modelled using membrane as we are not taking the moments into account.
- Dummy beam of 200mm x 100mm was used on shear walls and walls at each floor level to connect shear wall and beams because in SAP 2000 beam element has only five degree of freedom.

Further following load combinations was used according to BS 8110 part 1 Table 2 and AS 1170.1 for ultimate limit state condition. Beside SLS condition also used.

- 1.4 Dead + 1.6 Imposed
- 1.4 Dead + 1.4 Wind ( Both X & Y and diagonal as well as wind in opposite direction )
- 1.2 Dead + 1.2 Imposed + 1.2 Wind ( Both X & Y )
- Dead load + 0.4 Imposed + EQ
- Envelop of all combinations

## 7.1. Identification of proper materials and their properties

We used 2 grades of concrete in members. Slabs and beams are to be constructed in grade 35 and columns and shear walls to be constructed in grade 40 concrete. Partition walls adjacent to bathrooms are to be constructed using earth blocks and the other partition walls will be constructed using Durra boards. The material properties used are as below.

Concrete Grade	Grade 35 and 40
Weight	24kN/m <sup>3</sup>
Elastic Modulus: (BS 8110-part2)	24.6 x 10 <sup>6</sup> & 28.4 x 10 <sup>6</sup>
Poisson's Ratio	0.2

Thermal Expansion	$1 \times 10^{-5}$
-------------------	--------------------

**Table 7.2 - Material properties**

## 7.2. Identification of loading arrangement for the building

Slab loads were calculated using Table 3.16 of BS8110:Part1:1985 and assigned as distributed loads on beams. Self-weight of slabs were reduced using section properties to avoid calculating the slab weight twice. Wall loads were also applied to beams as distributed loads.

### 7.2.1. Dead loads

Dead loads from slabs were calculated and applied on beams. Further  $0.75 \text{ kN/m}^2$  for finishes and  $0.5 \text{ kN/m}^2$  for services were included. Wall loads were also calculated and applied on beams. Loads from cantilever balconies were applied as a UDL on the beam adjacent to it.

Wall type	Density (kN/m <sup>3</sup> )	Thickness (mm)	Height (m)	Weight (kN/m)
Durra panel	3.5	116+30	2.7	2.72
Earth block	20	250	2.7	13.5

**Table 7.3 - Wall loads**

In the analysis  $10 \text{ kN/m}$  was used for Durra panel and  $18 \text{ kN/m}$  was used for cement block walls.

### 7.2.2. Imposed load

Imposed loads were selected according to BS6399:Part1:1996 Table 1. In apartment floors imposed loads were used as  $1.5 \text{ kN/m}^2$  and  $2.5 \text{ kN/m}^2$  for car park floors. In the recreational floors imposed loads for gymnasium and mini restaurant was taken as  $5 \text{ kN/m}^2$ . Load factors for imposed loads were taken as half of the factors in BS8110:Part1:1985 Table 2.1 as stated in BS6399:Part1:1996 Table 2 for multi storey construction.

All the loads were applied as unit loads i.e. the UDL was taken as unit when applying the loads and then multiplied by the actual UDL as load combinations. This allows us to change the loads if needed and also we have to apply loads only once in case of both dead and imposed loads.

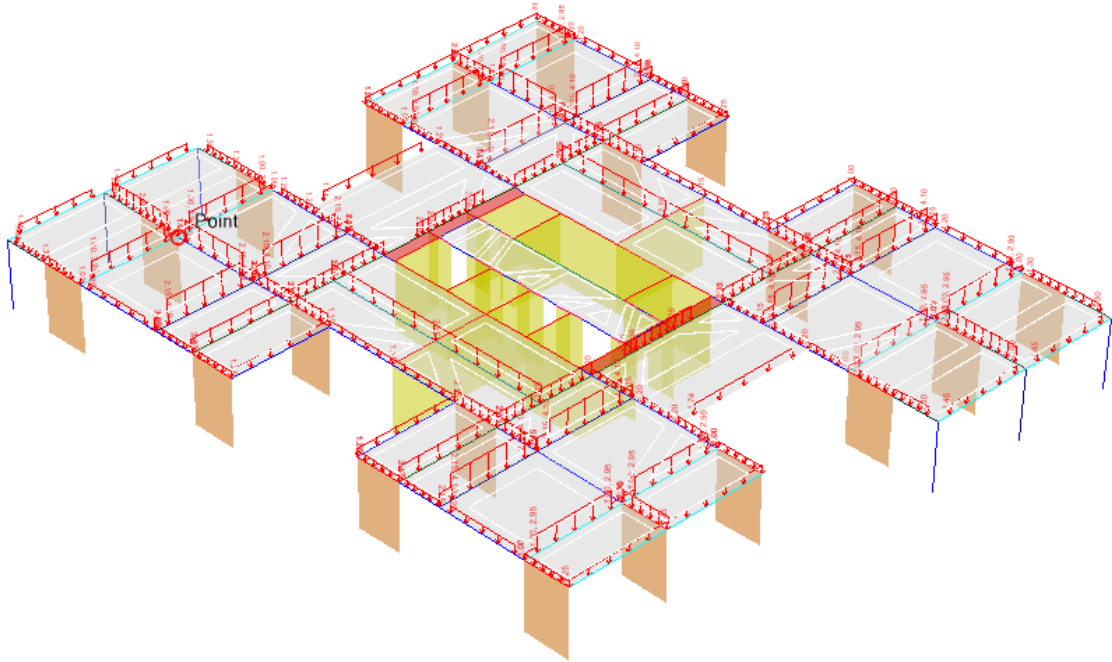

**Figure 7.4 - Application of unit loads in apartment floors**

**7.2.3. Wind load**

Wind load for this building was calculated using CP3 chapter 5 part II wind loads 1972 and then verified by AS NZS 1170.2- 2011. Wind load calculated using the latter was found out be less than the former. Therefore it is not necessary to calculate wind loads again using AS 1170.2- 2011. Calculations were shown in ANNEX 7. Wind load for the building was calculated as a distributed load first. Then the loads were multiplied by the area facing the wind and applied on nodes. For convenience wind loads were calculated by 5 floors taking as one.

S <sub>1</sub>	S <sub>2</sub>	S <sub>2</sub>	V <sub>s</sub> (m/s <sup>2</sup> )	q (N/m <sup>2</sup> )
1	1	0.94	31.49	608
1	1	1.01	33.835	702
1	1	1.05	35.175	758
1	1	1.08	36.18	802
1	1	1.11	37.185	848
1	1	1.13	37.855	878
1	1	1.15	38.525	910
1	1	1.17	39.195	942
1	1	1.19	39.865	974

**Table 7.4  
- Wind loads for each 5 floor levels**

<b>q (kN/m<sup>2</sup>)</b>	<b>W<sub>1</sub>(kN)</b>	<b>W<sub>2</sub>(kN)</b>	<b>W<sub>3</sub>(kN)</b>	<b>W<sub>4</sub>(kN)</b>
<b>Area (m<sup>2</sup>)</b>	4.5	17.64	18.54	9
<b>0.608</b>	2.736	10.725	11.272	5.472
<b>0.702</b>	3.159	12.383	13.015	6.318
<b>0.758</b>	3.411	13.371	14.053	6.822
<b>0.802</b>	3.609	14.147	14.869	7.218
<b>0.848</b>	3.816	14.959	15.722	7.632
<b>0.878</b>	3.951	15.488	16.278	7.902
<b>0.910</b>	4.095	16.052	16.871	8.190
<b>0.942</b>	4.239	16.617	17.465	8.478
<b>0.974</b>	4.383	17.181	18.058	8.766

**Table 7.5 - Wind loads on nodes in x direction**



University of Moratuwa, Sri Lanka.  
Electronic Theses & Dissertations  
[www.lib.mrt.ac.lk](http://www.lib.mrt.ac.lk)

<b>q (kN/m<sup>2</sup>)</b>	<b>W<sub>y1</sub>(kN)</b>	<b>W<sub>y2</sub>(kN)</b>	<b>W<sub>y3</sub>(kN)</b>
<b>Area (m<sup>2</sup>)</b>	9.9	19.8	24.12
<b>0.608</b>	6.019	12.038	14.665
<b>0.702</b>	6.950	13.900	16.932
<b>0.758</b>	7.504	15.008	18.283
<b>0.802</b>	7.940	15.880	19.344
<b>0.848</b>	8.395	16.790	20.454
<b>0.878</b>	8.692	17.384	21.177
<b>0.910</b>	9.009	18.018	21.949
<b>0.942</b>	9.326	18.652	22.721
<b>0.974</b>	9.643	19.285	23.493

**Table 7.6 - Wind loads on nodes in y direction**

### 7.3.2. Springs

In the substructure we have bored piles. To account for the soil interaction we assigned springs at every 1 metre on piles. First we divided the pile into 1m pieces and then assigned a spring on each node. Springs were calculated using the equation  $\text{spring} = 40 \times 2 \times \text{soil strength}$ .

Soil layer	Strength	Spring
Peat	100	8000
Sandy clay	200	16000
Weathered rock	250	20000

Table 7.7 - Spring values for piles

### 7.3.3. Seismic load

Seismic loads were calculated according to AS 1170.4-1993. Both dynamic and static analysis was done using SAP2000. Calculations are given in ANNEX 7.

#### Static analysis

Base shear = 3173 kN

Load distribution was given below

G <sub>bl</sub>	h <sub>i</sub>	G <sub>bl</sub> h <sub>i</sub> <sup>2</sup>	G <sub>bl</sub> h <sub>i</sub>	C <sub>vx</sub>	F <sub>x</sub>
7466	1.6	19112.96	19112.96	7.2209E-06	0.022912
7466	4.8	172016.64	172016.6	6.49881E-05	0.206207
7466	8	477824	477824	0.000180522	0.572798
7466	11.2	935550.4	935535	0.000353824	1.122684
7466	14.4	1548149.76	1548150	0.000584893	1.855865
7466	17.6	2312668.16	2312668	0.000873729	2.772341
6092	21.6	2842283.52	2842284	0.001073818	3.407224
6092	25.2	3868663.68	3868664	0.001461586	4.637611
6092	28.8	5052948.48	5052948	0.00190901	6.057288
6092	32.4	6395137.92	6395138	0.00241609	7.666255
6092	36	7895232	7895232	0.002982828	9.464512
6092	39.6	9553230.72	9553231	0.003609221	11.45206
6092	43.2	11369134.1	11369134	0.004295272	13.6289
6092	46.8	13342942.1	13342942	0.005040979	15.99503
6092	50.4	15474654.7	15474655	0.005846342	18.55044
6092	54	17764272	17764272	0.006711362	21.29515
6092	57.6	20211793.9	20211794	0.007636039	24.22915
6092	61.2	22817220.5	22817220	0.008620372	27.35244
6092	64.8	25580551.7	25580552	0.009664362	30.66502
6092	68.4	28501787.5	28501788	0.010768008	34.16689
6092	72	31580928	31580928	0.011931311	37.85805
6092	75.6	34817973.1	34817973	0.01315427	41.7385
6092	79.2	38212922.9	38212923	0.014436886	45.80824
6092	82.8	41765777.3	41765777	0.015779158	50.06727
6092	86.4	45476536.3	45476536	0.017181087	54.51559
6092	90	49345200	49345200	0.018642673	59.1532
6092	93.6	53371768.3	53371768	0.020163915	63.9801

6092	97.2	57556241.3	57556241	0.021744814	68.99629
6092	100.8	61898618.9	61898619	0.023385369	74.20178
6092	104.4	66398901.1	66398901	0.025085581	79.59655
6092	108	71057088	71057088	0.026845449	85.18061
6092	111.6	75873179.5	75873180	0.028664974	90.95396
6092	115.2	80847175.7	80847176	0.030544155	96.9166
6092	118.8	85979076.5	85979076	0.032482993	103.0685
6092	122.4	91268881.9	91268882	0.034481488	109.4098
6092	126	96716592	96716592	0.036539639	115.9403
6092	129.6	102322207	1.02E+08	0.038657447	122.6601
6092	133.2	108085726	1.08E+08	0.040834911	129.5692
6092	136.8	114007150	1.14E+08	0.043072031	136.6676
6092	140.4	120086479	1.2E+08	0.045368809	143.9552
6092	144	126323712	1.26E+08	0.047725243	151.4322
6092	147.6	132718850	1.33E+08	0.050141333	159.0984
6092	151.2	139271892	1.39E+08	0.05261708	166.954
6092	154.8	145982840	1.46E+08	0.055152484	174.9988
6092	158.4	152851692	1.53E+08	0.057747544	183.233
6092	162	159878448	1.6E+08	0.06040226	191.6564
6092	165.6	167063109	1.67E+08	0.063116633	200.2691
	SUM	2646895124		SUM	3173

**Table 7.8 - Seismic load distribution in each floor - static analysis**

### Dynamic analysis

Dynamic analysis was done using response spectrum function in SAP2000.

Acceleration for each period was found according to AS 1170.4-1993 Figure 7.2.

Maximum drift at top = 108 mm

Drift index = 0.07%

Total base shear = 3233 kN

### 7.3. Dynamic behavior of the building

Dynamic behaviour of the building was found using SAP2000 analysis. Only the mass of structural elements was used as mass source for dynamic behaviour.

Mode	Period	Frequency
Sway –along longer direction	6.28	0.16
Sway –along shorter direction	5.84	0.17
Torsional	3.48	0.29

**Table 7.9 - Fundamental period in three aspects**

Torsional response was much lower than sway response. Thus the building will have a sway mechanism and avoid extra moments in members.

### 7.4. Outputs and Validation of the Model

SAP model was used to take forces on walls and columns. Therefore the major output of the model is axial forces on walls and columns. We further got the axial forces on piles and shear forces on pile cap using SAP2000 model. Drift and settlement at ground floor level was also got from SAP analysis.

### 7.4.1. Axial forces

Axial forces for walls and columns were the main output we took from SAP2000 model for designing.

We used axial forces to validate the model also. We compared the approximately calculated axial forces with SAP2000 results.

Manually calculated axial load (kN)	SAP2000 result (kN)
4907.3	7600
5949.3	8200
4168.1	7700
1962.9	1531
3394.9	2850
16759.2	14000
21544.7	22000
20420.7	13750
21425.0	18000
20418.7	21000
17464.5	9900
1957.0	2267
2279.2	1550
3925.9	3280
15578.1	17500
20999.9	20000
21409.3	20000
15598.1	20000
2285.1	2762

It can be seen that the values from each method do not differ very much. When the difference is much larger SAP result is always larger. Therefore we used SAP2000 results for design calculations.

### 7.4.2. Sub structure

Loads on piles were taken from geotechnical calculations. The main objective in this analysis was to find bending moments pile caps and settlement at the ground level.



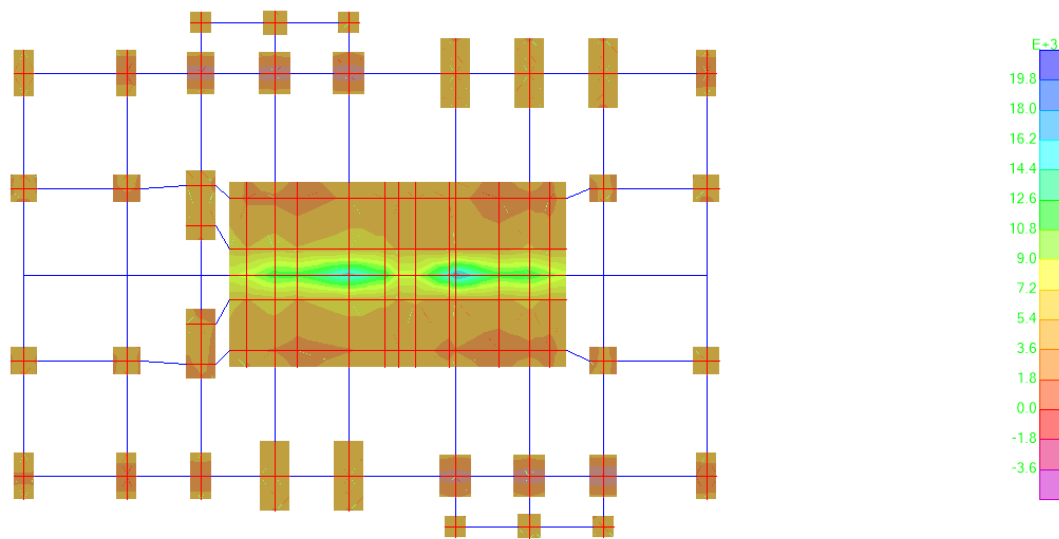

Figure 7.5 - bending moment in pile caps

### 7.3.4. Other results

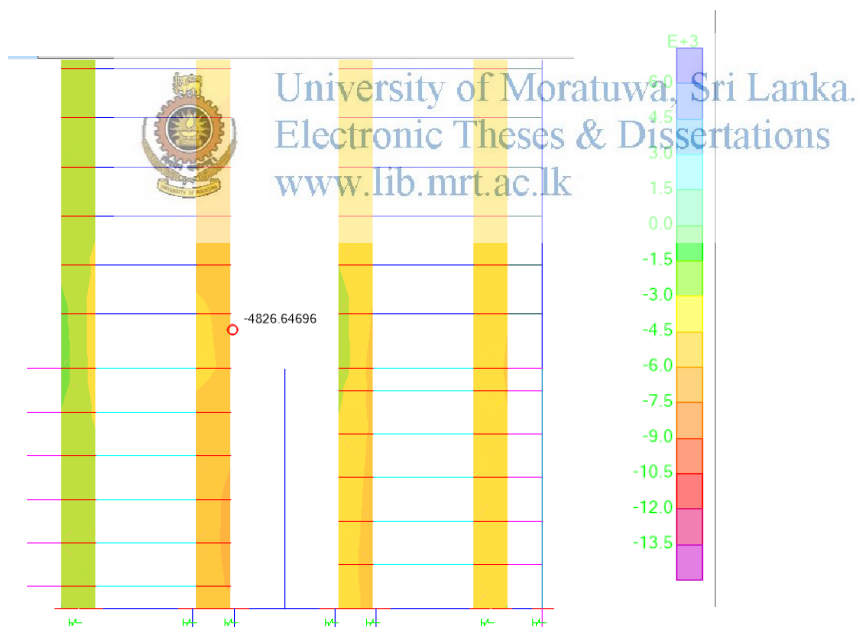
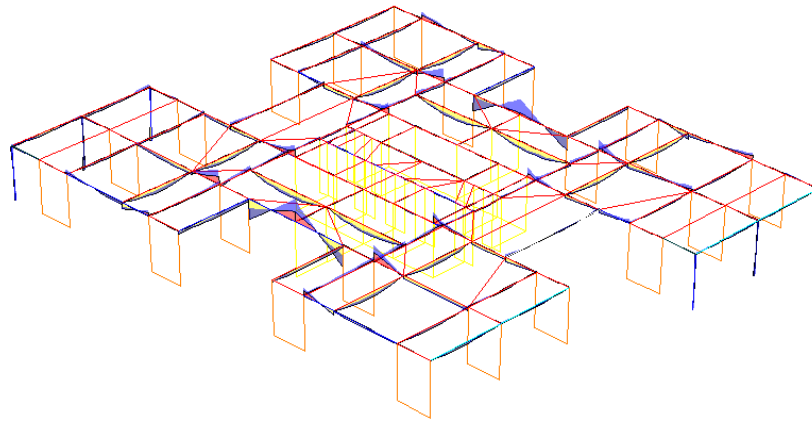

Figure 7.6 - Axial force on walls



**Figure 7.7 - Bending moment diagrams of an apartment floor**

## 7.5. Lateral stability of the structure

### 7.5.1. Cross wind response

The cross wind response is illustrated in clause 6.3 of AS 1170.2-1989. Cross wind acceleration (Force) depends on Cross wind spectrum coefficient ( $C_{fs}$ ). This coefficient defined using the reduced velocity ( $V_n = \frac{V_{des}}{n_c b [1 + g_v I_n]}$ ) but  $C_{fs}$  is available for  $2 < V_n < 16$ . The calculated value of reduced velocity for this building is 1.3. It means in case of wind loading this building is not a slender structure so effect of cross wind acceleration (Force) cannot give high disaster. However the research conducted by M.T.R. Jayasinghe et al. (ICSBE-2010) shows higher cross wind acceleration than along wind acceleration for a building which is slender in case of wind loading. So this report recommends to seeking additional data or wind tunnel test to better prediction of cross wind forces.

### 7.5.2. Along wind response

The along wind acceleration at the top of building was calculated using AS 1170.2-1989. Wind load was taken as 38m/s.

$$\begin{aligned} \text{Along wind acceleration} &= [2 \pi n_a]^2 g_f r \sqrt{\frac{SE}{\xi}} \Delta \\ &= 0.12 \text{ ms}^{-2} \end{aligned}$$

The value is lesser than thrust hold value of 0.15 so we are in the safe side.

## 7.6. Drift calculation

Drift was calculated as it is required by AS 1170.4-1993.

	Static method	Dynamic method
<b>Deflection at the top</b>	128mm	108mm
<b>Maximum storey drift</b>	11mm	9.45mm
<b>Maximum storey drift index</b>	0.31%	0.26%

In both static and dynamic methods drift index is lesser than 1%. Therefore do not need to take P-Delta effect into account.



University of Moratuwa, Sri Lanka.  
Electronic Theses & Dissertations  
[www.lib.mrt.ac.lk](http://www.lib.mrt.ac.lk)

## 8. DESIGN OF THE SUPERSTRUCTURE

### 8.1. Introduction to structural system

Basically selection of structural systems runs through 3 different phases;

1. Conceptual design phase
2. Preliminary design phase
3. Detailed design phase

#### 8.1.1. Conceptual Design Phase

Conceptual design deals with selecting overall possible systems and their configurations. It is suggested that nearly 80% of the structural cost is associated with this stage. Detail analysis has been carried out in the following topics to select a suitable system.

The selection of a structural system for a high- rise building depends on many factors; the main factors which were considered when deciding a structural system are listed below.

- Building cost
- Aesthetic appearance
- Height of the building
- Available utility area
- Load transferring pattern
  - Transfer of vertical and gravity loads
  - Transfer of lateral loads
- Incorporation of sustainability concepts

Even though no procedural oriented guidelines are available to select a structural system, analyzing alternative systems in the context of the building by considering the above factors would be a prudent approach to select a structural system. After considering the above factors in depth and analyzing the alternate structural systems, the most stable arrangement for this building was selected as a wall structure, where the shear walls will be the lateral load resisting elements.

### 8.1.2. Load transfer mechanism

Vertical loads are mainly carried by columns and lateral loads are carried by shear walls. Generally the shear walls in a building should be preferably distributed through the structure and arranged so that their combined shear centre was located approximately on the line of the resultant in plan of the applied overturning forces.

### 8.1.3. Structural arrangement

Structural arrangement is arranged by locating structural elements according to the architectural drawings, while considering architectural aspects. That was a difficult task mainly due to the long span of beams and huge columns

### 8.1.4. Effect of Relative Strength of Beams and Columns

The modern trend in buildings is to maximize the spans while minimizing the number of columns. This would necessitate beams of considerable depth where the column sizes are kept relatively small. In the event of an earthquake, the strong beams remain elastic while the weak columns suffer concrete crushing or shear failure, which may lead to the collapse of the building. That is the plastic hinge will form in column not at the beam in beam-column junction.

When long beams are unavoidable, it may be appropriate to use larger columns than required by axial loads and moments. The same concept is used in this building. It can be seen by looking at capacity of each column compared with its required capacity. Larger columns with suitable earthquake resistant details will have a much higher chance of survival than smaller columns

## 8.2. Preliminary Design

### 8.2.1. Introduction

Member sizes for the selected structural arrangements were calculated based on the deflection criteria for slabs and beams, strength criteria for columns using the Manual for the Design of Reinforced Concrete Building Structures published by the Institution of Structural Engineers- UK.

## 8.2.2. Criteria used for member size selection

### Beams

Span/effective depth ratio was used to select the beam depth as well as the thumb rule of one inch depth per one feet span length was considered. Sample calculation is given below.

Beam span = 7.3 m = 24'

Beam depth = 24" = 600 mm

**Table 8.1: Span/effective depth ratios for initial design of beams**

Cantilever	6
Simply supported	12
Continuous	15

For a continuous beam of 7.3 m span, effective depth =  $7300/15 = 487$  mm

Beam depth =  $d + \text{cover} + \text{link diameter} + \text{main bar dia.}/2$

$$= 487 + 25 + 10 + 20/2 = 532 \text{ mm}$$

Hence 600 mm was used as the initial beam depth.

Beam width was selected as 225 mm.

### Slabs



University of Moratuwa, Sri Lanka.

Electronic Theses & Dissertations

www.lib.mrt.ac.lk

Span/effective depth ratio was used to select the slab thicknesses. Table 8.2 shows the used values.

**Table 8.2: Span/effective depth ratios for initial design of slabs**

Characteristic imposed loading (including finishes) (kN/m <sup>2</sup> )	One-way spanning			Two-way spanning		Flat slabs without drops
	Simply supported	Continuous	Cantilever	Simply supported	Continuous	
5	27	31	11	30	40	36
10	24	28	10	28	39	33

Sample calculation is given below.

Two-way spanning continuous slab, with short span length of 5.5 m;

Effective depth =  $5500/40 = 137.5$  mm

Slab thickness =  $137.5 + 25 = 162.5$  mm

Hence selected slab thickness as 150 mm

## Column

Column sizes were selected based on the approximate load per column, calculated considering the tributary area and reinforce percentage intended to be used.

## 8.3. Detail Design

### 8.3.1. Slab design

This building is an apartment building consists of 5 parking floors and 40 apartment floors. All of apartment floors have same lay out and all car park floors have the same layout.

#### Apartment floor slab design

Each apartment floor has four apartments. Four slab panels used in slab design are given below in Figure 8.1.

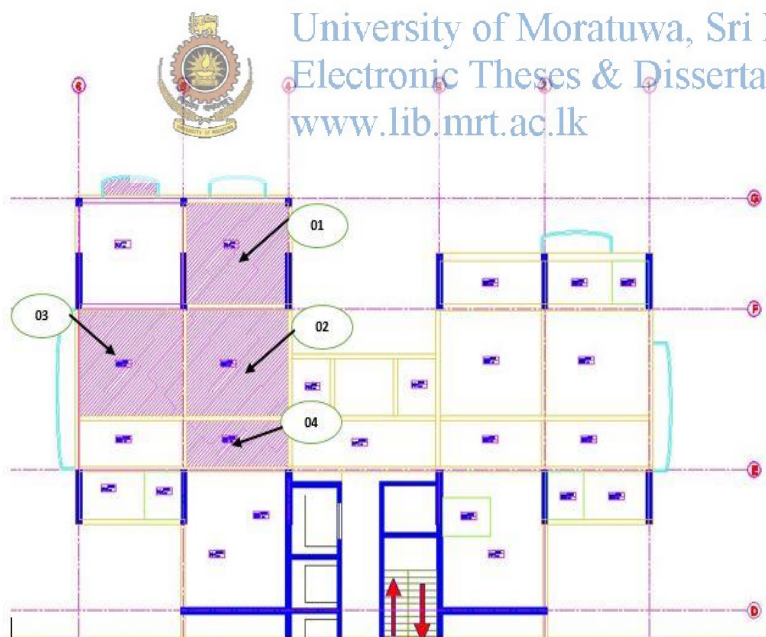

Figure 8.1: Apartment floor slab panels

Basic details and design loads used are given below.

Concrete grade -35  
 Slab thickness 150mm  
 Cover 25mm  
 Unit weight of concrete 24 N/mm<sup>2</sup>  
 Unit weight of brick wall 20 kN/m<sup>2</sup>

All

Dead load

Self-weight of slab	24 x 0.15	=	3.6
Finishes		=	0.75
Services		=	0.5
	$g_k$	=	4.85 kN/m <sup>2</sup>

Impose load	$q_k$	=	1.5 kN/m <sup>2</sup>
-------------	-------	---	-----------------------

Detailed design calculations are given in **Annex 8.1a**

Slab panel 1, 2 and 3 – two way spanning

T10@200 for all direction



University of Moratuwa, Sri Lanka.  
 Electronic Theses & Dissertations

Slab panel 4 – one way spanning

Bottom r/f = T10@200 in span and near support  
 Top r/f = T10@300

Cantilever

T10@150 over support

Car park floor slab design

Selected slab panels for design is given in Figure 8.2. Following loads were considered and detail design calculations are given in **Annex 8.1b**

Self-weight of slab	= 0.15 x 1 x 24
	= 3.6 kN/m
Weight of finishes	= 0.75 kN/m
Imposed load	= 2.5 kN/m



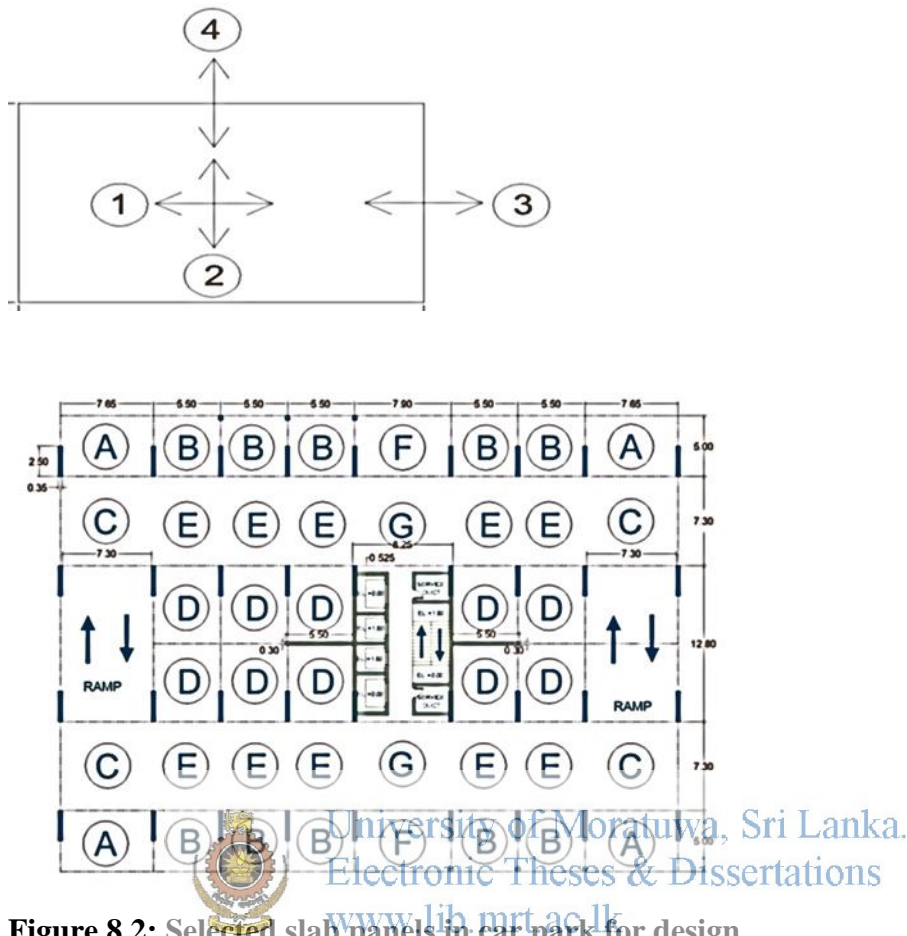

Figure 8.2: Selected slab panels in car park for design

Table 8.3 gives the provided reinforcement at the locations given in Figure 8.3.

Figure 8.3: Considered locations for provide reinforcement

Table 8.3: Provided reinforcement for each slab panel

Slab panel	1	2	3	4
A	T10@250	T10@250	T10@200	T10@200
B	T10@250	T10@200	T10@250	T10@200
C	T10@250	T10@250	T10@250	T10@250
D	T10@250	T10@250	T10@200	T10@250
E	T10@250	T10@250	T10@200	T10@250
F	T10@250	T10@200	T10@250	T10@200
G	T10@200	T10@200	T10@200	T10@200

### 8.3.2. Stair Case Design

Following loadings were used in staircase design.

$$\text{Dead Load} = 25 * 0.175 = 4.375 \text{ kN/m}^2$$

$$\text{Finishes} = 0.75 \text{ kN/m}^2$$

$$\text{Impose Load} = 4.0 \text{ kN/m}^2$$

$$\text{Partition} = 1 \text{ kN/m}^2$$

$$\text{Plastering} = 0.25 \text{ kN/m}^2$$

For the landing slab reinforcement was calculated as follows and detail design calculation is given in **Annex 8.2**.

R/f in all directions T10@ 400 mm spacing

For the flight design following parameters were used.

$$\text{Rise} = 150 \text{ mm}$$

$$\text{Going} = 300 \text{ mm}$$

$$\text{Steps per flight} = 9$$

$$\text{Floor to floor height} = 3.6 \text{ m}$$

For main steel: Use 8T12 @ 200 mm spacing

For distribution steel: R8@150 mm spacing



University of Moratuwa, Sri Lanka.

Electronic Theses & Dissertations

**8.3.3. Beam Design** [www.lib.mrt.ac.lk](http://www.lib.mrt.ac.lk)

Loads acting on beams were taken, considering shear force coefficients given in Table 3.16, BS 8110. Bending moments and shear forces were taken from sub frame analysis carried out using Prokon. Detail design calculation and results of Prokon analysis are given in **Annex 8.3**.

### 8.3.4. Column Design

Columns were idealized as shell thin elements in SAP 2000 model. The columns have to be designed as walls due to high length to thickness ratio. Axial loads per unit length & out of plane bending moments were taken from SAP model for ultimate combinations by dead, live, earthquake and wind load combinations. The out of plane bending was always lower than the moment created by minimum eccentricity of 0.05 times the overall thickness of the column in the plane of bending considered but not more than 20 mm. Columns were detailed considering the earthquake detailing aspects as well. Detail design calculations are given in Annex 8.4.

### 8.3.5. Shear Wall Design

Shear walls were idealized as membrane elements in SAP 2000 model. Axial loads on shear walls were taken from SAP model. Designed as a wall according to BS 8110 considering minimum eccentricity as 0.05 times the overall dimension of the column

in the plane of bending considered but not more than 20 mm. Shear walls were detailed considering the earthquake detailing aspects as well. Detail design calculations are given in **Annex 8.5**.

### 8.3.6. Coupling Beam Design

Coupling beams in shear walls often short and relatively deep and subjected to high shearing stress when the ultimate flexural strength is to be developed. In deep spandrel beams, these shear forces not only inhibit the full development of the flexural capacity, they also restrict the ductility obtainable. The behaviour of the some coupled shear walls that were exposed to severe earthquakes indicated that all or most coupling beams failed before the ultimate of the coupled walls was attained. It is possible, however, that in some structures the ultimate strength of the walls will be exhausted before plastic hinges form in the coupling beams.

#### Calculation of the amount of reinforcement in coupling Beams

Width (B) = 300 mm  
 Depth (H) = 1800 mm  
 Length (L) = 3m  
 Cover (d') = 40 mm

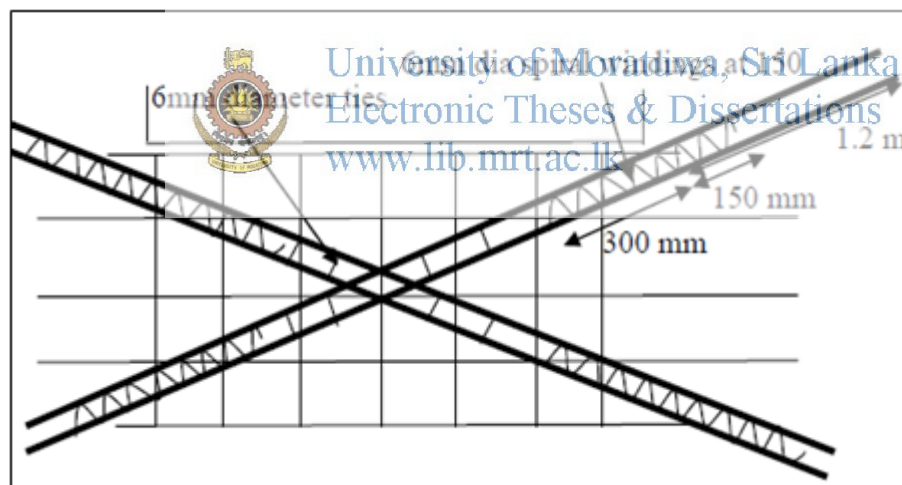

**Figure 8.4: Coupling beam**

$$\tan \alpha = (1800 - 40 \times 2) / 3000 = 0.57$$

$$\alpha = 29.82^\circ$$

$$A_s = V_u / 2 \times 0.87 \times f_y \sin \alpha$$

$$V_u = 363 \text{ kN}$$

$$f_y = 460 \text{ N/mm}^2$$

$$A_s = 912 \text{ mm}^2$$

So provide 4 T20 bars. Bar arrangement and the spiral winding is shown in the Figure 8.4. Provide 6 mm diameter spiral winding.

### 8.3.7. Swimming pool Design

Two swimming pools are located at either sides of the recreational floor. It is 7.3 m wide and 25.1 m long. Swimming pool, roof top water tank and water sump located at ground floor are the water retaining structures designed in this building. British Standard BS 8007:1987 was used for the design calculations of all water retaining structures.

Following material properties were used in design calculation of all three water retaining structures.

Density of water = 9.8 kN/m

Density of concrete = 24 kN/m

$f_{cu} = 35 \text{ N/mm}^2$

$f_y = 460 \text{ N/mm}^2$

Swimming pool is consisted of three sections. Deep end, shallow end and a sloping section in between.

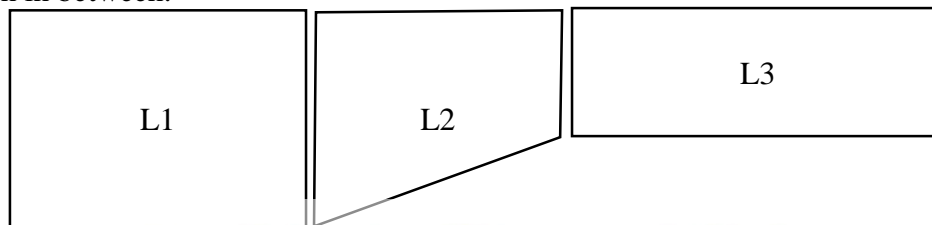

University of Moratuwa, Sri Lanka  
Electronic Theses & Dissertations  
www.lib.mrt.ac.lk

Reinforcement requirement is given below. Detailed design calculations are given in Annex 8.7

#### Long wall (Vertical)

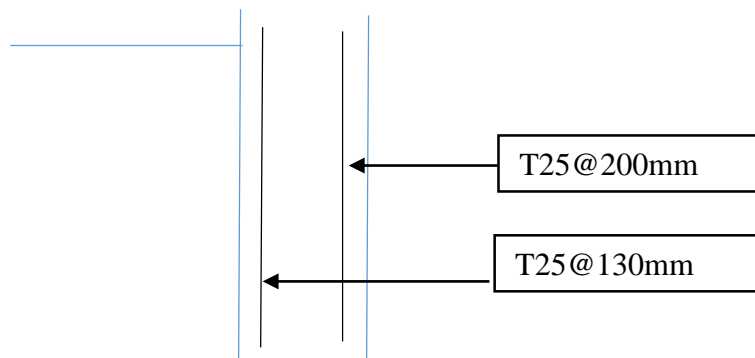

**Figure 8.6: Long wall vertical reinforcement**

T25@130mm R/f provided=  $3776 \text{ mm}^2/\text{m}$

T25@200mm R/f provided=  $2454 \text{ mm}^2/\text{m}$

#### Long wall (Horizontal)

T12@ 200mm both sides =  $565 \text{ mm}^2/\text{m}$

**Short wall (Vertical)**

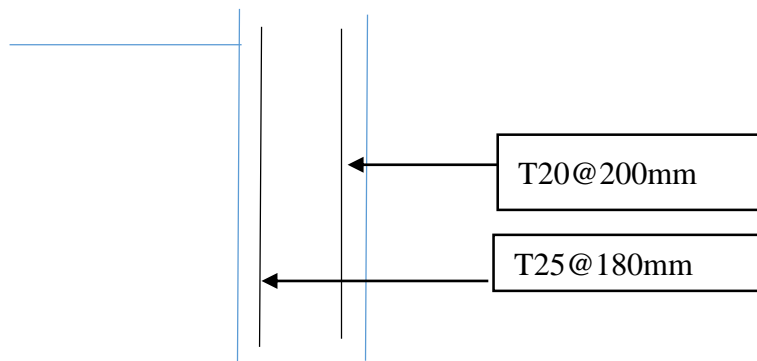

**Figure 8.7: Short wall vertical reinforcement**

T25@180mm R/f provided= 2727mm<sup>2</sup>/m

T20@200mm R/f provided= 1570mm<sup>2</sup>/m

**Long wall (Horizontal)**

T12@ 200mm both sides = 565mm<sup>2</sup>/m



University of Moratuwa, Sri Lanka.  
Electronic Theses & Dissertations  
www.lib.mrt.ac.lk

**R/f provided for the Bottom Slab**

At Support along short span: T25 @ 130mm = 3775mm<sup>2</sup>/m (Top)

At support along long span: T25 @ 150mm = 3272 mm<sup>2</sup>/m (Top)

At span along short span: T12 @ 130mm = 870mm<sup>2</sup>/m (Bottom)

At span along long span: T12 @ 130 mm = 870mm<sup>2</sup>/m (Bottom)

Support Bottom long and short span: T12 @150mm

At Span top short and long span way: T12 @150mm

**8.3.8. Water sump Design**

Water sump at the ground floor level (internal dimensions 12.8m x 7.3m x 1.6m).

Used a minimum thickness of 200 mm for walls and floor slab and 100mm for the top slab. Same design parameters mentioned in 8.3.7 were used.

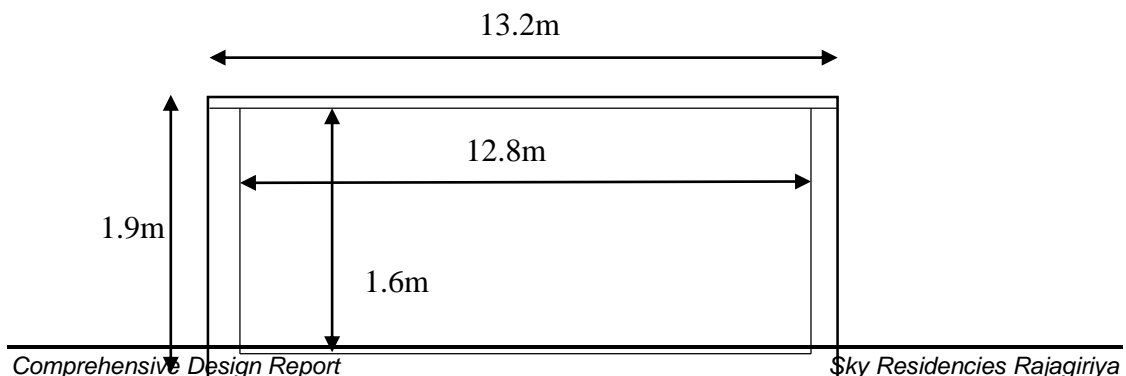

**Figure 8.8: Dimensions of long wall in water sump**

Design calculations were carried out according to the British Standard BS 8007:1987 and reinforcement requirement was found as follows. Detail design calculations are given in **Annex 8.8**.

Reinforcement for both **short and long walls** are equal.

**Vertical r/f** = maximum of  $213\text{mm}^2$ ,  $350\text{mm}^2$ ,  $400\text{mm}^2$  and  $414\text{mm}^2$   
Hence provide T12@200mm ( $565\text{mm}^2$ )

**Horizontal r/f** = maximum of  $350\text{mm}^2$ ,  $400\text{mm}^2$  and  $260\text{mm}^2$   
Hence provide T12@200mm ( $565\text{mm}^2$ )

Reinforcement requirement for the **base slab** is given below.

**Short span r/f** requirement =  $1669\text{mm}^2$   
Hence provide T20@180mm ( $1740\text{mm}^2$ )

**Long span r/f** requirement =  $1000\text{mm}^2$   
Hence provide T16@200mm ( $1005\text{mm}^2$ )



University of Moratuwa, Sri Lanka.  
Electronic Theses & Dissertations  
[www.lib.mrt.ac.lk](http://www.lib.mrt.ac.lk)

## 8.4. Disaster Resistive Design

The concept of disaster resistive design impacts almost all the stages involved in the design process. It affects the conceptual, preliminary and detail design. This design considered two disaster aspects; fire resistance and earth quake. The other possible disastrous activity such as blasting and tsunami was not considered due to the low probability of its impacts

### 8.4.1. Fire Resistance

The safeguard measures against the fire have been provided by complying with the requirement specified in the BS 8110. The selection of cover thickness and selecting the member size sufficient thickness has been the practice to mitigate fire resistance. This selection criterion ensures that the critical members have been offered with high hours of fire resistance than non-critical members. This leads towards progressive failure, which is considered on of the important aspect in building design.

**Table 8.4: Fire resistance of structural members**

Structural Members	Hours of fire Resistance
Beams	2
Slabs	2
Columns	4
Shear Walls	4

### 8.4.2. Earthquake Resistance

This is one of the important and critical aspects than fire resistance. The main criteria of designing a building to resist an earthquake (Hutchinson et al, 1995) is that the building should be able to resist,

- minor earthquakes without damage
  - moderate earthquakes without structural damage but with some non-structural damage
  - major earthquakes without collapse, but with some structural and non-structural damage
- Its concepts affect the following areas, which run through the whole design process

1. Structural Form
2. Member Sizing
3. Analysis
4. Detailing

### 8.4.3. Structural Form

Regular structures of simple shapes have a higher possibility of survival than an irregular structure at an earthquake. L or T shape structures are considered irregular structure. The arrangement of this building also the conventional rectangular structure, but its shape is regular structure. So, by having proper shape in the very first stage of the design, earthquake resistance is controlled

#### 8.4.4. Effects of Eccentric Cores

Where the shear center doesn't align with mass center, it can be subjected to torsion. This may not be a preferred option in case of earthquake. To prevent this, building has been design to have its shear center in the middle.

#### 8.4.5. Effect of Soft Zoning

Soft zoning occurs, where the bottom stories stiffness has lesser value than the stories above it. During the earthquake, both will vibrate in different frequency, which can be detrimental to the structure. This stiffness difference has been omitted in this proposed building to ensure earthquake resistance.

#### 8.4.6. Effect of Relative Strength of Beams and Columns

The modern trend in buildings is to maximize the spans while minimizing the number of columns. This would necessitate beams of considerable depth where the column sizes are kept relatively small. In the event of an earthquake, the strong beams remain elastic while the weak columns suffer concrete crushing or shear failure, which may lead to the collapse of the building.



University of Moratuwa, Sri Lanka  
Electronic Theses & Dissertations  
[www.lib.mrt.ac.lk](http://www.lib.mrt.ac.lk)

When long beams are unavoidable, it may be appropriate to use larger columns than required by axial loads and moments. The same concept is used in this building as well in the basement car park. It can be seen by looking at capacity of each column compared with its required capacity. Larger columns with suitable earthquake resistant details will have a much higher chance of survival than smaller columns.

#### 8.4.7. Member Sizing

Earthquake resistance design requires minimum member thickness for each structural members to mitigate earthquake impacts. This thickness requires commonly higher than that of fire resistance. So, the consideration of member thickness in the view of earthquake is only enough (fire resistance thickness is not needed).

#### 8.4.8. Analysis

The earthquake resistance design requires a lateral load to be applied to the building. Its significance can be observed by comparing with the wind load. The following table



shows the comparison. By looking at it, it's apparent that the earthquake induces huge load. Normally for vertical vibration, building has the resistance.

### 8.4.9. Detailing

Due to the cyclic nature of the loading during an earthquake, beam column junctions will be subjected to extra shear forces and tensile stresses that may not exist with static loads. Therefore, beam column junction also needs extra precautions in detailing to prevent crushing failure of concrete

A reasonable approach for mitigating the seismic effects by proper reinforcement details at joints and connections, which enhance the ductility at such locations, is summarized in this section.

Following guidelines can be generally followed in selecting member dimensions and reinforcement detailing to mitigate seismic effects by enhancing the ductility of the structure at the event of an earthquake.

### 8.4.10. Structural detailing with disaster resistant detailing

Earthquakes and Cyclones are the major disasters considered in disaster resistant detailing since they exert forces with high magnitude in a short period of time. By designing the structure to resist this type of disasters will keep the structure undamaged in that kind of situations. If the structure can withstand that small time duration, there will not be any life or economic losses. Since earthquakes and cyclones are very rare in Sri Lanka many people neglect their impact and eliminate disaster resisting detailing. Also there is a misunderstanding that disaster resistant detailing will cost huge amount of money. But with the recent volcanic activities and climatic changes, Sri Lanka is no longer a safe place from natural disasters. In order to ensure the lives and the economic value of the proposed building, disaster resistant detailing is included with the structural detailing. Three major criteria are used for disaster resistant detailing,

1. Confinement reinforcement at shear wall edges.
2. Confinement reinforcement at beam column junction.
3. Special detailing procedure for coupling beams.

Shear wall edges tend to have more energy dissipation than in the middle part of the wall in an earthquake or high wind situation. While dissipating energy wall edge cracks and crack propagates to the middle parts of the wall. Whole structure can fail due to the propagation of cracks. Not only shear wall edges, beam column junctions is also a

critical place considering the energy dissipation and the stability of the structure. In order to confine the beam column junction, shear links that were in the column is continues even through the beam depth but not with the same spacing, limiting the number of links to three. In order to ensure the stability of the shear walls coupling beams were introduced to the structure. There are two coupling beams in the structure per floor. Special attention was given to earth quake and disaster resisting detailing. Some of special points considered are mentioned below.

### Columns

Identify two zones called confinement and intermediate zones. And provided more shear links to confinement zone because joints failure more than easier.

Confinement zone (L1), largest of

- $L_0/5$  ( $L_0$ =column height)
- 450mm
- H (length)

Diameter of supplementary ties to be same diameter as links

All laps to be confined by minimum of 3 links. Top most link to be at top of lower splice bar

Laps should be made at mid column height



University of Moratuwa, Sri Lanka.  
Electronic Theses & Dissertations  
[www.lib.mrt.ac.lk](http://www.lib.mrt.ac.lk)

### Beams

No laps in top & bottom to occur within a distance of  $2 \times$  beam depth from the face of support

Laps are to be kept to a minimum

A minimum of  $\frac{1}{4}$  of the larger amount of top steel required at either end must continue for the whole length of the span

If  $h > 750\text{mm}$  ( $h$ = beam depth) provide extra longitudinal bars for  $\frac{2}{3}$  of the beam depth from the tension face with spacing  $< 250\text{mm}$

The area of a bottom steel provided at the supports must equal at least half the area of the top steel at that section

## 9. SUBSTRUCTURE DESIGN

Investigation of the site is a very important step in any geotechnical engineering project. The following major steps can be identified in a site investigation program.

- Literature survey
- Site visit
- Subsurface investigation program and sampling

### 9.1. Literature Survey

The very first step in a site investigation program is to obtain published information relevant to the project. Subsurface information can be obtained from Aerial Photographs. Google earth now provides aerial maps for many parts of the world. Aerial photographs can give information that is easily missed by borings. For example, a dark patch in the site could be organic material, or a different colour stripe going through the site could be an old streambed. We got the information from the Google earth about adjacent land uses and nearby structures and rivers or channels.

### 9.2. Site Visit

After conducting a literature survey, it is a good idea to pay a site visit. The following information was gathered during a site visit.

- Water level in nearby canal gave information regarding the groundwater condition in the area. It was around 1.5m depth.
- Adjacent side buildings are too close and there are many residential houses around the site, so it should consider at the initial stage of design and when pile driving could be a problem due to noise.
- There are no overhead obstructions such as power lines.

### 9.3. Subsurface Investigation

Field investigation consisted of advancing thirteen boreholes at the location marked as BH-01, to BH-13. The boreholes were advanced with a rotary- drilling machine. The drilling was carried out with overburden cutting tools and adopting the wash boring process to remove the cuttings from the bottom of the hole.

Standard Penetration Test (SPT) was carried out in regular intervals in the overburden. This test was carried out as specified in BS 1377.

#### Borehole locations

Thirteen boreholes were advanced in this site to get the idea of how subsurface soil layers are stratified and arranged, since this building is having 47 stories identification of the behaviour of the sub soil layers is important.

#### Subsurface soil layer between the BH-11 and BH-10

Subsurface soil layers were drawn according to the boreholes details. Then expected subsurface soil layers were drawn by taking average of each layer between these two boreholes. Expected subsurface soil layer thicknesses were used in plaxis model.

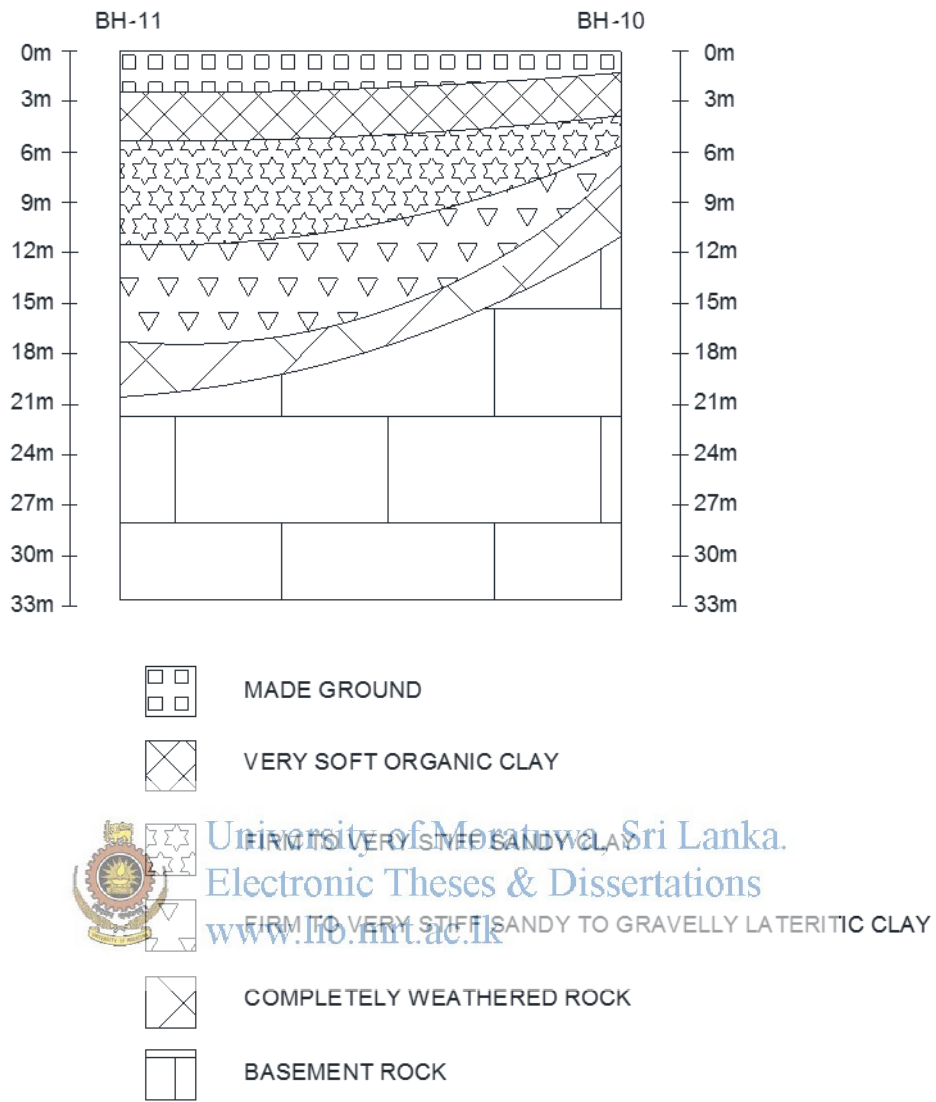

**Figure 9.1 Actual Subsurface profile**

**Expected subsurface soil layer between the BH-11 and BH-10**

Subsurface soil layers were drawn according to the boreholes details. Then expected subsurface soil layers were drawn by taking average of each layer between these four boreholes. Expected subsurface soil layer thicknesses were used in plaxis model.

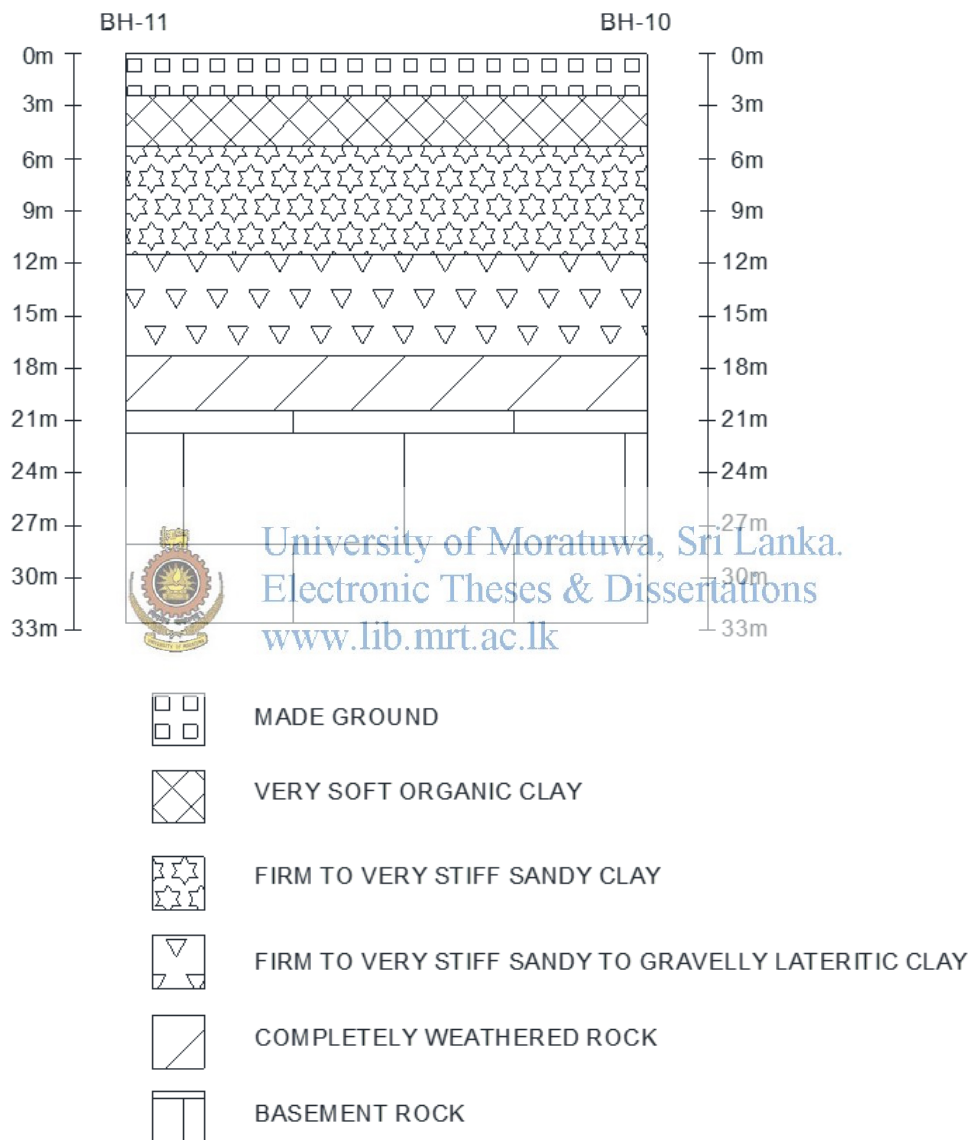

**Figure 9.2 Idealized sub surface profile**

**9.4. Estimation of soil strength parameters**

In this project there are thirteen bore holes that have been advanced. For that bore holes for different soil strata SPT test has been conducted and from the SPT, n value, using ENERGY CORRECTION METHOD soil parameters (cohesion and friction angle) have been calculated.

### 9.4.1. Specimen Calculation-Energy Approach Method (Borehole location1)

At a depth of 1.05m, soil type -unconsolidated fill

SPT value in the field=5

From energy method

$$N_{70} = CN \times N_{\text{Field}} \times \eta_1 \times \eta_2 \times \eta_3 \times \eta_4$$

$$CN - \text{Over burden correction} = (95.76/P'_{\text{o}})^{1/2}$$

$$P'_{\text{o}} = 0.8 \times 15 + (1.05 - 0.8) \times (15.5 - 9.81)$$

$$P'_{\text{o}} = 13.42 \text{ kNm}^{-2}$$

$$CN = (95.76/68.35)^{1/2}$$

$$CN = 2.67$$

$\eta_1$  - Energy correction factor

$$\eta_1 = E_r / 70 \text{ (assume Energy ratio of the SPT set up used is 80\%)}$$

$$\eta_1 = 80 / 70 = 1.14$$

$\eta_2$  = Rod length correction factor

$$\text{Rod length} = 1.05 + 1.5 \text{ m} = 2.55 \text{ m}$$

$$\eta_2 = 0.75$$

$\eta_3$  - Sample correction factor, due to sample is non linear

$$\eta_3 = 1.00$$

$\eta_4$  = Borehole diameter correction factor

Diameter of borehole is 75mm

$$\eta_4 = 1.00$$

$$N_{70} = CN \times N_{\text{field}} \times \eta_1 \times \eta_2 \times \eta_3 \times \eta_4$$

$$N_{70} = 2.67 \times 5 \times 1.14 \times 0.75 \times 1 \times 1$$

$$N_{70} = 11, \text{ therefore } \Phi = 32 \text{ and } C = 0$$

Similarly soil strength parameter calculations have done for all 13 boreholes. Results are given in the table.

BH - 13	depth to wt	top	bottom	Depth	Effective Pressure	SPT	CN	u1	u2	u3	u4	N70	FY	C			
	0.5	0	2.7	1.35	12.3365	6	2.786096	1.14	0.75	1	1	14	33	0		made ground (dry)	15
		2.7	5.8	4.25	31.9375	0	1.731576	1.14	0.85	1	1	0	0	12.5			
		5.8	9	7.4	52.961	22	1.344665	1.14	0.95	1	1	32	38	0		made ground (wet)	15.5
		9	21	15	99.205	25	0.982484	1.14	1	1	1	28	37	0			
																very soft organic clay	17.5
																soft sandy clay	15.5
																completely weathered rock	16



University of Moratuwa, Sri Lanka.

Electronic Theses & Dissertations

www.lib.mrt.ac.lk

Table 9. Selection of soil parameters for design

Select soil parameters in adverse condition

- Select minimum cohesion and friction angle values  
Friction angle = 28  
Cohesion = 12.5 KN/m<sup>2</sup>

### 9.4.2. Settlement of the piles

Settlement of the foundation is a critical parameter for the construction of any structure. Therefore the settlement of the piles is a very important factor for high rise buildings. For the calculation of the settlement of an end bearing pile the method used is introduced by Poulos and Davis (1996).

$$\rho = \frac{P I}{E D}$$

$\rho$  = Settlement

P = applied axial force

E=Elastic modulus of the surrounding material along the pile shaft

D= Diameter of the pile

I= settlement Influence factor

**Table 9.2 Assumed E and v values**

Soil Layer Type	E ( Mpa)	Poisson Ratio (v)
made ground	10	0.2
clay	15	0.3
sandy clay	15	0.2
Gravelly lateritic clay	25	0.1
weathered rock	100	0.2

E average = 28.80051 MPa

V average = 0.185101

I=  $I_0 R_k R_v R_b$

L/d	19.8
db/d	1
K	1100.675

From the Tables

$I_0$	0.09
$R_a$	1
$R_k$	1.1
$R_v$	0.88
$R_b$	0.2

I= 0.017424

Layers		layer thickness	d (m)	load on pile (kN)
top	bottom			
0	2.1	2.1	1	2050
2.1	5	2.9		



5	11.3	6.3		
11.3	17.15	5.85		
17.15	19.8	2.65		

**Settlement = 1.24 mm**



University of Moratuwa, Sri Lanka.  
Electronic Theses & Dissertations  
[www.lib.mrt.ac.lk](http://www.lib.mrt.ac.lk)

### 9.4.3. The rationale behind selection of bored piles over other types of piles and foundations

When we get the conditions of this site, its sub soil layer arrangement and the type of building we can get a decision whether we should go for shallow foundation or deep foundation. Since the water table at this area is almost at the ground level, top organic clay layers having poor bearing capacities and this building is a high rise building, obviously we have to go for deep foundation. Bored piles are constructed by drilling a hole into the ground and filling the hole with concrete after inserting the reinforcement cage. In comparison, driven piles are constructed by driving a preformed pile into the ground through application of hammer blows or vibration to the top of the pile.

These are the reasons behind the selection of bored cast in-situ piles over other types of piles

- The length of the pile can be adjusted easily (cost is less)
- Piles need not to transport from the precast yard to the site
- Ground heaving is not a problem. If ground heaving is there it can affect adjacent piles (push upwards)
- Ability to penetrate minor obstructions ( If boulder is present it can settle after some time)
- Can be installed in very large diameters.
- Material of pile is not dependent on handling or driving conditions.
- Absence of vibrations will not disturb adjacent piles or structures
- Potentially better economics than driven piles.

Being non displacement type piles, bored piles can be installed with little or no vibration and with much lower noise levels than driven piles. This will not affect the environment.

### 9.4.4. Construction difficulties and suitable remedial measures

- Presence of medium sand layer- Inserting a steel casing during driving will prevent from collapsing
- Presence of water table at 0.1m depth- So during construction dewatering will need and also remedial measures to prevent any damage should be taken during the construction stage.
- In drilling of borehole loss of small quantity of water from sides of borehole reduces the skin friction and from the bottom of the borehole reduces the end bearing- In this condition concreting should be carried out with “Trimme” pipe, otherwise segregation of concrete may occur.
- Collapse of sides- Good quantity and proper bentonite usage can prevent the collapse of soil.
- Contamination of concrete with bentonite - Remedial action for this is we have to maintain and monitor the required density of bentonite and also contamination.

- If bentonite presence excessively, the friction of the pile and surface surrounding soil will reduce- Remedial action for this is reduce the excessively presence of the bentonite.
- In very hard rock, bored piles can be constructed using down the hole hammer drills or roller cutter core barrels- These techniques allow the drilling of hard rocks economically.
- The concreting process should be continuous and completed without any break.
- Difficulties in cleaning borehole before concreting- Using highly pressurized water jet to clean the borehole before concreting.

#### 9.4.5. Estimation of Skin frictional resistance and end bearing capacities

##### Assumptions

- Completely weathered rock properties also considered as soil.
- For Moderately weathered rock, ultimate skin friction is taken as 200kpa.( From ICTAD)

##### End bearing capacity

It is recommended that piles be terminated within the rock mass having a RQD value more than 50%.

According to the soil report the net allowable end bearing capacity of a pile could vary between 2 N/mm<sup>2</sup> and 7 N/mm<sup>2</sup> depending on the quality and strength of the rock mass. Therefore for the calculations end bearing capacity is taken as 6 N/mm<sup>2</sup>.

##### Skin Friction Coefficient for Basement rock

Recommendation is given in the document for ultimate skin friction coefficient ( $f_u$ ) in basement rock: 200kN/m<sup>2</sup>.

##### Calculation of the capacity of bored pile around BH 11

##### Soil skin friction

##### 1 m diameter piles

Modification factor of the friction angle of the medium sand layer for bored piles

$$\Phi = \Phi - 3^\circ = 28 - 3 = 25^\circ$$

From chart;  $Z_c / d = 5.5$ ;  $d = 1$  m

Therefore  $Z_c = 5.5 \times 1 = 5.5$  m

Effective overburden pressure at the water table depth =  $15 \times 0.1 = 1.5$  kpa

Effective overburden pressure at made ground =  $1.5 + (15.5 - 9.81) \times 2 = 12.88$  kpa

Effective overburden pressure at very soft organic clay =  $12.88 + (17.5 - 9.81) \times 2.9 = 35.181$  kpa

Overburden pressure at critical depth =  $35.181 + (15.5 - 9.81) \times 0.5 = 38.03$  kpa

Below the critical depth level, the effective overburden pressure closer to the pile is constant with depth.

##### Ultimate skin friction

For the bored and cast in-situ piles, the angle of adhesion  $\Phi_a$  is assumed to be equal to the angle of friction of the soil ( $\Phi_a=28$ ).

B factor =  $(1 - \sin 28) \tan 28 = 0.28$

For clay layer  $\alpha$  factor = 1.05 (C = 12.5 kPa)

Ultimate skin friction at water table level =  $\beta \times \bar{\sigma}_v = 0.28 \times 38.03 = 10.65 \text{ kPa}$

For clay layer =  $1.05 \times 12.5 = 13.13 \text{ kPa}$

In moderately weathered rock ultimate skin friction = 200 kPa

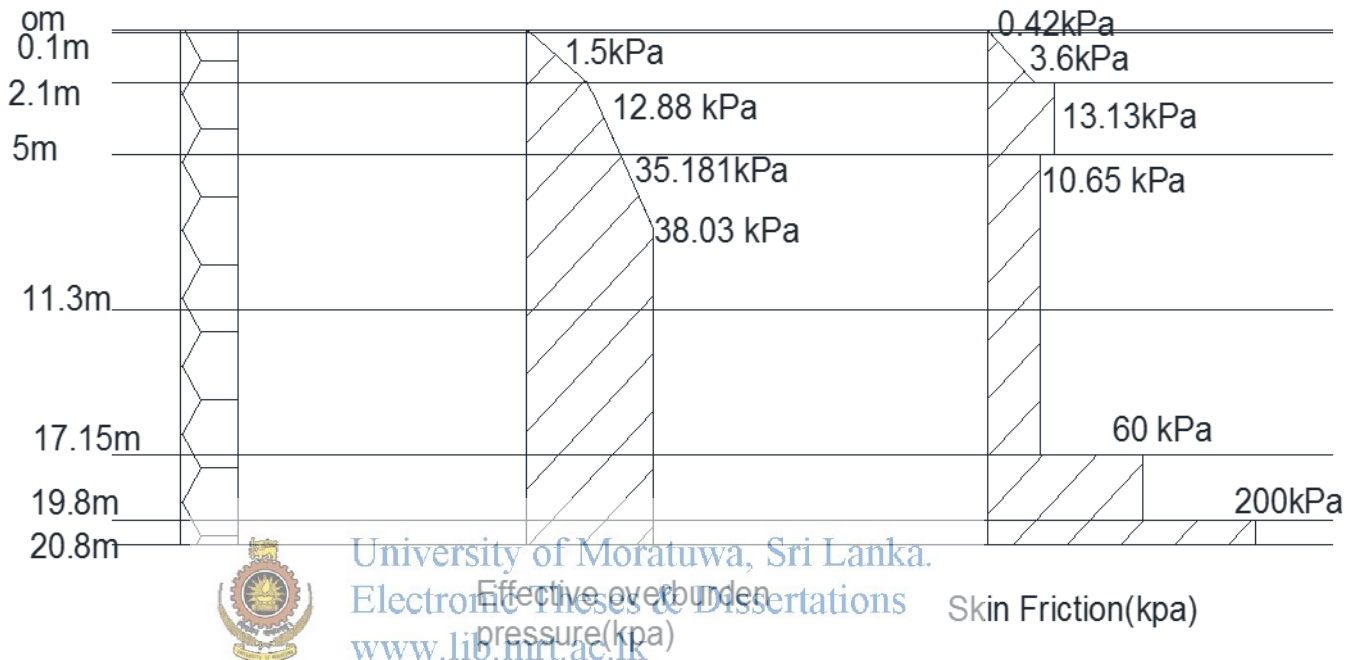

University of Moratuwa, Sri Lanka.  
Electronic Theses & Dissertations  
www.lib.mru.ac.lk  
Figure 9.3 Skin Friction Variation

**Ultimate skin friction**

Calculation for total skin friction

Ultimate skin friction between 0-0.1m =  $0.5 \times 0.42 \times 0.1 = 0.021 \text{ kN/m}$

Ultimate skin friction between 0.1-2.1m =  $0.5 \times 2 \times (0.42 + 3.6) = 0.78 \text{ kN/m}$

Ultimate skin friction 2.1-5m =  $13.13 \times 2.9 = 38.077 \text{ kN/m}$

Ultimate skin friction between 5-17.15m =  $10.65 \times 12.15 = 129.4 \text{ kN/m}$

Ultimate skin friction between 17.15-19.8m =  $60 \times 2.65 = 159 \text{ kN/m}$

Ultimate skin friction between 19.8-20.8m =  $200 \times 1 = 200 \text{ kN/m}$

Therefore total ultimate skin friction =  $530.52 \times \pi \text{ kN}$

= 1667 kN

End Bearing capacity =  $6 \times \pi \times 5002 = 4712.4 \text{ kN}$

Total Capacity of 1m diameter pile = Total Skin Friction + End Bearing

=  $1667 \text{ kN} + 4712.4 \text{ kN} = 6379.4 \text{ kN}$

Shaft Capacity =  $0.25 \times f_{cu} \times A = 5287 \text{ kN}$

Pile Capacity = 5287 kN

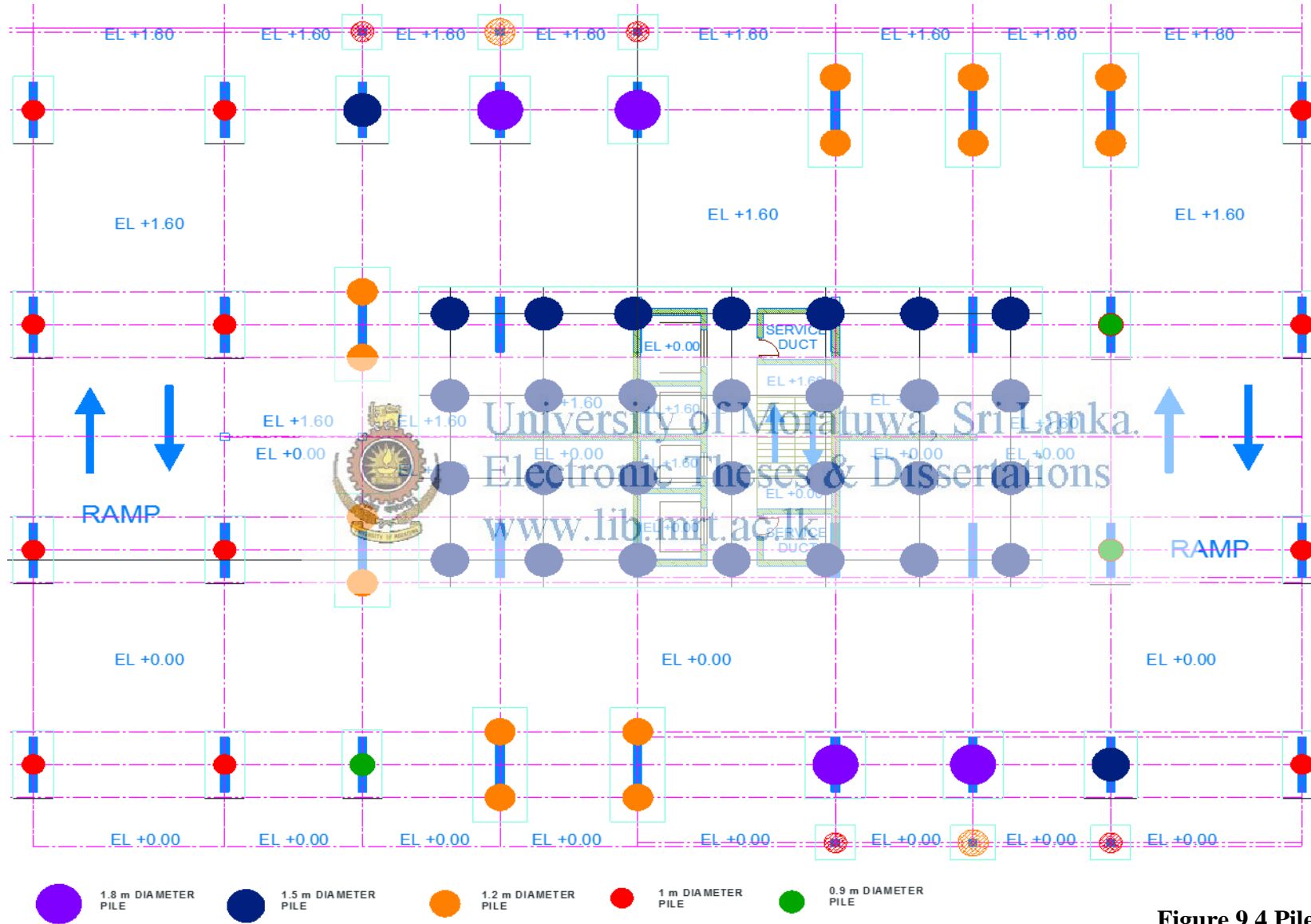
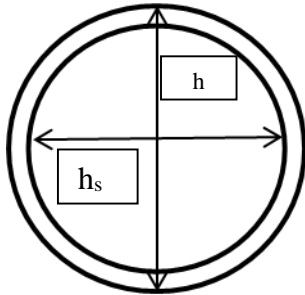

Figure 9.4 Pile Layout

### 9.4.6. Reinforcements for 1 m diameter piles

Capacity of 1 m piles = 5287 kN  
as Follows

Cover For All the Reinforcement



Piles- Sides = 75mm cover

Pile Caps- Top = 75 mm

- Bottom = 100 mm

- Sides = 75mm

1500mm diameter pile

h= 1000 mm

h<sub>s</sub>= 900 mm

Provide minimum of 0.8%

$$\frac{A_{sc}}{A_c} = 0.008$$

$$A_{sc} = 6280 \text{ mm}^2$$

Provide 20T 20

Spacing =  $\frac{\pi \times 900}{20} = 141.37 \text{ mm}$ , so provide at 140mm intervals.

Shear link can be provided at 150 mm spacing with 10 mm diameter bars

Likewise for other diameter piles detaining was done.

Pile Diameter (mm)	Pile capacity (KN)	0.8 % nominal reinforcement area (mm <sup>2</sup> )	Bar Diameter (mm)	Link Diameter (mm)	Link Spacing (mm)
1800	23468	20347	32	12	150
1500	13253	14130	25	12	150
1200	8540	9043	25	10	150
1000	5287	6280	20	10	150
900	4771	5087	20	10	150

Table 9.3 Pile Capacities

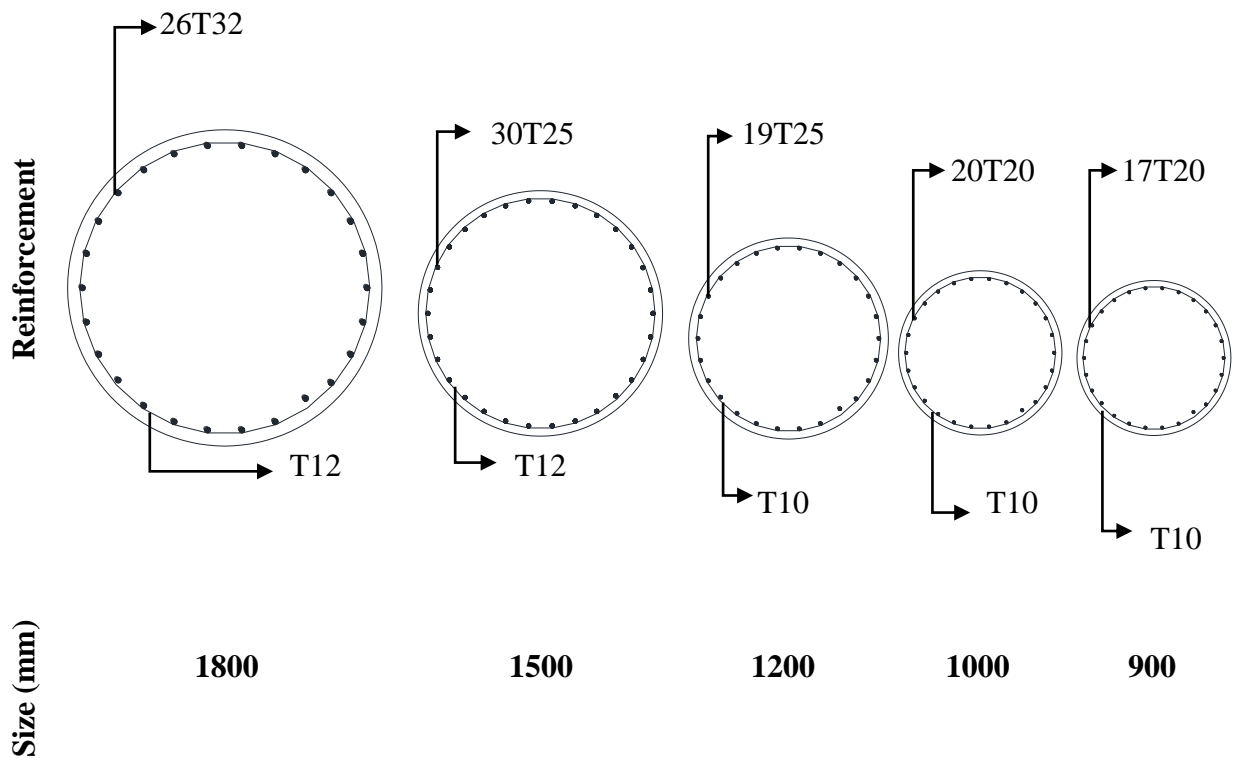

University of Moratuwa, Sri Lanka.  
 Electronic Theses & Dissertations  
 www.lib.mrt.ac.lk  
 Figure 9.5 Pile Reinforcement

9.4.7. Pile Raft Design

Design Geometry

Pile diameter =  $h_p = 1500mm$

Pile spacing factor =  $\alpha = 2.5$

Pile spacing =  $l = \alpha h_p = 2.5 \times 1500 = 3.75m$

**Pile raft dimension**

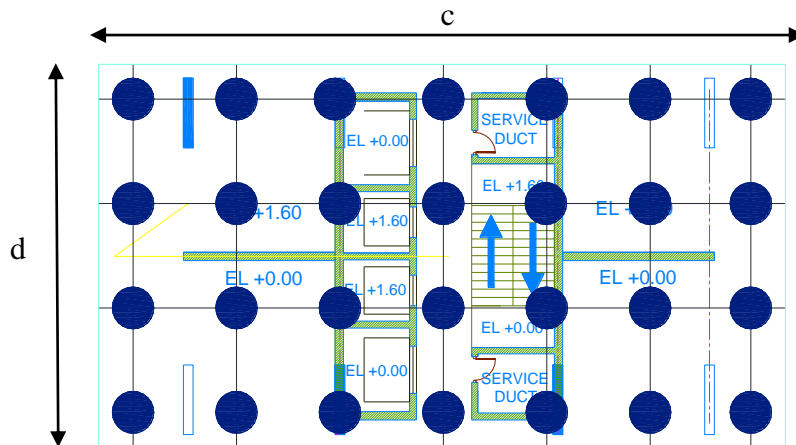

**Figure 9.6 Pile Raft**

$$c = \alpha \times h_p \times 6 + h_p + 1000$$

$$= 1 \times 1500 + 6 \times 1500 \times 2.5 + 1000 = 25m$$



University of Moratuwa, Sri Lanka.  
Electronic Theses & Dissertations  
www.lib.mrt.ac.lk

$$a = \alpha \times h_p \times 3 + h_p + 1000$$

$$= 1 \times 1500 + 3 \times 1500 \times 2.5 + 1000 = 13.75m$$

Depth of the pile cap = 0.5 x c-c spacing + 300

$$= 2200mm$$

Provide 75mm cover for reinforcement, considering extreme exposure condition below ground.

$$\therefore d = 2200 - 75 = 2.125m$$



**Tension r/f**

Maximum Bending Moment sagging (M11)  $\updownarrow$  = 11901 kNm/m

$$f_y = 460 \text{ N/mm}^2 \quad f_{cu} = 30 \text{ N/mm}^2$$

$$K = \frac{M}{f_{cu} b d^2}$$

$$= \frac{11901 \times 10^6}{30 \times 1000 \times 2125^2}$$

$$= 0.086 < 0.156 \text{ singly reinforcement}$$

$$Z = d \left( 0.5 + \sqrt{0.25 - \frac{K}{0.9}} \right)$$

$$= d \times 0.893$$

$$= 1920 \text{ mm}$$

$$A_s = \frac{M}{0.87 f_y Z} = \frac{11901 \times 10^6}{0.87 \times 460 \times 1920} = 1548 \text{ mm}^2/\text{m}$$

The bottom short span steel (B1) is to be provided at T32@125 for three layers

Maximum Bending Moment sagging (M11)  $\leftrightarrow$  = 14647 kNm/m

$$K = \frac{M}{f_{cu} b d^2}$$

$$= \frac{14647 \times 10^6}{30 \times 1000 \times 2125^2}$$

$$= 0.106 < 0.156 \text{ singly reinforcement}$$

$$Z = d \left( 0.5 + \sqrt{0.25 - \frac{K}{0.9}} \right)$$

$$= d \times 0.864$$

$$= 1857 \text{ mm}$$

$$A_s = \frac{M}{0.87 f_y Z} = \frac{14647 \times 10^6}{0.87 \times 460 \times 1857} = 19709 \text{ mm}^2 / \text{m}$$

The bottom short span steel (B2) is to be provided at T32@125 for three layers

### Line shear

Critical position for shear is at  $a_v$  from face of the column

$$\begin{aligned} a_v &= 0.5 \times (l - a) - 0.3 h_p \\ &= 0.5 \times (3.75 - 2.5) - 0.3 \times 1.5 = 0.175 \text{ m} \end{aligned}$$

$$\therefore \text{Shear at the critical section } v = \frac{15170 \times 10^3}{(2850 \times 2 + 2 \times 700) \times 2200} = 0.971 \text{ N/mm}^2$$

$$v_c = 0.79 \left( \frac{100 A_s}{b d} \right)^{1/3} \left( \frac{400}{d} \right)^{1/4} \frac{1}{\gamma_m}$$

$$v_c = 0.79 \left( \frac{100 \times 19709}{1000 \times 2125} \right)^{1/3} \left( \frac{400}{2125} \right)^{1/4} \frac{1}{1.25} = 0.403 \text{ N/mm}^2$$



University of Moratuwa, Sri Lanka.  
Electronic Theses & Dissertations  
www.lib.mrt.ac.lk

$$v_c + 0.4 < v < 0.8 \times \sqrt{f_{cu}}$$

Provide links

$$A_{sv} > b s_v (v - v_c) / 0.87 f_{yv}$$

Provide  $s_v = 200 < d$  (2150 mm)

$$A_v > 354 \text{ mm}^2$$

Provide 10mm diameter shear links T10@200 for both sides

### Punching shear

$$\text{Shear stress at column perimeter } v = \frac{15170 \times 10^3}{(2 \times 2500 + 2 \times 350) \times 2200} = 1.21 \text{ N/mm}^2$$

$$\text{Maximum shear strength} = 0.8 \sqrt{f_{cu}}$$

$$= 0.8\sqrt{30} = 4.38 \text{ N/mm}^2 \geq v$$

∴ Shear resistance for punching along column perimeter is OK

### Anchorage

$$f_y = 460 \text{ N/mm}^2$$

Deformed type 2 bars are used

$$\text{Tension anchorage length} = 34\phi = 34 \times 32 = 1088 \text{ mm}$$

Extend tension r/f 1100mm beyond pile centre

It is then required to bend the bars and extend upwards

Provide 25% main tension steel as horizontal binders

Provide T20@200mm (1571mm<sup>2</sup>)

$$\text{Minimum Bending Moment hogging (M11)} \quad \updownarrow = -3471 \text{ kNm/m}$$

$$\text{Minimum Bending Moment hogging (M22)} \quad \leftarrow \rightarrow = -3987 \text{ kNm/m}$$

$$f_y = 460 \text{ N/mm}^2, f_{cu} = 30 \text{ N/mm}^2$$



University of Moratuwa, Sri Lanka.  
Electronic Theses & Dissertations  
[www.lib.mrt.ac.lk](http://www.lib.mrt.ac.lk)

$$K = \frac{M}{f_{cu} b d^2}$$

$$= \frac{3471 \times 10^6}{30 \times 1000 \times 2125^2}$$

$$= 0.025 < 0.156 \text{ singly reinforcement}$$

$$Z = d \left( 0.5 + \sqrt{0.25 - \frac{K}{0.9}} \right)$$

$$= d \times 0.97 \quad \text{take } 0.95d$$

$$= 2043 \text{ mm}$$

$$A_s = \frac{M}{0.87 f_y Z} = \frac{3471 \times 10^6}{0.87 \times 460 \times 2043} = 4245 \text{ mm}^2 / \text{m}$$

The top short span steel (T1) is to be provided at T32@175

$$K = \frac{M}{f_{cub} d^2}$$

$$= \frac{3987 \times 10^6}{30 \times 1000 \times 2125^2}$$

$$= 0.028 < 0.156 \text{ singly reinforcement}$$

$$Z = d \left( 0.5 + \sqrt{0.25 - \frac{K}{0.9}} \right)$$

$$= d \times 0.97 \quad \text{take } 0.95d$$

$$= 2043 \text{ mm}$$

$$A_s = \frac{M}{0.87 f_y Z} = \frac{3987 \times 10^6}{0.87 \times 460 \times 2043} = 4876 \text{ mm}^2 / \text{m}$$

The top short span steel (T2) is to be provided at T32@150

**For Column C6**  University of Moratuwa, Sri Lanka.  
Axial load N = 15750 kN (Maximum SLS value)  
Electronic Theses & Dissertations  
[www.lib.mrt.ac.lk](http://www.lib.mrt.ac.lk)

#### Determination of number of piles - 1.2 m piles

Capacity of 1.8 m piles = 12 182 kN  
Required No of Piles = 15750 / 8540  
= 1.84  
= 2 pile

### 9.5. Earth Retaining Structure for excavation

The nearby area of this building is a frequently flooding area. Therefore it is needed to rise the ground elevation of the building. The depth of the pile raft is 2.2 m thick. To raise the building by 700mm the excavation should be done up to 1.5 m bellow the existing ground level. Hence the design of the earth retaining system with the shoring system is the one of the main parts of the project. The designing of this earth retaining system is not an easy task. There are lots of factors to be considered. Following shows some important factors considered in the designing earth retaining system.

- Water table of the area
- Depth to the bed rock
- Soil properties with the layer thicknesses.
- Surrounding structures and their foundation types.
- Construction cost and construction technology.

- By considering all those facts, there are lots of earth retaining systems can be used.

Sheet pile wall system, soldier pile wall system, contiguous bored pile wall system and secant pile wall system are some of the methods that can be used as an earth retaining system. Out of these sheet pile wall is selected for earth retaining system.

**Diaphragm wall, Sheet pile is also not suitable because of the following reasons.**

- Not having a basement: Here water table is pretty much above the required excavation depth hence dewatering is carried out. In order to create water free surface until the foundation construction is over, temporary water tightness of the support system is essential. Though Diaphragm walls and Sheet pile walls can provide a water tight retaining structure, for maximum 1.5m excavation the cost for them is high. But by using soldier pile wall which is constructed with I sections, concrete panels and a continuous pumping mechanism, it is possible to have a water free excavation area.
- Temporary solution: In this area bed rock is in 14.2- 23 m depth range. So if we go for a permanent structure it would be a great cost for a temporary water tightness.
- Construction duration problems: Construction of bored piles, diaphragm walls or sheet piles take long period of time. Hence construction of shoring system is less duration needed.
- Less water tightness of the soldier pile walls: From the spaces between timber planks or concrete blocks water will be leaked out and that water can be pumped out from the construction site.
- Cost of the construction: When we compare the cost for bored piles and the cost for sheet piles, there is a huge reduction of cost by choosing shoring system.

So the options remaining to be chosen, which meets the required structural capacity, water tightness and constructability is a shoring system. Soldier pile wall is the best option to support this excavation. Short term analysis is performed here.

## 9.6. Procedure

Plaxis analysis is analysed as 2D model. The area dimensions covered from the soldier pile wall construction is about  $40 \times 55 \text{ m}^2$ . The critical direction is chosen to generate the 2D model. The critical direction is 55 m wide section. Symmetricity of the structure exists. That thing also considered for the model preparation. 55m length area is taken to build up the model covering with the standard fixities around the model. The distributed load is applied near to the building to ensure the extra load is applying near to the building. In BS8002 stated that minimum load of  $10 \text{ kN/m}^2$  should be applied. Therefore  $10 \text{ kN/m}^2$  is applied to the model. In the actual situation this kind of  $10 \text{ kN/m}^2$

is not applied. Because all the near structures are going to be built on soldier pile system. If the horizontal displacement of the piles is very low, then not much of horizontal load is applied on the soldier pile system due to other near structures.

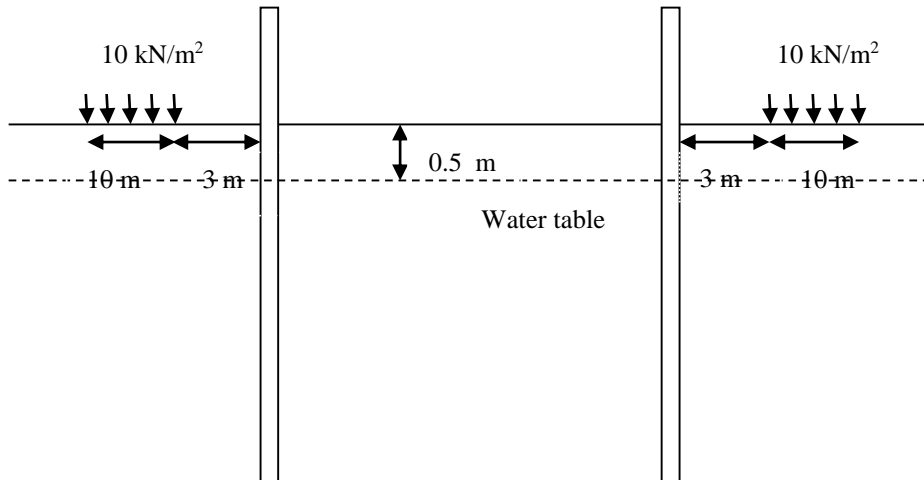

Figure 9.7 Section view of the excavation

### 9.6.1. General Details

Model – Plain Strain

Elements – 15 nodes

Since the geometry is symmetric, only one half is considered in the analysis.

It is necessary to ensure that the maximum deformation anywhere in the retaining side should be less than 50mm at any stage during and after the construction.

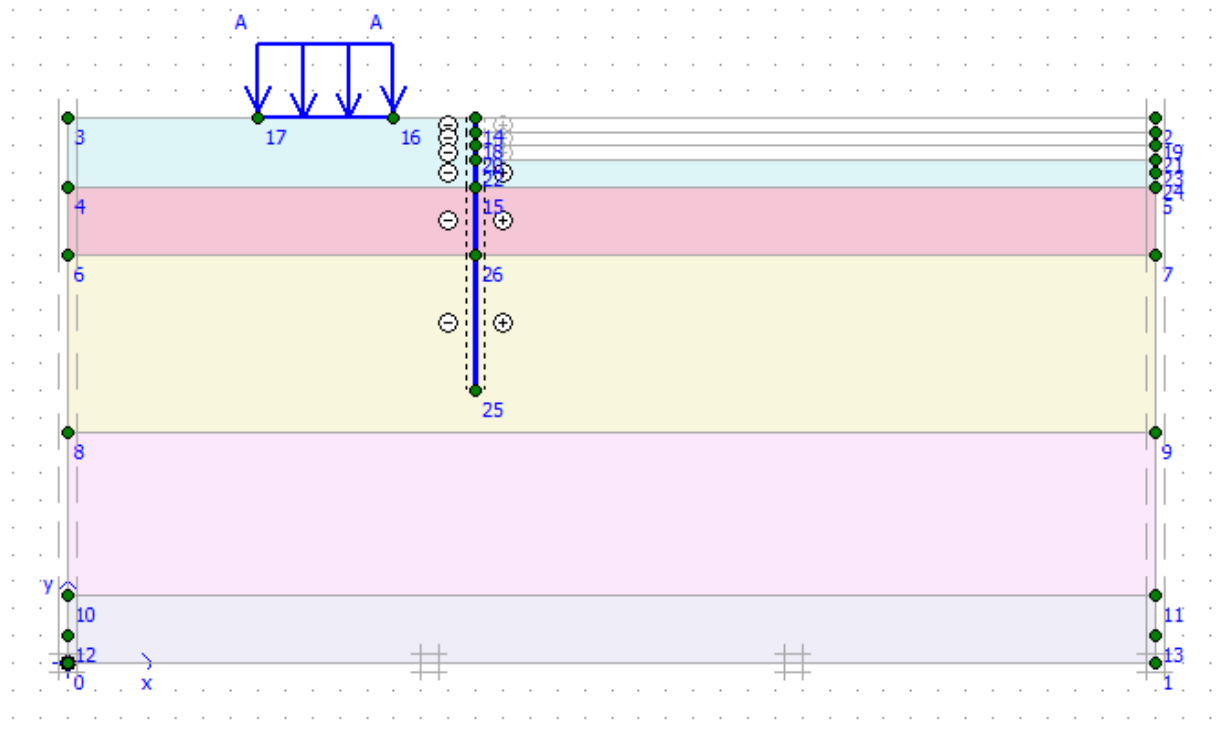

Figure 9.8 Geometry model of the window

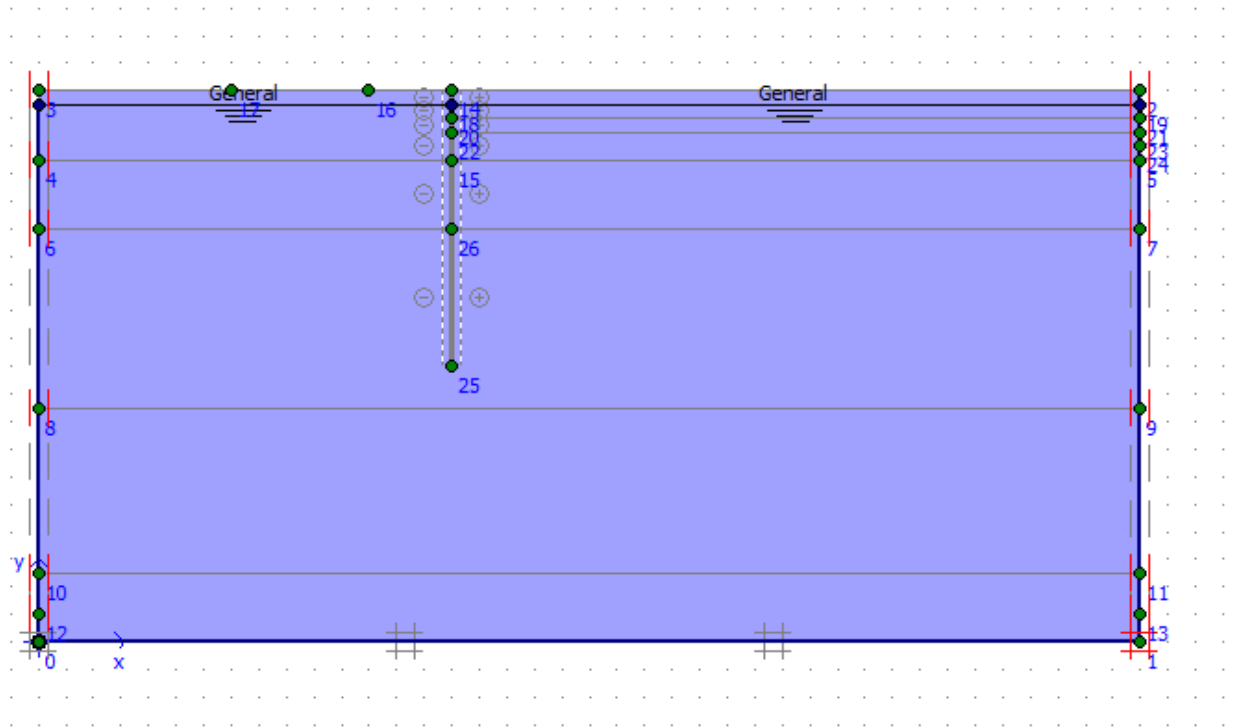

Figure 9.9 Initial Water table level

Stage 1

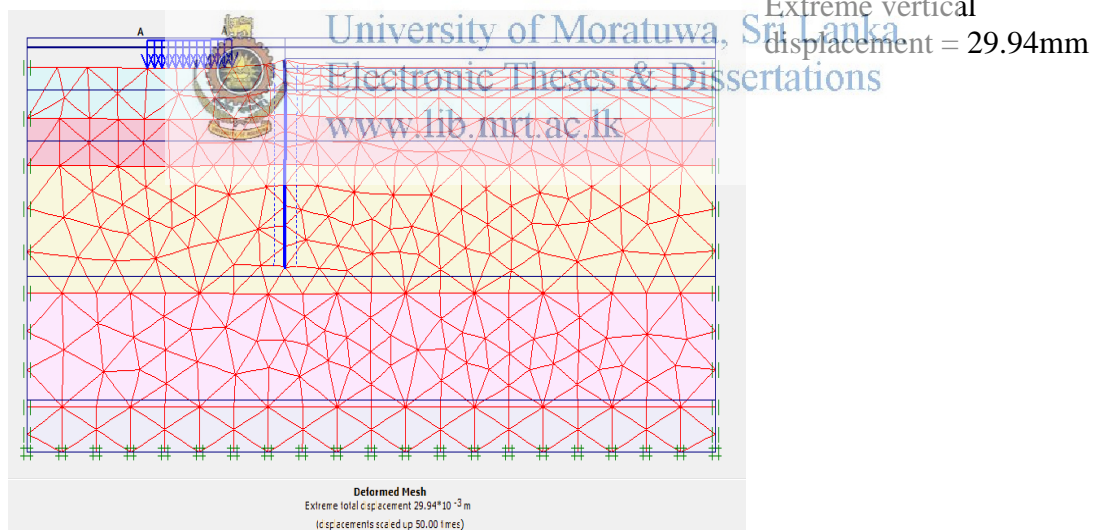
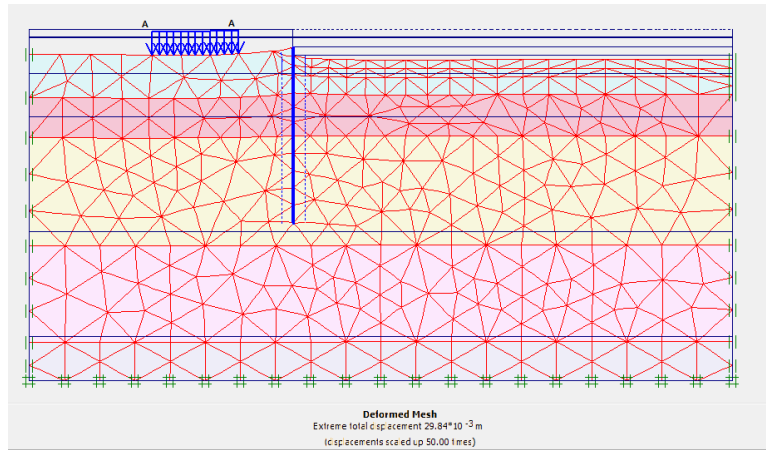

Figure 9.10 Installing Retaining wall and applying load due to existing buildings

Stage 2



Extreme vertical displacement = 29.84 mm

**Figure 9.11 Excavating up to 0.5 m from the ground level**

Accordingly excavate up to 1.5m by 0.5 m excavation depth in one stage  
**Stage 4**

**Excavating up to 1.5m from ground level and dewatering**  
 Extreme Total Displacement = 32.45 mm

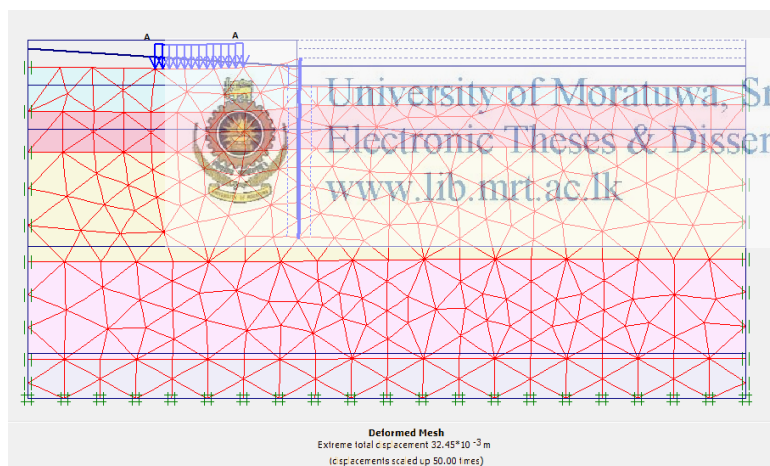

Hence Extreme Total Displacement of the retained wall is within prescribed limits (50 mm). So no need to go for the lateral support system.

**Figure 9.12 Total Excavation**



### Maximum vertical displacement

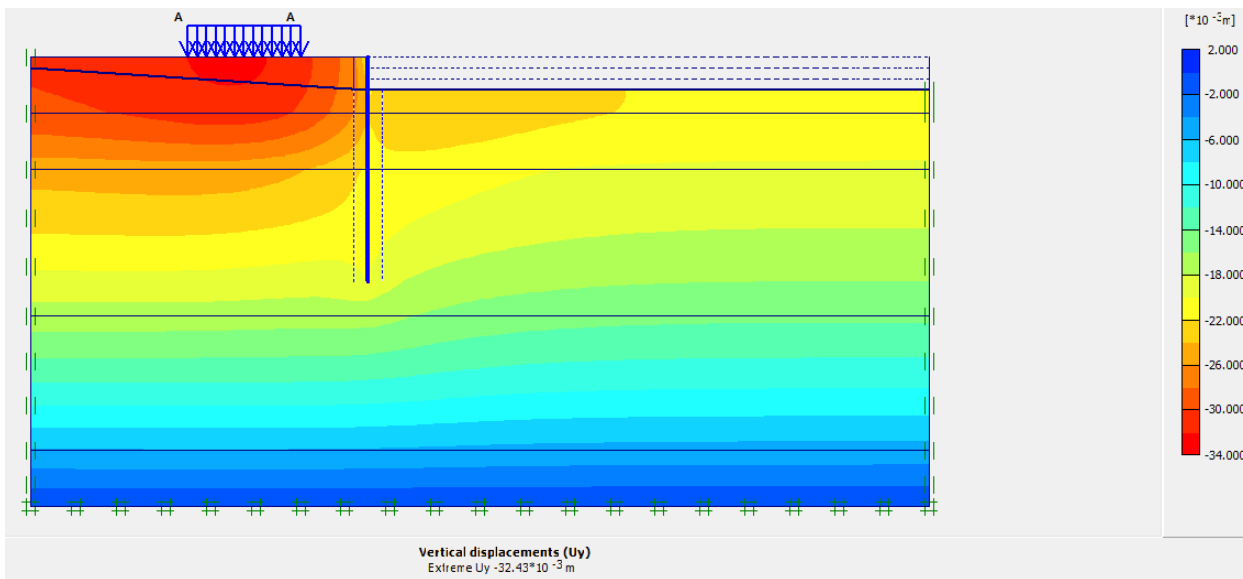

**Figure 9.13 Vertical Displacement**

#### Vertical displacement after 1.5m excavation

Maximum vertical displacement after 1.5 m excavation is 32.43 mm.

From the plaxis results, the deformations were kept within limits prescribed (50mm). The water table depth is 0.5 m below the ground surface. But in heavy rainy seasons water table level will increase. It will increase the active pore water pressure. So during heavy rainy season there is a possibility to exceed the deformation above 50 mm. As a precautionary measure and for the use in other instances, the following measures can be used to reduce the deformations.

- Anchoring of retaining wall

Using different anchoring mechanisms the retaining wall can be anchored. But here, three storied buildings supported on shallow foundations exist on three sides of the site of the proposed building. So if we want to anchor the retaining wall we have to get the permission from the adjacent land owners.

- Use of props at different levels of the excavation.

We can maintain the deformation within the limits by using props also. But they will act as a temporary support system. So after the excavation is done, the props can be substituted with more permanent structures like slabs.

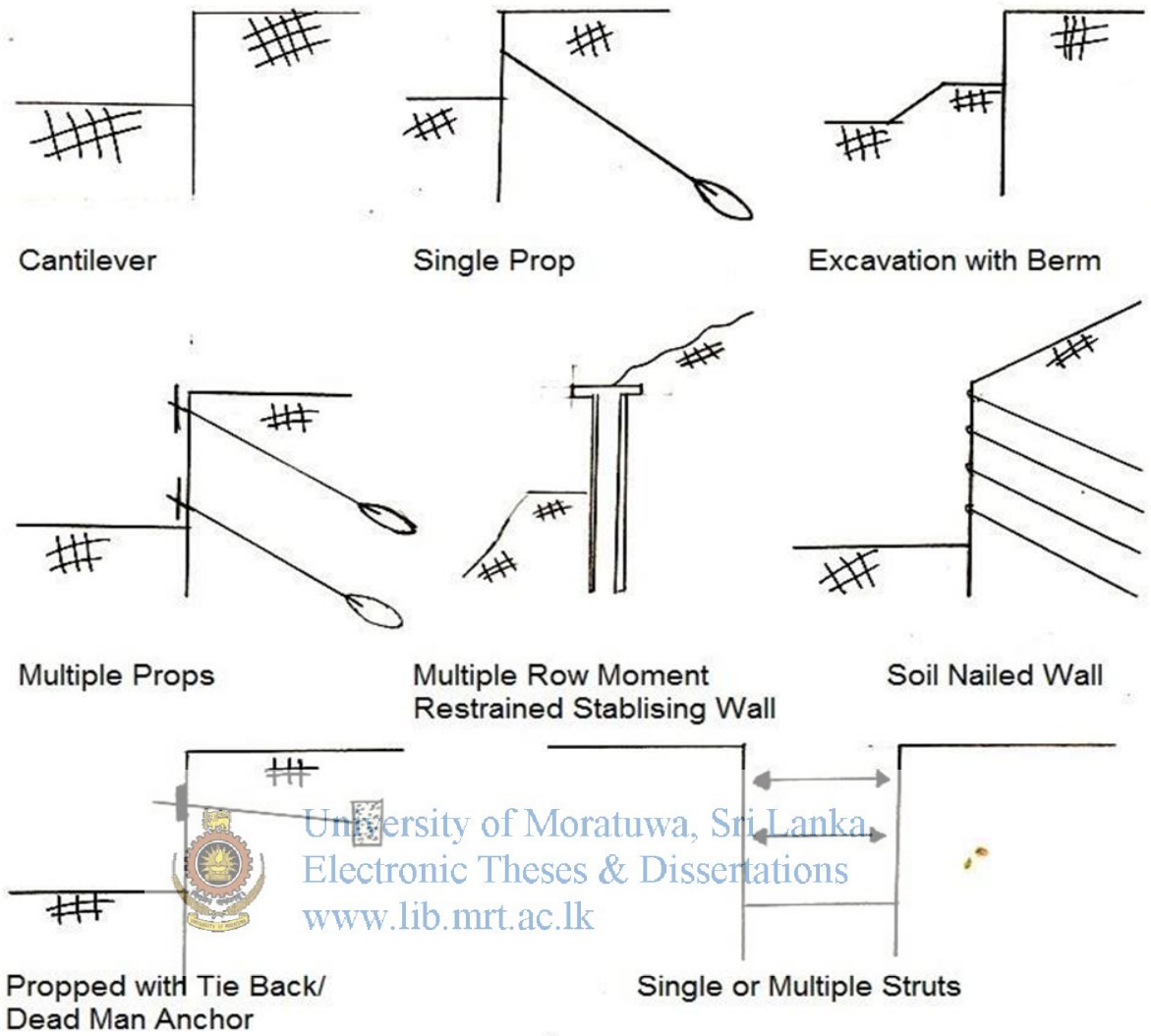

**Figure 9.14 Methods to reduce the deformations in soil retaining structures**

## 10. SUSTAINABLE CONCEPTS ADOPTED

### 10.1. LEED Certification for the building

The Leadership in Energy and Environmental Design certification is informally referred to as LEED. It is a program sponsored by the U.S. Green Building Council and LEED certification is designed around the concept of sustainability. There are seven prerequisites and credits are considered in offering the LEED certification for buildings and a point system is used to evaluate them.

1. Location and Linkages (10 points)
2. Sustainable Sites (22 points)
3. Water efficiency (15 points)
4. Energy and Atmosphere (38 points)
5. Materials and Resources (16 points)
6. Indoor air quality (21 points)
7. Innovation and Design (11 points)
8. Awareness and Education (3 points)



University of Moratuwa, Sri Lanka.  
Electronic Theses & Dissertations  
[www.lib.mrt.ac.lk](http://www.lib.mrt.ac.lk)

After the evaluation results 4 certificates are offered based on the total points obtained

- Certified 40-49 points
- Silver 50-59 points
- Gold 60-69 points
- Platinum 70 and above

Attempts on obtaining this certificate for a residential building like this is not an easy task and no such project in Sri Lanka has ever attempted it. So, we have accepted a challenge in proposing the greenest residential building project in Sri Lanka and to try and obtain the silver certificate for the sustainability of our building. (ANNEX4- POINTS OBTAINED)

### 10.2. Location, Linkages and Sustainable Site Planning

Site location, its connectivity with the surrounding and proper site planning are equally important aspects of sustainability in a building project. Site planning assesses a particular landscape to determine its appropriate use, then maps the areas which are most suitable for accommodating specific activities associated with that use. The purpose of this categorization of analysis is to integrate design and construction strategies by modifying both site and building

to achieve greater human comfort and operational efficiencies. Here we highlight the green site-planning strategies and practices which are specifically related to this project.

### 10.2.1. Site Selection (Max. points: 2)

Site selection is the first step of a sustainable construction and needs to be done appropriately, prior to the commencement of design phase. However in our project we didn't have the luxury of considering several site locations for the project. So the given location at Buthgamuwa Road had to be accepted for the design.

The nearest bus stop is within 100m from the site. With the proposed mono-rail system from Malabe to Colombo which goes through the town of Rajagiriya, we can expect a comfortable and speedy transportation for the people who live in this area in near future. Banks, Post-offices, gas-stations and all other basic facilities are within close proximity to the site. So there is no argument about the selection of this site for an apartment building.

### 10.2.2. Surface Water Management (Max. Points: 6)

Site is located at a flood controlling area. So the storm water generated from the site should be properly discharged to the environment.

- At the construction stage we can take little use from the storm water since it may contain excessive soil particles or other waste related to construction sites, regardless of the effort we take to minimize them. So the water collected from drains will be discharged safely through a specially constructed filter zone (which will be located at the South-West part of the land.) It will be constructed with a sand, gravel and boulders from bottom to top. And at the end where water is discharged to the stream, we'll provide a geotextile layer future to improve the water quality.
- Pervious pavement will be used to increase infiltration. So the roads are constructed with Cement Stabilized Earth which can reduce the heat island effect also.
- At the operation stage of the project effective rainwater harvesting system will be used.

### 10.2.3. Soil Conservation (Max. Points: 2)

The soil of the site is not suitable for any kind of back filling. So, there is no use of preserving the excavated soil at site. But we may have to temporarily store them before removing them to a selected dumping area. And the soil which is used for backfilling may have to be temporarily stored on the site.

- There for we should make sure those stock piles at site are protected with impermeable materials (e.g. Polythene) and provide barriers at the toe of the stockpile to stop surface runoff, reaching the toe of the stock pile.



**Figure 10-1: Well protected stock pile** University of Moratuwa, Sri Lanka.

- And it is proposed to have retaining walls with geotextile barriers along the site premises.



**Figure 10-2: Geotextiles and their applications**

- All drains will be lined with concrete or precast cylinders will be used for construct them.
- Moderate and treat runoff from roofs and unavoidable impervious pavements, and, to the degree possible, return it to its natural path in the soil.



**Figure 10-3: Protected Drains**

- Landscape plan will minimize the future erosions at operation stage.
- To avoid dust generation water will be sprinkled on the soil vehicles which are leaving from the site will be washed prior to leave.

#### **10.2.4. Development of density and Community Connectivity (Max. Points: 3)**

As mentioned above the surrounding area of the site consists of dwellings of local community. And most of them can be considered as middle class people from the types of houses they have built. So it is a challenging task to build a positive image about the project since they love to have the quiet and peaceful environment of the area, which existed before the project was proposed. So, it is a necessity to avoid generation of wrong image about the project, the people of that area should be educated about the project.

Especially the increasing land value of the area due to the project and possible improvements of the infrastructure of the area will be beneficial to them. And for the people who are interested in joining the construction crew who live in the area, will be given the priority. And the people at immediate neighbourhood of the site will be considered to have the access to the gym and the restaurant on 5<sup>th</sup> floor of the building.

#### **10.2.5. Alternative transport (Max. Points: 6+1)**

It is obvious that worker's billets can't be constructed inside the site with the small amount of available land. So they should either come from their homes or externally located billets. The site is at a walking distance to the bus stop. But we can't expect construction workers to use it for their day to day transport. So most practiced option is having a bus or a vehicle dedicated to transport vehicles.

- Instead, we encourage usage of bicycles and we provide "Bicycle Storage and changing room" at site. There will be several bicycle storage cabins with changing room facility for the employees hired from nearby areas.
- The vehicles which facilitate the transportation of high level staff (Project Manager, Chief Engineer, etc.) would be hybrid vehicles which are more Eco-Friendly.
- The most Eco-friendly way of travelling is the use of electric vehicles. We try to make electrical charging stations be available from the middle stage of construction of the building, where the construction staff also get benefited from it.



**Figure 10-4: An Electric Car Re-charging Station**

#### **10.2.6. Landscaping and Protecting of Habitat (Max. Points: 1)**

When laying out the building in the plan, special attention was given to minimize the disturbance to the eco system. So the building was located away from the nearby stream which enables us to have a better garden as well as minimum disturbance to the eco-system by the stream, specially the trees.



University of Moratuwa, Sri Lanka.  
Electronic Theses & Dissertations  
[www.lib.mrt.ac.lk](http://www.lib.mrt.ac.lk)

- Native plants or well-adapted species are selected.

Category	Name	Location
Small Plants	Chilies, Petunia, Pilea, Artillery	Balconies
Medium Plants	Shrub Rose, Tomatoes	Balconies, Rooftop Garden
Large Plants	Miniature Rose, Ixora Casei	Balconies, Rooftop Garden, Site Gardening
Large Trees	Indian Mulberry, Mango, Plumeria	Site Gardening

**Table 10-1: Selected Plants for the Building**

Plants with low or nor irrigation requirement will be given preference. Native plant populations in the existing site are preserved. Restore the native landscape as much as possible at the time of project completion.

- Chemical fertilizers, pesticides etc would not be permitted to use.
- Efficient outdoor lighting systems are used in both construction and operation stages.
- Properly located & built internal roads and foot paths enable the circulation of the land more effective and efficient.

### 10.2.7. Sanitary and Safety Facilities

- We ensure the health and safety of workers during construction, with effective provisions for the basic facilities.
- Provide clean & healthy drinking water to all workers.
- Provide adequate number of decentralized latrines and urinals to construction workers.
- Provide necessary safety equipment/machinery with sufficient quantity.
- Safety officer should be allocated for the site.
- First-aid box and stand-by vehicle at every time at the site to be used at an emergency will be provided



### 10.2.8. Pollution Mitigation

- All mitigation measures described in IEE report would be effectively executed during the construction stage to stop air, noise, vibration and waste management in the site
- Proper traffic management plan will be practiced to reduce the unnecessary traffic at construction activity (Especially at concreting work where we have to bring ready mixed concrete outside of the land)



### 10.2.9. Water Efficiency

Water is a priority in sustainable design, since it would be a main element in the budget and also it is a scarce resource. There are mainly three aspects we have considered when addressing the water efficiency of the project.

- Water Reuse
- Irrigation Systems
- Indoor Water Use



### 10.2.10. Water Reuse (Max. points: 5)

### 10.2.11. Rainwater Harvesting System

Rainwater harvesting (RWH) presents many benefits for urban sustainability and it is emerging as a key strategy in order to cope with water scarcity in many cities.

Using the rainfall duration frequency relationship,

$$I = X \times D^{-Y}$$

I= Intensity of rain in inches/hr

Hydrological zone boundary 3 (Colombo district), Sri Lanka.

Considered return period = 50 years

From the design manual of "Irrigation Headworks for Small Catchments";

Rainfall constant X=167.77, Y= 0.844

Considered duration of rainfall intensity D = 30 minutes

$$I = 167.77 \times 30^{-0.844} = 9.5 \text{ inches/hr} = 241 \text{ mm/hr}$$

Using the rain flow discharge relationship  $Q = CIA/360$

C= Runoff coefficient

Location	Runoff Co-efficient	Area (m <sup>2</sup> )
Total Roof area of buildings	0.8	2000
Internal Roads (Cement Stabilized)	0.4	470
Garden (Landscaped Area)	0.3	2064
Pond	0	112.5

**Table 10-2: : Runoff coefficients, Source: Sri Lanka Green Building Council**

$$\begin{aligned}\text{Combined runoff coefficient} &= \frac{\sum AiC}{\sum Ai} \\ &= \frac{0.8*2000+0.4*470+0.3*2064+0*112.5}{4647} \\ &= 0.54\end{aligned}$$

$$\begin{aligned}\text{Therefore, } Q &= (0.54 \times 9.5 \times 1.14) / 360 \\ &= 0.0164 \text{ cfs} \\ &= 0.58 \text{ m}^3/\text{s}\end{aligned}$$

But getting this kind of heavy rain is very rare. According to the monthly rainfall of the Colombo district, in 10 months of the year rainfall of the area comes near 125mm per month and no of days the each month has rainfall exceeds 15 days in 8 months. So, it is safe to assume 100mm of rain is the maximum precipitation which can be consistently harness around the year from the area. (ANNEX4: Rainfall Data- Colombo)

And let's assume only 54% of this rain can be collected, since the runoff coefficient is 0.54

Therefor the maximum quantity of water which can be collected from the site

$$= (0.100 * 4547 * 0.54)$$

$$\begin{aligned}\text{After evaporation and other losses (per month), } &= 245 \text{ m}^3 \\ &= 245 \times 0.5 \\ &= \underline{122.5 \text{ m}^3}\end{aligned}$$



University of Moratuwa, Sri Lanka  
Electronic Theses & Dissertations  
www.lib.mrt.ac.lk

Let's assume 110 m<sup>2</sup> of land under the Summer Hut is separated for a Rainwater Harvesting Tank.

Take the height of the tank is 1.2m

- The maximum water quantity the tank can be collected= 132 m<sup>3</sup>
- A well maintained drainage system will be used to direct rain water to the tank.
- A bar rack/a fine screen will be used to remove the floating solids in the rain water, which enter to the tank
- Water collected from rain water harvesting will be used for vehicle washing and gardening

### 10.2.12. Waste water treatment plant

#### Introduction

It is not an essential requirement to have a waste water treatment plant since there is existing sewage or waste water collection pipeline system going through nearby. So one method is to, directly connect the water pipe of the building to the sewer pipe line. But one main objective of the Sky Residencies (pvt) Ltd is to obtain the Green Certificate for the building hence because

of that waste water treatment plant is planned. Effluent water may be discharged to the Kotahena Lake.

### Flow Estimation

#### Flow estimation is done according to the SLS 745 part II

Category – Luxury- Housing apartment complex

All waste water treatment

Per capita waste water flow – 240 l / person / day

#### Total population calculation

Total number of apartments – 160

No of two bed room Apartment – 80

No of three bed room Apartment – 80

Assume 1.5 person per room,

For 3 bed room apartment,

Total population =  $1.5 * 3 + 1$  (maid)

$$= 4.5 + 1$$



University of Moratuwa, Sri Lanka.  
Electronic Theses & Dissertations  
[www.lib.mrt.ac.lk](http://www.lib.mrt.ac.lk)

For 2 bed room apartment,

Total population =  $1.5 * 2 + 1$

$$= 3 + 1$$

$$= 4$$

Hence, total population =  $6 * 80 + 4 * 80$

$$= 800$$

Total waste water generation =  $800 * 240$

$$= 192000 \text{ l / day}$$

$$= 192 \text{ m}^3 / \text{day}$$

Parameter	Unit Type Of Limit	Tolerance Limit Values
Total suspended solids,	mg/l	Max. 50
pH at ambient temperature	-	5.5 - 10.0
Temperature	0C	Max. 45
Biochemical oxygen demand	mg/l	Max. 30

(BOD5 in five days at 200 C or BOD3 in three days at 270C)		
Chemical Oxygen Demand (COD)	mg/l	Max. 250

**Table 10-3: Tolerance limits for discharge of effluents into public sewers with central treatment plants -National Environmental Act, No. 47 OF 1980 - list vii**

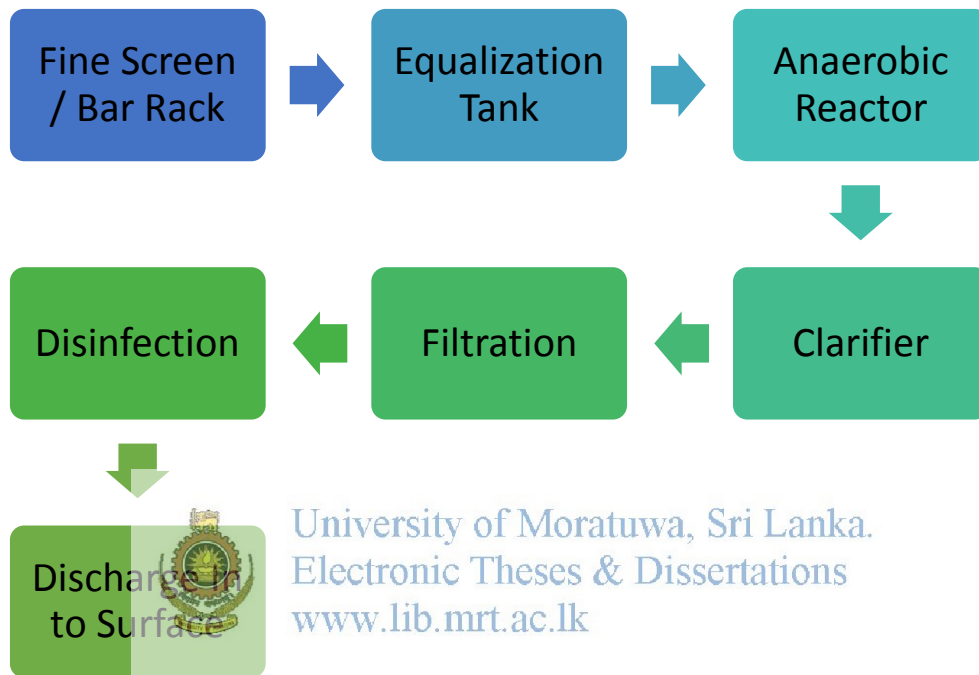

**Figure 10-5: Proposed Unit Processes**

**Fine Screen / Bar rack**

A screen is a device with openings, generally with uniform size that is used to retain solids found in the influent. Main aim is to remove the larger debris come with the waste water which may damage the equipment in the sequent processes. Recommended to use fine screen. Static wedge wire fine screens are proposed and it has to be manually cleaned once it blocked.



Static wedge wire fine screens- Size – 0.25 – 2.5 mm

Screen Medium – Stainless- steel wedge wire screen

## Equalization Tank

Wastewater does not flow into a municipal wastewater treatment plant at a constant rate. Even in dry weather, the flow rate varies from hour to hour also most the apartment buildings have high waste generation with in morning time and its drops in late morning and again rises in the noon then drops. So it is essential to maintain a constant flow through out all the time.

(ANNEX4: Hourly flow rate calculation)

The average flow rate that leaves the equalization basin =  $0.00266 \text{ m}^3/\text{s}$

The average volume that leaves the equalization basin =  $0.00266 * 3600 = 8 \text{ m}^3$

(ANNEX4: Volume calculation of the Equalization Tank)

Required storage =  $23 \text{ m}^3$

By adding 25% safety factor =  $23 * 1.25 = 28.75 \text{ m}^3$

Depth of equalization tank = 2m

Width = 3m

Length = 5m

## Anaerobic Digestion

Septic tanks with bio filters cannot be proposed for this project since due to limited land area. Aerobic digestion is also not suitable because it needs larger area of land. So the most suitable method is to go for anaerobic reactor.

Following features can be identified in an aerobic digestion,

- Microbial reactions take place in the absence of molecular/ free oxygen
- Reactions products are carbon dioxide, methane and excess biomass

- Net Sludge Yield Relatively low (generally one fifth to one tenth of aerobic treatment processes)
- Foot-Print need is relatively small and compact
- Capital Investment is relatively low

**Up flow anaerobic sludge blanket (UASB) reactor**

There are several types of anaerobic reactors for the proposed treatment plant up flow anaerobic sludge blanket reactor can be identified as the most suitable technique

**Design Calculations**

Determine the reactor volume

$$V_n = QS_o / L_{org}$$

V<sub>n</sub> – effective liquid volume of reactor

Q – Influent flow rate

S<sub>o</sub>- Influent COD

L<sub>org</sub> – Organic Loading Rate (change with the temperature)

$$V_n = (192 \text{ m}^3/\text{d}) * (1 \text{ kg sCOD/m}^3) / (6 \text{ Kg sCOD/m}^3 \cdot \text{d})$$

$$V_n = 32 \text{ m}^3$$

Determine the total reactor volume = 32 / 0.85

$$= 38 \text{ m}^3$$

Area of the reactor

$$A = Q / V$$

A =Reactor cross section area

Q = influent flow rate

V = Design upflow superficial velocity

$$A = 192 \text{ m}^3 \cdot \text{d} / 0.9 \text{ (m/h)} * 24 \text{ (h/d)}$$

$$= 8.89 \text{ m}^2$$

$$A = \pi D^2 / 4 = 8.89 \text{ m}^2$$

Required Diameter = 3.36 m

Determine the height of the reactor = 38 / 8.89 = 4.27 m

Proposed Diameter = 3.4 m

Proposed height for reactor = 4.27 m

Hydraulic retention time = V<sub>L</sub> / Q = 38 (m<sup>3</sup>) \* 24 (h/d) / 192 (m<sup>3</sup>/d) = 4.75 hours

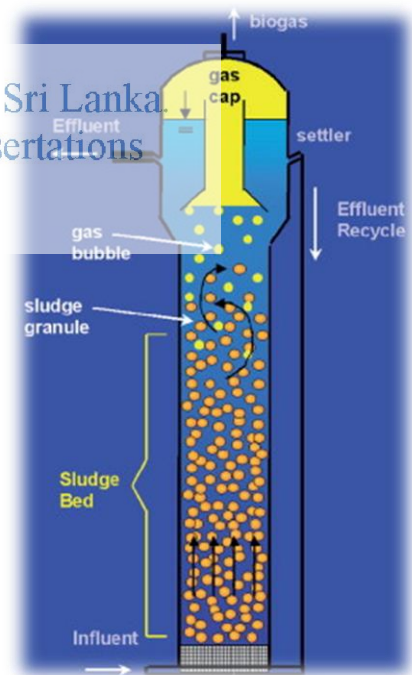

**Figure 10-6: Up flow Anaerobic Sludge Blanket (UASB) Reactor**

## Filtration

Pressure filters are proposed since it require low area of land.

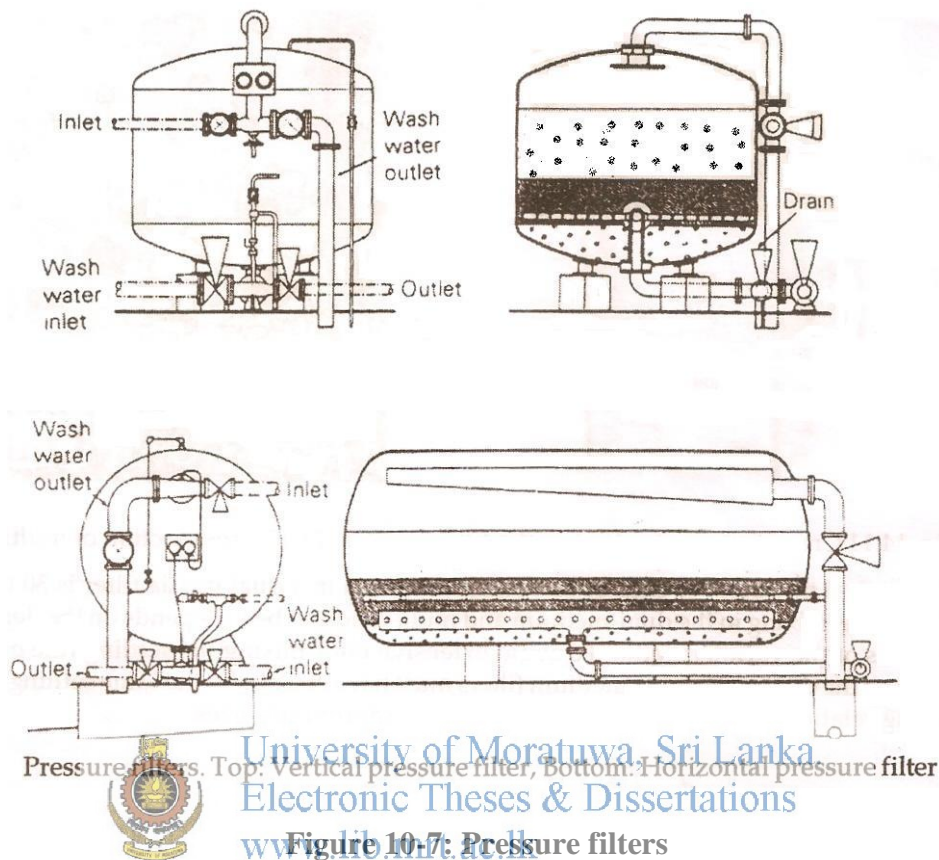

Figure 10-7: Pressure filters

## Disinfection

To destroy 99.9% micro-organisms,

From Chicks Law we can establish that,

$$\text{Time of Contact (t)} = \frac{2.303}{k} \log_{10} \frac{N_0^0}{N_0}$$

For Chlorine rate constant (k) =  $1.6 \times 10^{-2}/s$

$$t = \frac{2.303}{1.6 \times 10^{-2}} \log_{10} \frac{1000}{1}$$

$$t = 431.8s = 7.3min$$

Time of contact = 7.5min

### 10.2.13. Irrigation System (Max. Points: 4)

There are four types of gardens, in our designed building.

1. Small gardens on each balcony of the building to improve the thermal comfort of the building
2. Vertical garden to provide extra shading and pure air for the car- park
3. Allocated land for landscaping of the building

#### 4. Roof top recreational area

Different trees/plants will be grown on these places with different requirements of water for them.

##### 1. **Small gardens on each balcony**

Since private balconies of apartments are not so big, and small trees are grown in them, we assume they are watered manually by the occupants themselves. Those balconies will be provided “small individual drip irrigation systems”, according to the requirement of different occupants. Cost of such a small system with Overhead tank of 10l capacity, pipe network and flow control valves will cost less than Rs. 10000 per 20m<sup>2</sup> balcony. And gravity will be used to maintain pressure in these small systems.



**Figure 10-8: Gardens on Balconies**

##### 2. **Drip irrigated vertical garden**

A green wall can be defined as a vertical garden that is grown on the wall of a building or that is freestanding. In fact, they are commonly called vertical gardens.

For a vertical garden to succeed and thrive, it needs to be well watered, especially if it is attached to a wall that is exposed to plenty of sun and wind, like in our case. We select a Gravity Fed Drip Irrigation System, since the simplicity and the low cost of it.

Here conventional drip irrigation system is installed at the top of the vertical garden. Water is released and it drips onto the top row of plants. As these plants are sufficiently watered, the water continues down through the effect of gravity, until the entire garden is watered. The excess water is collected at the bottom of the garden and is drained away. Alternatively, a pump can be installed to recycle the water.



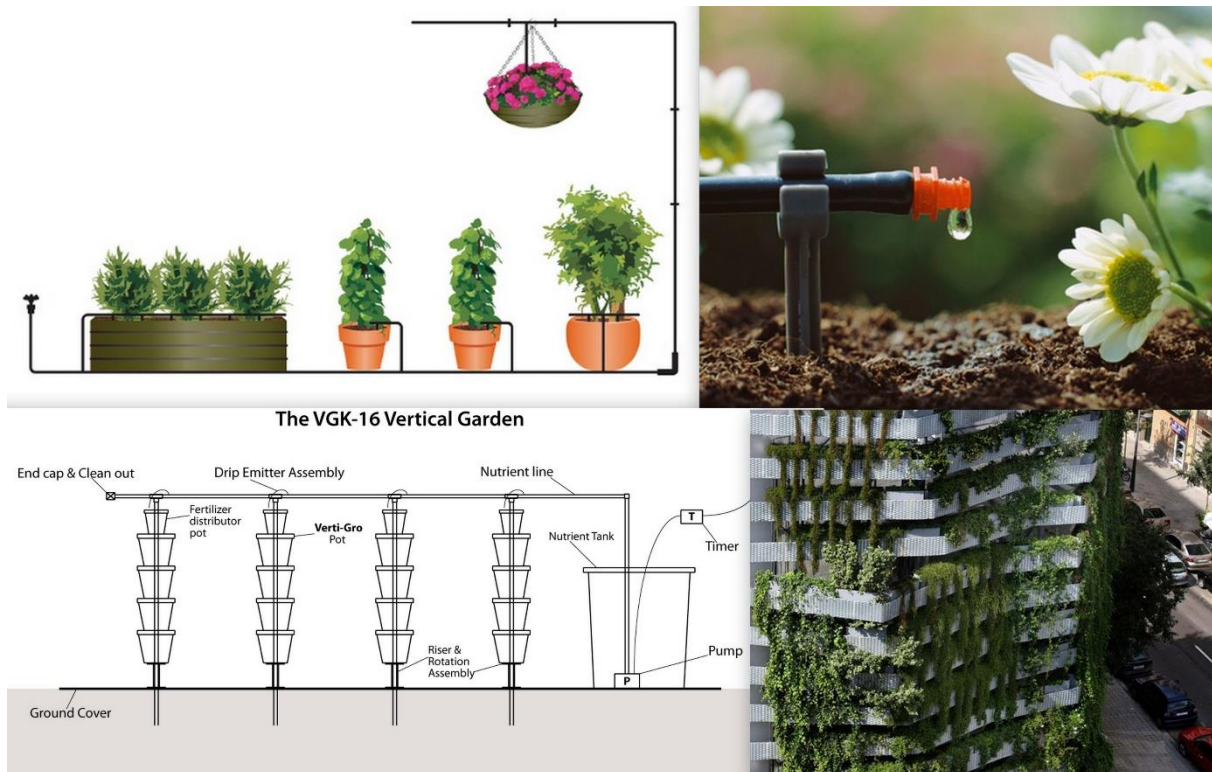

**Figure 10-9: Drip Irrigation Systems for the balconies (top) and for green wall (bottom)**

Using some approximated calculations, it could be found that the water requirement for the whole irrigation/gardening work of the building per day is less than  $10\text{m}^3$ , if we use the drip irrigation system.

#### 10.2.14. Indoor Water Use (Max. Points: 6)

##### Reduce Building water usage

The potable water usage can be reduced by using water conserving fixtures in both construction and operation stages of the project. It reduces the water bills and save water, which is an important natural resource. In addition, efficient water use reduces energy needed to pumping, treating, and heating water.

- Water closet with pressure assists technology  
This system traps air and as it fills with water, it uses the water supply line pressure to compress the trapped air inside. The compressed air is what forces the water into the bowl, so instead of the “pulling” or siphon action of a gravity unit, the pressure-assist unit “pushes” waste out. This vigorous flushing action cleans the bowl better than gravity units. This system uses 1.28 gallons per flush.
- Water less urinals  
Urinals will be fixed only for common toilets at the car park level. Still we encourage to use water efficient type fixtures. A typical urinal uses about 4-5 liters of water per

flush where newer models use lesser amount. Waterless urinals, on the other hand, use no water at all. These non-flushers have chemical traps that allow liquid waste to flow down a pipe without allowing sewer gases to escape. They do require daily cleaning (to minimize odor) with a mild acidic cleaner.



**Figure 10-10: Pressure assist technology and water less urinals**

- **Dual flush toilets**  
 Toilet does not need to be fully flushed in each and every time it is used. A dual flush toilet allows one to control how much water you flush each time and manage your overall water usage. Dual flush toilet can save up to 20% of water over a single flush unit of the same size.

Full flush = 6 liters

Half flush = 4.1 liters

With some basic calculations for the whole building it was found that if we are using single flush toilets the water requirement for flushing only will be 14.54m<sup>3</sup>/day and with dual flush toilet system this can be reduced by 21%.

Water Closet	No per apartment	No of users with maid	No of times used per person	Water requirements						
				Single flush (l)		Dual Flush (l)				
				per single use	Total Quantity	half use	quantity	full	quantity	Total Quantity
2 bed room	3	4	3	6.06	72.68	4.16	33.31	6.06	24.23	57.54

apartm ent										
3 bed room apartm ent	3	6	3	6.06	109.02	4.16	49.97	6.06	36.34	86.31
Total cubic metres of flushing water per building per day					<b>14.54</b>					<b>11.51</b>

**Table 10-4: Comparison of the water requirement with dual flush and single flush toilets**

➤ Water efficient shower head

The amount of water we use in a bath depends on the type of shower and shower head we have, and how long one spends in the shower. Shower heads controls the flow and spray pattern of water. We use “Aerating shower heads” mix water with air, reducing the overall amount of water that’s needed.

They will feature,

- Spring loaded, Self-cleaning Spray Disk to prevent particle clogging
- Cone-within-a-cone, Spray Pattern for total body coverage
- Saves up to 20% or more water depending on the length of shower
- Fast drain feature to prevent residual slow dripping

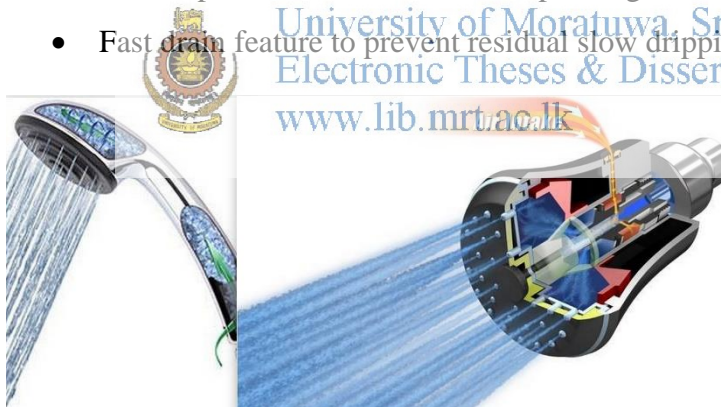

**Figure 10-12: Aerating shower heads**



**Figure 10-11: A Tap with Automatic Sensors**

- Automatic sensor faucets

The main purpose of using automatic sensor faucets is to reduce amount of water use (unnecessarily) in hand washing. But it also other benefits as well. It is said that it will reduce the water usage by about 90%. It helps to prevent the transmission of germs since no physical contact with the appliance is required to operate it.

### 10.3. Energy and Atmosphere

In any building project, proper management of energy is the golden key to score points in the LEED Certification system since total of 38 points are allocated to it. (Ref: <http://blueberrypdx.com/leed-point-flow-charts.htm#ea>) It ironically implies the importance of optimization of energy in making a project sustainable.

#### 10.3.1. Insulation, Air Infiltration and Windows (max. points: 2+3+3)

Climate controlled or Air conditioned apartments results in a large portion of the electricity bill for air conditioning monthly. To optimize the usage of A/C, proper insulation of the building is very essential. To improve the insulation of the building we have looked towards the use of thermal insulation and concrete of the building, selection of window to wall ratio, light availability and use of different types of glass.

Depending on the **orientation of the building**, the apartments in the Southern and Western sides of the building are expected to have bigger problems from direct sunlight. The height of the building restrains the ability to maintain a green façade outside the walls of these directions, which is a greener solution as an insulator.

External walls will be constructed with **Cement Stabilized Earth Blocks (CSEB)**. Due to the size of earth blocks, they have a high thermal mass. (Thermal mass is the ability of a material to absorb heat energy.) These earth blocks act as a thermal battery and can delay heat flow through a building envelope by as much as 10 - 12 hours (thermal lag). So, in a tropical country like Sri Lanka, we can have good thermal comfort in both day and night by using these blocks. In materials section more details about this product are discussed. To make use of the breathing action of bricks, they will be exposed inside of the walls and outside will be covered with a weather resisting paint. The embodied energy of this arrangement is much lower than the previous concrete arrangement. In insulation point of view also, earth blocks are better. So, we go with it.



**Figure 10-13: A CSEB block (left) and a building constructed with them (right)**

Windows and doors comprise a large part of the exterior building envelope.

**Window to wall ratio** will be 20%-30% to get a balance of maximum day light and with less cooling energy for AC.

When we consider the installation and maintenance costs and recyclable qualities, the final choice of material for window frames is the aluminium. It is strong and durable as well. However there is a considerable effect on the insulation when we use aluminium, since thermal conductivity of it is higher than wood.

The **U factor** of the windows will be lower than 0.6. This can be achieved by having double glassed windows with 1/2 inch air space and a low e-coating of 0.2 emittance ( for a 3'x5' window).

GLAZING TYPE	Visible Transmittance		Solar Heat Gain Coefficient	
	Glass only	Total Window	Glass only	Total Window
Single glass, clear	0.9	0.66	0.86	0.66
Double glass, clear, 1/2-inch air space	0.81	0.59	0.76	0.59
Double glass, clear, e= 0.2 air space 3/4 inches	0.76	0.55	0.65	0.51
Double glass, spectrally selective, e = 0.04*, 1/2-inch argon space	0.72	0.52	0.4	0.33

**Table 10-5: Properties of different double glazing windows**

Visible Transmittance or Visible Light Transmittance (VLT), is a measure of how much light passes through a window assembly. We need to choose a **VLT value closer to 0.50** for most of our windows to maximize the day lighting opportunities (which in turn reduces energy needed to run electric lights) and minimize glare.

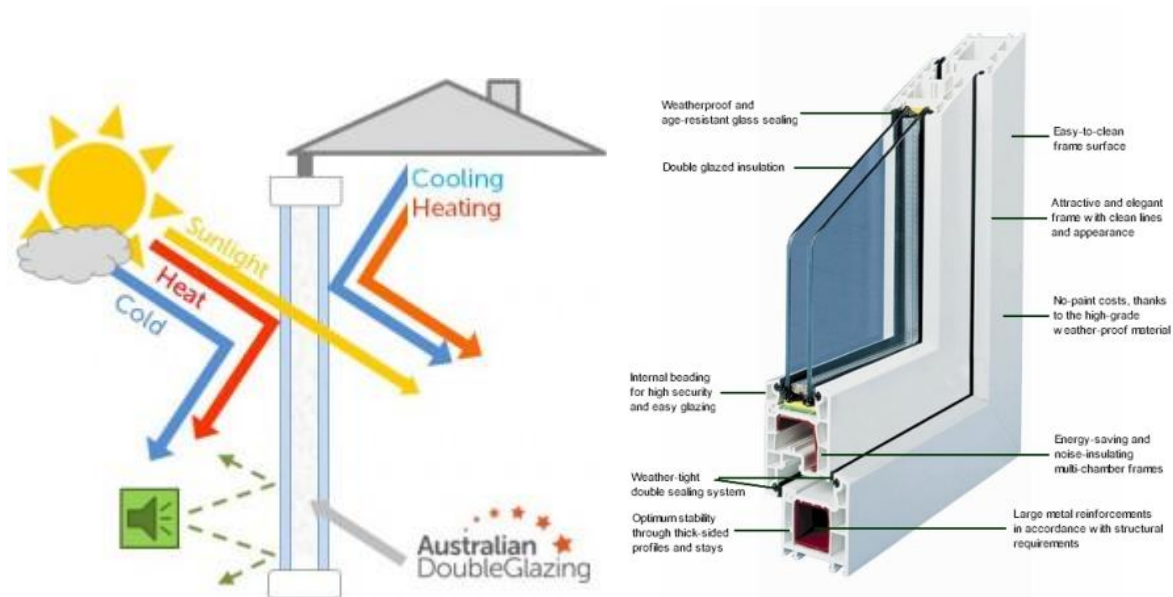

**Figure 10-14: Double glazing windows**

Again the selected window type fulfil the requirements imposed by the type and location of our building. No surrounding buildings have shadows on our building. *And for the convenience it is recommended to use this type of windows in all apartments without considering the orientation of the apartment.* University of Moratuwa, Sri Lanka.

**Air leakages** is also a big contributor for the problems in insulation, especially from doors and windows. There for we have used **casement type windows** as much as possible. The window will also be properly sealed into the window opening to maintain the air leakage resistance of the window to wall interface.

Exterior shading is more effective than interior shadings in reducing solar heat gain because they block radiation before it passes through a window. So, we will encourage residents to grow small trees on their balconies in easily maintained baskets. And by having **greener balconies** they will have a pleasant environment as well as improved insulation. By having a green covering on the balconies, we can reduce the effect of “thermal bridging” at balconies.

The interior walls will be made out of **durra panels**. This will be an innovative design, with extremely greener material which has very low thermal conductivity. So the heat loss from on room to another, inside the apartment will also be minimized.

### **10.3.2. Lighting (max. points: 3)**

Energy used for lighting in buildings can account for 40 to 50 percent of total energy consumption. In addition, the added space-cooling loads that result from waste heat generated by lights can amount to three to five percent of total energy use. Greater use of daylight can

provide advantages for the environment by reducing power demand and the related pollution and waste byproducts from power production.

- **Maximum daylight:** The final building envelop of Sky Residencies is designed to harness maximum natural daylight for each and every room of the apartments. Therefore it is expected a reduction of over 80% of electricity usage at day time. Common circulation areas are natural day lit and naturally ventilated through integration of skylights and ventilators.
- **Most of the interior lighting work with LED bulbs** The energy consumption of the LED bulb saves 30-40% energy than CFL bulbs or Fluorescent tubes and much more than incandescent bulbs. They produce less heat, much efficient, Environment friendly and have high life expectancy.



**Figure 10-15: The visual comparison above shows how well LED lights compare with other light sources**

	Incandescent	CFL	LED
<b>Watts consumed (to achieve equivalent brightness) (W)</b>	75	15	10
<b>Temperature (<sup>0</sup>F)</b>	335	131	87
<b>Lumens per Watt</b>	14	65	85
<b>Avg. lifespan (hours)</b>	1000	10,000	45,000
<b>Avg. cost per bulb (Rs)</b>	75 (Phillips)	460 (Orange)	2000 (LG)
<b>Annual operating cost (operating 6h per day)</b>	3927.75	755.55	503.7
<b>Life time Cost (Rs/h)</b>	3.32	0.12 (27 times less)	0.079 (42 times less)

**Table 10-6: A comparison of the lifetime cost of different types of bulbs**

- **Energy-efficient technology for lamps fixtures, and control equipment**

The greatest benefits of energy-efficient lighting are those resulting from effective lighting control. We are intended to use LED supported dimmers and switches, to control the lighting intensity according to the requirement of the users.

- **Improve room-cavity optics.**

The use of smooth, high-reflectance surfaces can greatly improve the efficiency of natural and artificial lighting. Therefore we use:

- Light- or neutral-colored surfaces to improve reflected light
- Fine-fissured ceiling tiles with a smooth, reflective surface
- Light colored shelves/ Furniture for introduction and control of natural light

- **Outdoor lighting**

Outdoor lighting is not so significant for a building with less gardening or road facilities. They should be provided to satisfy safety and comfort ability requirements.

But still we hope to use LED street lamps with fixtures to perform with best lighting for the ground.



University of Moratuwa, Sri Lanka.  
Electronic Theses & Dissertations  
[www.lib.mrt.ac.lk](http://www.lib.mrt.ac.lk)



**Figure 10-16: Efficient Exterior Lighting**

- **Ensuring proper maintenance of lighting equipment**

In the operational stage, proper maintenance scheme should be carried out. Starters and ballasts of lamps should be checked regularly and replaced if necessary.



### 10.3.3. Renewable Energy (max. points: 10)

According to the Wikipedia, “Renewable energy is generally defined as energy that comes from resources which are naturally replenished on a human timescale such as sunlight, wind, rain, tides, waves and geothermal heat.” Depending on the location and orientation of the building the most productive and reliable renewable energy source is the solar power to generate profitable amount of electricity using in Photovoltaic (PV) technology for Sky Residencies, Rajagiriya.



Photovoltaic (PV) technology is the direct conversion of sunlight to electricity using semiconductor devices called solar cells. Photovoltaic are almost maintenance-free and seem to have a long life span. The photoelectric conversion process produces no pollution and can make use of free solar energy. Overall, the longevity, simplicity, and minimal resources used to produce electricity via PV systems make this a highly sustainable technology.

We use net-metered PV panel system.

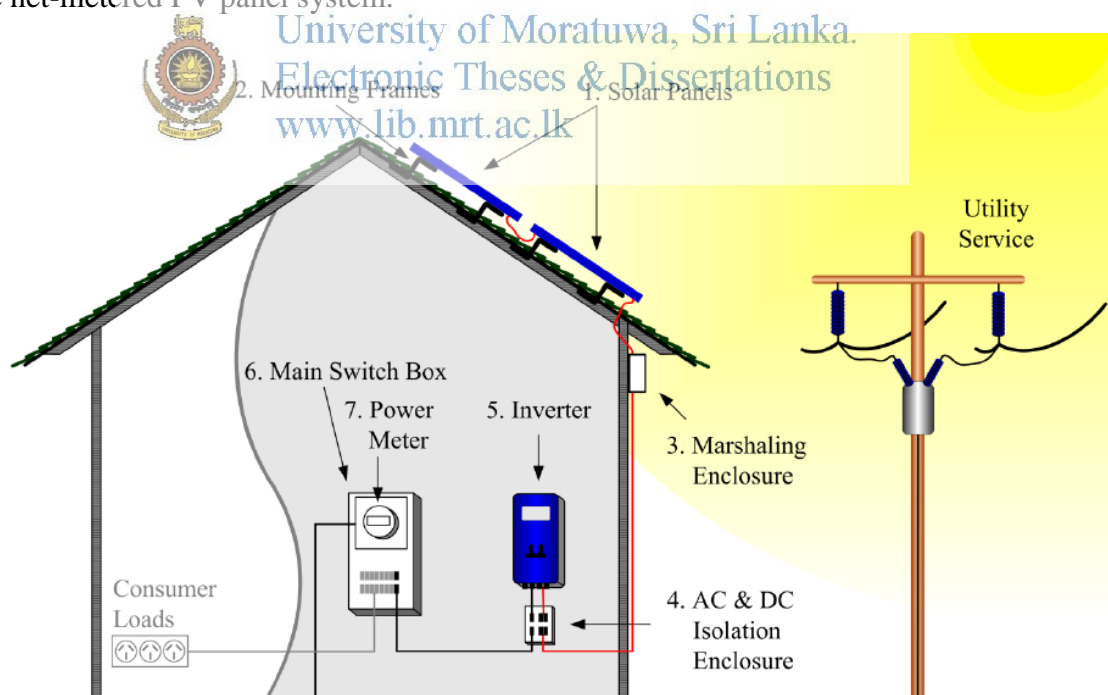

**Figure 10-17: Schematic overview of a Grid Connected Solar PV power system**

System lifetime	25 years
Tilt Angle	7° with horizontal
Orientation Angle	Southern direction.

Shading	No partial shading is allowed (located at the topmost place of the building)
Soiling of the Panels	Routine maintenance should eliminate the dirt films deposited on panels
Temperature	Provide sufficient space at the back of the panel to dissipate heat (rise in temperature by 10°C lowers the effective power output by 4%-5%)
Effective Area of the solar roof (sq. meters)	371
Area of a panel (sq. meters)	1.7
Power output from a single panel (kWp)	0.25
Location: Latitude	6°54'41.36"N
Location: Longitude	79°54'18.29"E
Average Solar radiation (kWh/m <sup>2</sup> /day)	5
No of Panels possible	218
DC Rating (kW)	54.5
AC Rating (kW)	44.7
Units of Electricity which can be generated in a typical sunny day (kWh/day)	190
Per year cost saving (Rs.23.00 per unit)	Rs 1,596,204.31
Construction cost	Rs 11,177,488.00
Interest Rate	8%
No of years to NPV to get positive	11 years

**Table 10-7: System Performance**

## 10.4. Materials and Resources

### 10.4.1. Reduction in waste during construction (max. 3 points)

We have to ensure maximum resource recovery and safe disposal of wastes generated during construction, and to reduce the burden on the landfill. In the construction stage and also in the operational stage we can expect several wastes such as cardboard, paper, metal, Brick, Concrete, Plastic, Glass, wood, insulation materials, and Mineral fiber panel. So, while managing these waste materials we have to,

- Employ measures to segregate the waste on-site into inert, chemical or hazardous wastes  
Provide location at the site for segregated collection of recyclable materials.
- Reuse/Recycle the segregated waste and unused chemical/ hazardous wastes such as oil, paint and batteries.
- Inert waste to be disposed to the municipal corporation/local bodies at landfill sites.

### 10.4.2. Material Reuse (max. 3 points)

In most cases re-using materials are more economical and environmental friendly than using virgin materials.



- At the construction stage we try to reduce the waste by reusing the wood and plywood pieces to the optimum level.
- Recyclable materials will be promoted (e.g. Steel Formwork, Aluminium window frames)
- Demolished concrete may use as fill material considering the suitability.

### 10.4.3. Materials Selection with Less Embodied Energy (Max. Points: 8)

Building Element	Material	Embodied Energy	(Unit)	CO2 Emissions (kg of CO2 / kg)
External Walls	Burnt Clay Bricks (9")	1173	MJ/m2	0.24
	Cement Hollow Block	364.72	MJ/m2	0.07
	<b>CSEB</b>	<b>145.13</b>	<b>MJ/m2</b>	<b>0.038</b>
Partitions	Brick Work	3	MJ/kg	0.24
	Plaster Board	6.75	MJ/kg	0.38
	<b>Durra Panels</b>	<b>0.91</b>	<b>MJ/kg</b>	<b>0.02</b>
Floor Finishes	PVC Flooring	65.64	MJ/kg	2.290
	<b>Tiles</b>	<b>12</b>	<b>MJ/kg</b>	<b>0.744</b>
Internal Roads	Asphalt Concrete	2.41	MJ/kg	0.14
	<b>Cement Stabilized Soil</b>	<b>0.31</b>	<b>MJ/kg</b>	<b>0.03</b>

**Table 10-8: Embodied Energy comparison of the possible materials**

However we had to select Aluminium window frames, neglecting the fact that it possess high embodied energy than wood or PVC frames. (Al frame: 5470 MJ/m2, PVC Frame: 2310 MJ/m2, Timber: 360 MJ/m2) The main advantages of Al frame is it is recyclable. Lighter than wood and strong than PVC. Timber frames require more maintenance.

And we always promote the use of regional materials for the construction work, because that will reduce the transportation cost and helps to the development in regional community.

### 10.4.4. Indoor Environmental Quality

It is said that people spend about 90% of their life time at indoors. Thus the quality of the indoor environment is very important in many aspects. It has a significant influence on their health, productivity and efficiency etc... To maintain a better air quality inside the building it is needed to provide necessary ventilation systems and to provide proper smoke draw out systems from the places like kitchens of the apartments.

### 10.4.5. Low-Emitting Materials—Adhesives and Sealants (1

**point)**

All adhesives and sealants used on the interior of the building must comply with the VOC limits given in the LEED document. So we'll select the materials with low-VOC content and use them in construction activity. (ANNEX4: Permissible values of VOC from adhesives and sealants)

**10.4.6. Low Emitting Materials – Paints and Coatings (1 point)**

Paints and coatings applied to interior walls and ceilings, anti-corrosive paints applied to interior metal surfaces, wood finishes, and floor coatings will not exceed the limits which are provided by the US Green building council.

Since we use CSEB external walls and Durra panels for internal walls, the requirements for paints and coatings is minimum. However internal partitions will be erected with durra panels which will be painted with low emitting paints. (ANNEX4: Permissible values of paints and coatings)



**10.4.7. Low Emitting Materials – flooring Systems (1 point)**

Whole building will have tiled floors and tiling adhesives will satisfy the VOC limits of sealants and adhesives prescribed. We don't use carpets considering the emission and dust problems and granite is not used considering the radon problems.

**10.4.8. Furnishings and Equipment.**

These items may emit odor, particles, and volatile organic compounds (VOCs), and adsorb and desorb VOCs. So we have to be careful about the material which those appliance are made of. The other problem is the glued panels. It is better to select furniture with less glued panels. No synthetic materials will be used for curtains and promote cotton and natural fabric curtains.

**10.4.9. Vehicle Emission Protection (Max. Points: 3)**

- Gases emitted from vehicles (especially in car park) area can cause lot-of health and safety problems.
- We have designed our five storied car park with ample openings to circulate air with outside. The planned green wall will only cover those openings partly so that spray at a

rainy situation will not come into the building. But majority of the space will be kept open.

- And we hope it would be helpful to reduce the emission level with promoting green energy cars (electric cars).

## 10.5. Innovation and Design

Here we'll highlight the innovative designs, concepts and features adopted in the building, which are beneficial to all stakeholders of the project.

- **No transfer floor is used**

In most high-rise apartment buildings in Sri Lanka which have a multistory car park in the lower floors of the building, we can see a transfer plate is used at the start of the general shape of the building. Having a transfer plate in the building increases the time to construct that particular floor and drastically increase the cost of construction. So we designed our building with innovative column arrangement which starts from car-park level and rises all the way up to the roof top, where we do not need a transfer plate to be installed. Those rectangular columns in this design can function as walls also.

- **Cantilevered Balconies**

Cantilevered balconies helps to reduce the construction cost with the reduction of cost to the supporting columns. Engineered structural thermal breaks will be used to stop the thermal bridging through these balconies into the building.

- **Roof top Solar Electricity Power Generation**

Solar power generation in multi-storey residential buildings are not common. Still we have successfully planned to have a PV power system on the top of the roof which has the power of 50kW.

## 10.6. Awareness and Education

Irrespective of the effort we put into the design and construction of the building project with ample sustainable features, they will function poorly if we do not improve the awareness among users and management staff about those features and how to maintain them to have a longer life. Therefore it is always important to have a "Homeowner's manual" covering the operation and maintenance of green features of the building. Therefore these are the suggestions we have identified to use in improving the awareness and education.

- Provide an owner's manual for each buyer

- Conduct routine awareness campaigns for both residence and the service staff, time to time, conducted by the management staff of the building



University of Moratuwa, Sri Lanka.  
Electronic Theses & Dissertations  
[www.lib.mrt.ac.lk](http://www.lib.mrt.ac.lk)

## 11. BILL OF QUANTITY

### 11.1. Introduction

Sri Lanka Standard 573:1999 Method of Measurement of Building Works is used for the calculations. Quantities were estimated using building drawings and BSR issue 2013 was used as a base for unit rate estimation.

### 11.2. Grand Summary of BOQ

<b>GRAND SUMMARY</b>		
<b>BILL NO.</b>	<b>DESCRIPTION</b>	<b>AMOUNT</b>
1	Preliminaries	Rs. 138,148,000.00
2	Site Preparation	Rs. 295,500.00
3	Excavation and Earthwork	Rs. 587,000.00
4	Piling	Rs. 34,907,757.93
5	Concrete work	Rs. 1,326,676,638.49
6	Masonry Work and Walls	Rs. 66,750,903.07
7	Finishes	Rs. 941,347,060.20
8	Lift Arrangement	Rs. 9,240,000.00
9	Water Supply and Fittings	Rs. 20,420,918.32
10	Drainage System	Rs. 8,248,673.11
11	Electrical System	Rs. 40,914,462.00
12	Provisional Sums	Rs. 501,380,622.40
	<b>Grand Total</b>	<b>Rs. 3,088,917,412.30</b>
	Add: Contingencies (5%)	Rs. 154,445,876.78
	<b>Total With Contingencies</b>	<b>Rs. 3,243,363,412.30</b>
	Add: 12% VAT	Rs. 389,203,609.48
	<b>GRAND TOTAL WITH CONTINGENCIES &amp; VAT</b>	<b>Rs. 3,632,567,021.77</b>



### 11.3. Detailed Bill of Quantity

Item	Description	Unit	Quantity	Rate	Amount
<b>1. PRELIMINARIES</b>					
1.1	Facilities/ Temporary works/services such as Offices, Sanitary accommodation, Temporary fences, Telephone, surveying equipment and salaries of management	Item	1		Rs. 128,748,000.00
1.2	Maintain Public and Private roads	Item	1		Rs. 2,000,000.00
1.3	Hoisting plants (fixing and maintenance)	Item	1		Rs. 4,000,000.00
1.4	Temporary roads and maintenance	Item	1		Rs. 2,000,000.00
1.5	Scaffolding and supports	Item	200	7000.00	Rs. 1,400,000.00
<b>2. SITE PREPARATION</b>					
2.1	Site preparation, Clearing site vegetation, removing bushes, shrubs & top soil to a depth not exceeding 6" and removing all debris away from site.	m2	300	985.00	Rs. 295,500.00
<b>3. EXCAVATION AND EARTHWORK</b>					
3.1	Manual excavation site preparation for piling platform preparation	m3	200	850.00	Rs. 170,000.00
3.2	Disposal of surplus excavated material away from site as directed	m3	250	300.00	Rs. 75,000.00
<b>TERMITE TREATMENT</b>					
3.3	Approved termite treatment below basement slab as per specification and approval of the Engineer	m2	1900	180.00	Rs. 342,000.00

4. PILING					
4.1	Mobilization & De-mobilization of Pile Drilling Rigs, Support cranes, Bentonite tanks Drilling Tools & Accessories. Welding Plants & equipment as necessary	item	1		Rs. 800,000.00
4.2	Surveying and ground preparation	item	1		Rs. 600,000.00
4.3	Boring of pile	item			Rs. 9,400,000.00
4.4	Concrete of G30 with admixtures	m3	1339.881	17220.00	Rs. 23,072,757.93
4.5	Pile hacking and cleaning the debris	item	69	15000.00	Rs. 1,035,000.00
5. CONCRETE WORK					
<u>SUB-STRUCTURE</u>					
5.1	Lean Concrete on top of piles Under pile cap	m3	80.73825	16085.00	Rs. 1,298,674.75
5.2	Pile Cap and Pile raft				
5.3	Reinforced concrete of G40 with admixtures	m3	1184.161	17800.00	Rs. 21,078,065.80
<u>SUPER-STRUCTURE</u>					
<u>Ground floor to 5th level Car Park</u>					
5.4	Columns Concrete G 30 and mixed with integral waterproofing admixture, maximum aggregate size 20mm in the following ;	note			

5.5	In lift and shear walls( 200mm and 300mm) G40	m3	273.408	17800.00	Rs.	4,866,662.40
5.6	In columns G40	m3	332.45	17800.00	Rs.	5,917,610.00
5.7	In Beams G35	m3	407.45	17220.00	Rs.	7,016,289.00
5.8	In Slab 150mm	m3	1087.788	17945.00	Rs.	19,520,355.66
5.9	In staircase waist and steps	m3	18	17220.00	Rs.	309,960.00
5.10	In Landings	m3	6.75	17220.00	Rs.	116,235.00
	<b><u>Recreational floor Level 6</u></b>					
5.11	In lift and shear walls( 200mm and 300mm) G40	m3	68.352	17800.00	Rs.	1,216,665.60
5.12	In columns G40	m3	63.525	17800.00	Rs.	1,130,745.00
5.13	In Beams G35	m3	133.205	17220.00	Rs.	2,293,790.10
5.14	In Slab 150mm	m3	271.947	17945.00	Rs.	4,880,088.92
5.15	In staircase waist and steps	m3	4	17220.00	Rs.	68,880.00
5.16	In Landings	m3	1.35	17220.00	Rs.	23,247.00
5.17	Lintels					
	<b><u>Apartment Zone1 level 7-10</u></b>					
5.18	In lift and shear walls( 200mm and 300mm) G40	m3	273.408	17800.00	Rs.	4,866,662.40
5.19	In columns G40	m3	227.7	17800.00	Rs.	4,053,060.00
5.20	In Beams G35	m3	215.971	17220.00	Rs.	3,719,020.62
5.21	In Slab 150mm	m3	505.8	17945.00	Rs.	9,076,581.00
5.22	In staircase waist and steps	m3	14.4	17220.00	Rs.	247,968.00
5.23	In Landings	m3	5.4	17220.00	Rs.	92,988.00
5.24	In Lintels	m3	1.962	17220.00	Rs.	33,785.64
	<b><u>Apartment Zone1 level 11-30</u></b>					
5.25	In lift and shear walls( 200mm and 300mm) G40	m3	1367.04	18900.00	Rs.	25,837,056.00
5.26	In columns G40	m3	1138.5	18900.00	Rs.	21,517,650.00

5.27	In Beams G35	m3	1079.855	18320.00	Rs.	19,782,943.60
5.28	In Slab 150mm	m3	2529	19045.00	Rs.	48,164,805.00
5.29	In staircase waist and steps	m3	72	18320.00	Rs.	1,319,040.00
5.30	In Landings	m3	27	18320.00	Rs.	494,640.00
5.31	In lintels	m3	1.962	18320.00	Rs.	35,943.84
	<b><u>Apartment Zone1 level 31-46</u></b>					
5.32	In lift and shear walls( 200mm and 300mm) G40	m3	800.64	20000.00	Rs.	16,012,800.00
5.33	In columns G40	m3	910.8	20000.00	Rs.	18,216,000.00
5.34	In Beams G35	m3	863.884	20000.00	Rs.	17,277,680.00
5.35	In Slab 150mm	m3	2059.68	20000.00	Rs.	41,193,600.00
5.36	In staircase waist and steps	m3	57.6	20000.00	Rs.	1,152,000.00
5.37	In Landings	m3	21.6	20000.00	Rs.	432,000.00
5.38	In Lintels	m3	1.962	20000.00	Rs.	39,240.00
	<b><u>Formwork</u></b>					
	<b><u>SUB-STRUCTURE</u></b>					
5.39	<i>Pile Cap and Pile raft</i>	m2	884.18	1298.00	Rs.	1,147,665.64
	<b><u>Ground floor to 5th level Car Park</u></b>					
5.40	To columns	m <sup>2</sup>	2216.74	1704.00	Rs.	3,777,324.96
5.41	To beams	m <sup>2</sup>	3888.64	2015.00	Rs.	7,835,609.60
5.42	To slabs	m <sup>2</sup>	7251.92	1300.00	Rs.	9,427,496.00
5.43	To lift and shear wall	m <sup>2</sup>	1827.84	1500.00	Rs.	2,741,760.00
5.44	To lintels.	m <sup>2</sup>	322.88	1440.00	Rs.	464,947.20
5.45	To sides staircase and Landing	m <sup>2</sup>	20	1534.00	Rs.	30,680.00

	<b><u>Recreational floor Level 6</u></b>					
5.46	To columns	m <sup>2</sup>	488.95	1704.00	Rs.	833,170.80
5.47	To beams	m <sup>2</sup>	1270.845	2015.00	Rs.	2,560,752.68
5.48	To slabs	m <sup>2</sup>	1812.98	1300.00	Rs.	2,356,874.00
5.49	To lift and shear wall	m <sup>2</sup>	456.96	1500.00	Rs.	685,440.00
5.50	To lintels.	m <sup>2</sup>	52.32	1440.00	Rs.	75,340.80
5.51	To sides staircase and Landing	m <sup>2</sup>	20	1534.00	Rs.	30,680.00
	<b><u>Apartment Zone1 level 7-10</u></b>					
5.52	To columns	m <sup>2</sup>	1752.6	1874.40	Rs.	3,285,073.44
5.53	To beams	m <sup>2</sup>	3772	2216.50	Rs.	8,360,638.00
5.54	To slabs	m <sup>2</sup>	3372	1430.00	Rs.	4,821,960.00
5.55	To lift and shear wall	m <sup>2</sup>	2056.32	1650.00	Rs.	3,392,928.00
5.56	To lintels	m <sup>2</sup>	209.28	1584.00	Rs.	331,499.52
5.57	To sides staircase and Landing	m <sup>2</sup>	20	1687.40	Rs.	33,748.00
	<b><u>Apartment Zone1 level 11-30</u></b>					
5.58	To columns	m <sup>2</sup>	8763	2061.84	Rs.	18,067,903.92
5.59	To beams	m <sup>2</sup>	18860	2438.15	Rs.	45,983,509.00
5.60	To slabs	m <sup>2</sup>	16860	1573.00	Rs.	26,520,780.00
5.61	To lift and shear wall	m <sup>2</sup>	10281.6	1815.00	Rs.	18,661,104.00
5.62	To lintels.	m <sup>2</sup>	837.12	1742.40	Rs.	1,458,597.89
5.63	To sides staircase and Landing	m <sup>2</sup>	100	1856.14	Rs.	185,614.00
	<b><u>Apartment Zone1 level 31-46</u></b>					
5.64	To columns	m <sup>2</sup>	7010.4	2268.02	Rs.	15,899,755.45
5.65	To beams	m <sup>2</sup>	15088	2681.97	Rs.	40,465,487.92
5.66	To slabs	m <sup>2</sup>	13731.2	1730.30	Rs.	23,759,095.36

5.67	To lift and shear wall	m <sup>2</sup>	5966.208	1996.50	Rs.	11,911,534.27
5.68	To lintels.	m <sup>2</sup>	837.12	1916.64	Rs.	1,604,457.68
5.69	To sides staircase and Landing	m <sup>2</sup>	320	2041.75	Rs.	653,361.28
	<b>Reinforcement</b>					
	<b>SUB-STRUCTURE</b>					
5.70	<i>Pile Cap and Pile raft</i>	t	212.2032	203000.00	Rs.	43,077,249.60
	<b><u>SUPER-STRUCTURE</u></b>					
	<b><u>Ground floor to 5th level Car Park</u></b>					
5.71	Columns Concrete G 30 and mixed with integral waterproofing admixture, maximum aggregate size 20mm in the following ;	note				
5.72	In lift and shear walls( 200mm and 300mm) G40	t	65.61792	203000.00	Rs.	13,320,437.76
5.73	In columns G40	t	79.788	203000.00	Rs.	16,196,964.00
5.74	In Beams G35	t	97.788	203000.00	Rs.	19,850,964.00
5.75	In Slab 150mm	t	261.0691	203000.00	Rs.	52,997,031.36
5.76	In staircase waist and steps	t	4.32	203000.00	Rs.	876,960.00
5.77	In Landings	t	1.62	203000.00	Rs.	328,860.00
	<b><u>Recreational floor Level 6</u></b>					
5.78	In lift and shear walls( 200mm and 300mm) G40	t	16.40448	203000.00	Rs.	3,330,109.44
5.79	In columns G40	t	15.246	203000.00	Rs.	3,094,938.00
5.80	In Beams G35	t	31.9692	203000.00	Rs.	6,489,747.60

5.81	In Slab 150mm	t	65.26728	203000.00	Rs.	13,249,257.84
5.82	In staircase waist and steps	t	0.96	203000.00	Rs.	194,880.00
5.83	In Landings	t	0.324	203000.00	Rs.	65,772.00
5.84	Lintels					
<b><u>Apartment Zone1 level 7-10</u></b>						
5.85	In lift and shear walls(200mm and 300mm) G40	t	65.61792	203000.00	Rs.	13,320,437.76
5.86	In columns G40	t	54.648	203000.00	Rs.	11,093,544.00
5.87	In Beams G35	t	51.83304	203000.00	Rs.	10,522,107.12
5.88	In Slab 150mm	t	121.392	203000.00	Rs.	24,642,576.00
5.89	In staircase waist and steps	t	3.456	203000.00	Rs.	701,568.00
5.90	In Landings	t	1.296	203000.00	Rs.	263,088.00
<b><u>Apartment Zone1 level 11-30</u></b>						
5.91	In lift and shear walls(200mm and 300mm) G40	t	328.0896	203000.00	Rs.	66,602,188.80
5.92	In columns G40	t	273.24	203000.00	Rs.	55,467,720.00
5.93	In Beams G35	t	259.1652	203000.00	Rs.	52,610,535.60
5.94	In Slab 150mm	t	606.96	203000.00	Rs.	123,212,880.00
5.95	In staircase waist and steps	t	17.28	203000.00	Rs.	3,507,840.00
5.96	In Landings	t	6.48	203000.00	Rs.	1,315,440.00
<b><u>Apartment Zone1 level 31-46</u></b>						
5.97	In lift and shear walls(200mm and 300mm) G40	t	192.1536	203000.00	Rs.	39,007,180.80
5.98	In columns G40	t	218.592	203000.00	Rs.	44,374,176.00
5.99	In Beams G35	t	207.3322	203000.00	Rs.	42,088,428.48
5.100	In Slab 150mm	t	494.3232	203000.00	Rs.	100,347,609.60

5.101	In staircase waist and steps	t	13.824	203000.00	Rs.	2,806,272.00
5.102	In Landings	t	5.184	203000.00	Rs.	1,052,352.00
<b><u>6. MASSONARRY WORK AND WALLS</u></b>						
Note: Using CSEB for masonry work						
<b><u>Ground floor to 5th level Car Park</u></b>						
6.1	225mm walls - CSEB	m2	1883.2	1836.00	Rs.	3,457,555.20
<b><u>Recreational floor Level 6</u></b>						
6.2	225mm walls - CSEB	m2	289.692	1836.00	Rs.	531,874.51
6.3	Partition walls -Dura panels	m2	240.12	4214.00	Rs.	1,011,865.68
<b><u>Apartment Zone1 level 7-10</u></b>						
6.4	225mm walls - CSEB	m2	1158.768	1836.00	Rs.	2,127,498.05
6.5	Partition walls -Dura panels	m2	960.48	4214.00	Rs.	4,047,462.72
<b><u>Apartment Zone1 level 11-30</u></b>						
6.6	225mm walls - CSEB	m2	5739.84	1836.00	Rs.	10,637,490.24
6.7	Partition walls -Dura panels	m2	4802.4	4214.00	Rs.	20,237,313.60
<b><u>Apartment Zone1 level 31-46</u></b>						
6.8	225mm walls - CSEB	m2	4635.072	1836.00	Rs.	8,509,992.19
6.9	Partition walls -Dura panels	m2	3841.92	4214.00	Rs.	16,189,850.88
<b>7 FINISHES</b>						
<b>Plastering</b>						
<b><u>Ground floor to 5th level Car Park</u></b>						



7.1	Plastering 5/8" thick to walls in cement, lime or equivalent chemical product (Febmix) and sand 1:1:5 finished semi-rough with wooden float. (Sand to be sieved).	m2	1506.56	542.00	Rs.	816,555.52
7.2	Stair Cases	m2	64	812.00	Rs.	51,968.00
<b><u>Recreational floor Level 6</u></b>						
7.3	External Walls-Plastering 5/8" thick to walls in cement, lime or equivalent chemical product (Febmix) and sand 1:1:5 finished semi-rough with wooden float. (Sand to be sieved).	m2	289.692	542.00	Rs.	157,013.06
7.4	Internal Walls-dura boards	m	44.4	800.00	Rs.	35,520.00
7.5	Inside of the external walls	m2	289.692	698.00	Rs.	202,205.02
7.6	Reveals	m	62	426.00	Rs.	26,412.00
7.7	Stair Cases	m2	16	812.00	Rs.	12,992.00
<b><u>Apartment Zone1 level 7-10</u></b>						
7.8	External Walls-Plastering 5/8" thick to walls in cement, lime or equivalent chemical product (Febmix) and sand 1:1:5 finished semi-rough with wooden float. (Sand to be sieved).	m2	1158.768	542.00	Rs.	628,052.26
7.9	Internal Walls-dura boards	m	266.8	800.00	Rs.	213,440.00
7.10	Inside of the external walls	m2	1158.768	698.00	Rs.	808,820.06
7.11	Reveals	m	204	426.00	Rs.	86,904.00
7.12	Stair Cases	m2	64	812.00	Rs.	51,968.00

	<b><u>Apartment Zone1 level 11-30</u></b>				
7.13	External Walls-Plastering 5/8" thick to walls in cement, lime or equivalent chemical product (Febmix) and sand 1:1:5 finished semi-rough with wooden float. (Sand to be sieved).	m2	5793.84	542.00	Rs. 157,013.06
7.14	Internal Walls-dura boards	m	1334	800.00	Rs. 53,360.00
7.15	Inside of the external walls	m2	5793.84	698.00	Rs. 202,205.02
7.16	Reveals	m	1020	426.00	Rs. 21,726.00
7.17	Stair Cases	m2	320	812.00	Rs. 259,840.00
	<b><u>Apartment Zone1 level 31-46</u></b>				
7.18	External Walls-Plastering 5/8" thick to walls in cement, lime or equivalent chemical product (Febmix) and sand 1:1:5 finished semi-rough with wooden float. (Sand to be sieved).	m2	4635.072	542.00	Rs. 157,013.06
7.19	Internal Walls-dura boards	m	1067.2	800.00	Rs. 53,360.00
7.20	Inside of the external walls	m2	4635.072	698.00	Rs. 202,205.02
7.21	Reveals	m	816	426.00	Rs. 21,726.00
7.22	Stair Cases	m2	256	812.00	Rs. 207,872.00
	<b><u>Tiling and Rendering</u></b>				
	<b><u>Ground floor to 5th level Car Park</u></b>				

7.23	Rendering 1/2" thick in cement and sand 1:2 in exposed concrete surfaces and garage floors finished smooth with colour pigment. ( Pigment added at 2.5 Kg / Sqr )	m2	9064.9	609.00	Rs.	5,520,524.10
	<b><u>Recreational floor Level 6</u></b>					
7.24	Homogeneous vitreous porcelain rectified floor tile 24" x 12" paving on 1:3 cement & sand bedding and pointed with tile grout to match the tile. ( Heavy duty ) (Prime Cost of tile Rs.475.00)	m2	1812.98	4260.00	Rs.	7,723,294.80
	<b><u>Apartment Zone1 level 7-46</u></b>					
7.25	Homogeneous vitreous porcelain rectified floor tile 24" x 12" paving on 1:3 cement & sand bedding and pointed with tile grout to match the tile. ( Heavy duty ) (Prime Cost of tile Rs.475.00)	m2	72519.2	5200.00	Rs.	377,099,840.00
	<b><u>Painting</u></b>					
	<b><u>Ground floor to 5th level Car Park</u></b>					
7.26	Internal Painting	m2	22747.83	1980.00	Rs.	45,040,693.50
7.27	External Painting	m2	1883.2	2480.00	Rs.	4,670,336.00
	<b><u>Recreational floor Level 6</u></b>					
7.28	Internal Painting	m2	2464.27	1980.00	Rs.	4,879,254.60
7.29	External Painting	m2	1670.842	2480.00	Rs.	4,143,688.16
	<b><u>Apartment Zone1 level 7-46</u></b>					

7.30	Internal Painting	m2	113356.4	1980.00	Rs. 224,445,711.60
7.31	External Painting	m2	76858.73	2480.00	Rs. 190,609,655.36
	<b><u>Ceiling Paint</u></b>				
7.32	ground to 5th level	m2	9064.9	480.00	Rs. 4,351,152.00
7.33	level 6 to 46	m2	34563	1980.00	Rs. 68,434,740.00
<b>8. LIFT ARRANGEMENT</b>					
8.1	12 Capacity Lifts including fixing cost	Nr	2	1980000.00	Rs. 3,960,000.00
8.2	28 Capacity Lifts including fixing cost	Nr	2	2640000.00	Rs. 5,280,000.00
<b>9. WATER SUPPLY AND FITTINGS</b>					
9.1	Supplying laying and/or fixing 1/2" dia. P.V.C. pipes Type 1000 (Specials paid separately)	m	1718.10	164.00	Rs. 281,768.40
9.2	Supplying laying and/or fixing 2" dia. P.V.C. pipes Type 1000 (Specials paid separately).	m	327.20	803.60	Rs. 262,937.92
9.3	Supplying and fixing 1/2" dia. PVC Elbow	Nr.	577.00	48.00	Rs. 27,696.00
9.4	Supplying and fixing 1/2" dia. PVC Valve Socket	Nr.	1104.00	53.00	Rs. 58,512.00
9.5	Supplying and fixing 2" - 1/2" 2 dia. PVC. Reducing Tee.	Nr.	92.00	274.00	Rs. 25,208.00
9.6	Supplying and fixing 1/2" dia. PVC Equal Tee	Nr.	966.00	53.00	Rs. 51,198.00
9.7	Supplying and fixing 2" dia. PVC Valve Socket	Nr.	14.00	197.00	Rs. 2,758.00
9.8	Supplying and fixing 2" dia. PVC Elbow	Nr.	20.00	250.00	Rs. 5,000.00
9.9					
9.10	Supplying and fixing Health faucet (Bidet Spray)	Nr.	368.00	575.00	Rs. 211,600.00

9.11	Supplying and fixing 1/2" Pillar Sink tap (Swan-neck tap)	Nr.	368.00	950.00	Rs.	349,600.00
9.12	Supplying and fixing Shower.	Nr.	184.00	610.00	Rs.	112,240.00
9.13	Wash Basin with Pedestal	Nr.	368.00	15670.00	Rs.	5,766,560.00
9.14	Close Couple Dual Flush Water Closet	Nr.	368.00	19195.00	Rs.	7,063,760.00
9.15	Urinals	Nr.	184.00	7620.00	Rs.	1,402,080.00
9.16	Water sump	Nr.	6.00	800000.00	Rs.	4,800,000.00
	<b>10. DRAINAGE SYSTEM</b>					
10.1	Supplying and fixing 2" dia. P.V.C waste pipe (type 600)	m	575.18	590.40	Rs.	339,588.63
10.2	Supplying and fixing 4" dia. P.V.C waste pipe (type 600)	m	901.60	1672.80	Rs.	1,508,196.48
10.3	Supplying and fixing 4" dia. PVC Elbow	Nr.	216.00	2696.00	Rs.	582,336.00
10.4	Supplying and fixing 4" dia. PVC Equal Tee	Nr.	368.00	3332.00	Rs.	1,226,176.00
10.5	Supplying and fixing 2" dia. PVC Elbow	Nr.	184.00	250.00	Rs.	46,000.00
10.6	Supplying and fixing 2" dia. PVC Equal Tee	Nr.	92.00	303.00	Rs.	27,876.00
10.7	Supplying and laying 6" dia.P.V.C. sewer pipes (type 600) Including cement concrete surrounding 1:3:6:	m	115.00	1760.00	Rs.	202,400.00
10.8	Concrete sewer manholes	Nr.	10.00	20970.00	Rs.	209,700.00
10.9						
10.10	Construction of 150 person RCC Septic tank soil including necessary excavation.	Nr.	5.00	669420.00	Rs.	3,347,100.00
10.11	Construction of 8'-0" dia. soakage pit in loose soil including necessary excavation	Nr.	5.00	151860.00	Rs.	759,300.00
	<b>11. ELECTRICAL SYSTEM</b>					

11.1	Light points-wired through a 5Amp 5 gang one way plate switch using 2x1/1.13mm(2x1/044) P.V.C. insulated copper wire in fully concealed/surface P.V.C. conduits.	Per Point	3680.00	3820.00	Rs.	14,057,600.00
11.2	Light point wired through a 5Amp one gang two way plate switch using 2x1/1.13mm (2x1/044) P.V.C. insulated copper wire in fully concealed/surface P.V.C. conduits.	Per Point	460.00	2115.00	Rs.	972,900.00
11.3	Flush mounted 5 Amp Switch socket outlet wired using 2x1/1.13mm (2x1/044) P.V.C. insulated copper wire & 1x7/0.67(7/029) copper earth wire in fully concealed/surface P.V.C. conduits.	Nr.	4232.00	3205.00	Rs.	13,563,560.00
11.4	15 Amp switch socket outlet wired using 2x7/0.67(2x7/029) insulated copper wire & 1x7/0.67(7/029) copper earth wire in surface plastic casing and capping.	Nr.	368.00	4765.00	Rs.	1,753,520.00
11.5	14-16 ways SP&N distribution board with thermo plastic frame and door, earth and neutral bars din rail type (protection rating IP40)	Nr.	92.00	1925.00	Rs.	177,100.00
11.6	40 Amp Single Pole MCB	Nr.	2300.00	740.00	Rs.	1,702,000.00
11.7	60 Amp Four Pole Main Switch	Nr.	92.00	8840.00	Rs.	813,280.00
11.8	63Amp, 30 mA Four Pole ELCB (RCCB)	Nr.	70.00	9920.00	Rs.	694,400.00
11.9	4'-0" long single fluorescent lamp fitting, suspension - polished aluminium reflector with 1 no of 36W fluorescent bulb.	Nr.	5290.00	1165.00	Rs.	6,162,850.00

11.10	Main Supply of 60Amp Three phase from Ceylon Electricity Board or Lanka Electricity Company	Item	1.00	100000.00	Rs.	100,000.00
11.11	Supplying and wiring 4 x 95mm <sup>2</sup> PVC/PVC/Cu cable + 50 mm <sup>2</sup> earth wire complete to working order excluding conduit/casing.	m	70.00	13103.60	Rs.	917,252.00
<b>12. PROVISIONAL SUMS</b>						
12.1	Allow Provisional sum for External Works	Item			Rs.	20,000,000.00
12.2	Installation of Water treatment Plant	Item			Rs.	6,000,000.00
12.3	Supply and installation of transformer	Item			Rs.	9,000,000.00
12.4	Supply and installation of generator	Item			Rs.	17,400,000.00
12.5	Telephone and Data Cable system	Item			Rs.	4,300,000.00
12.6	Solar System	Item			Rs.	20,321,200.00
	Supply and installation of Grid connected Solar system including solar modules, invertors, cabling work, Structural steel roof trusses for solar panel and all other necessary works.					
12.7	INTERCOM SYSTEM	Item			Rs.	900,000.00
	Supply and installation of 46 No's phones and all other accessories including cabling.					
12.8	CCTV SYSTEM	Item			Rs.	1,560,000.00

	Supply and installation of 12 No's CCTV cameras, DVR and all other accessories including cabling.				
12.9	BMS SYSTEM	Item			Rs. 8,100,000.00
	Supply and installation of BMS System to monitor major parts of Electrical System, AC System , Fire System , Transport System and Plumbing system.				
12.10	ACCESS CONTROL SYSTEM	Item			Rs. 2,160,000.00
	Supply and installation of Access control system to the entrance				Rs. -
12.11	Curtain walls , Glazed Doors, Balconies, Recreational area work, Hallway work, Pool, Gym and Furnishing	Item			Rs. 151,891,535.40
12.12	Aluminium Doors and Windows and Other Aluminium Work	Item			Rs. 259,747,887.00
	<b>TOTAL</b>				<b>Rs. 3,632,567,021.77</b>



## APPENDICES



University of Moratuwa, Sri Lanka.  
Electronic Theses & Dissertations  
[www.lib.mrt.ac.lk](http://www.lib.mrt.ac.lk)