

**REACTIVE POWER DISPATCH BY DISTRIBUTED  
GENERATORS THROUGH STEP LOAD FLOW  
SIMULATION AND GENETIC ALGORITHM**

A.M.G.G.S.H.B. Abeysinghe

118551T

Degree of Master of Science

Department of Electrical Engineering

University of Moratuwa

Sri Lanka

May 2016

**REACTIVE POWER DISPATCH BY DISTRIBUTED  
GENERATORS THROUGH STEP LOAD FLOW  
SIMULATION AND GENETIC ALGORITHM**

A.M.G.G.S.H.B. Abeysinghe

118551T

Thesis/Dissertation submitted in partial fulfillment of the requirements for the degree  
of Master of Science in Electrical Engineering

Department of Electrical Engineering

University of Moratuwa

Sri Lanka

May 2016

## **DECLARATION OF THE CANDIDATE & SUPERVISORS**

“I declare that this is my own work and this thesis/dissertation does not incorporate any material previously submitted for a Degree or Diploma in any other University or institute of higher learning to the best of my knowledge and belief. It does not contain any material previously published or written by another person except where the acknowledgement is made in the text.

I hereby grant to University of Moratuwa the non-exclusive right to reproduce and distribute my thesis/dissertation, in whole or in part in print, electronic or other medium. I retain the right to use this content in whole or part in future works (such as articles or books).

.....

Signature

.....

Date

The above candidate has carried out research for the Masters thesis/  
Dissertation under my supervision.

.....

Signature of the supervisor

(Prof. J.R. Lucas)

.....

Date

.....

Signature of the supervisor

(Dr. H.M. Wijekoon)

.....

Date

## ACKNOWLEDGEMENTS

It is with deepest sense of gratitude, I acknowledge the tremendous encouragement, guidance and support extended to me by my supervisors Prof. J.R. Lucas and Dr. H.M. Wijekoon.

I extended my sincere gratitude and thanks to all lectures of the Department of Electrical Engineering, University of Moratuwa for providing all the necessary facilities and guidance for all our academic activities.

I would specially like to appreciate the support provided by Ceylon Electricity Board for allowing me to following this MSC and to collect data and information from relevant branches.

I would further like to thank the senior engineers Mr. Eranaga Kudahewa and Mr. Amila Wijethunga and my friends Mr. Jagath Samarawickrama, Mr. Dinesh Disanayaka and Mrs. Erandhi Hemachandra for the support provided by them in numerous ways throughout this period.

I thank all personnel who gave their ideas, support and encouragement.

Finally, I owe my gratitude to my father, mother and my two brothers for their endless support and encouragement, and without them I would not have come this far.

A.M.G.G.S.H.B.Abeysinghe

## ABSTRACT

Demand for reactive power in a transmission and distribution network is met by various ways such as through power generating plants, compensation by means of capacitors at the utility grid and compensation at the load point through capacitors etc. In CEB utility grid, most of the reactive power requirement is supplied by the grid via transmission and distribution network from major generating stations. This leads to increase of transmission and distribution network current, thereby increasing real power loss in the system

This can be avoided by producing required amount of reactive power closer to the load centers. Possibly, economical reactive power generation can be done at medium voltage systems. Medium voltage system consist of many distributed generators such as diesel generators, wind power generators, bio mass plants and mini hydro plants etc. Due to inconsistency of water inflow in Mini Hydro plants, they do not run at full load throughout the day. Thereby, Mini Hydro plants can be utilized to compensate reactive power requirement in the medium voltage level while meeting their primary objective of generating real power.

Generating reactive power from several mini hydro plants, while reducing losses at the power system is a complex optimization task. In this research Genetic Algorithm was used to solve above optimization problem and simulated in SynerGEE and Matlab software.

Results of this research is focused on developing a scheme to dispatch reactive power to the grid through Mini Hydro plants while reducing losses at the distribution system and meeting its primary objective of providing real power from the same Mini Hydro plants.

**Key words** Genetic Algorithm, Mini Hydro plants, Medium voltage

# TABLE OF CONTENTS

<b>LIST OF TABLES</b> .....	vi
<b>LIST OF FIGURES</b> .....	vii
<b>LIST OF ABBREVIATIONS</b> .....	viii
<b>1 INTRODUCTION</b> .....	1
1.1 Background .....	1
1.2 Literature Review .....	4
1.3 Problem Statement/ Justification.....	7
1.4 Objective of the Study.....	7
1.5 Research Methodology.....	8
<b>2 PRESENT REACTIVE POWER GENERATION AND CAPABILITY STUDY</b> .....	9
2.1 Reactive Power Generation from Main Power Plants.....	9
2.2 Medium Voltage Grid Capacitor Banks.....	10
2.3 Capacitor Banks at Medium Voltage Lines .....	11
2.4 Distributed Generators at distribution network.....	11
2.4.1 Diesel Generators.....	12
2.4.2 Wind Power Plants.....	12
2.4.3 Bio Mass Plants.....	12
2.4.4 Mini Hydro Plants.....	12
2.5 Capability of Mini Hydro Plants for reactive power generation.....	13
<b>3 OPTIMIZATION OF LOSSES THROUGH DISTRIBUTED REACTIVE POWER GENERATION</b> .....	15
3.1 Simulation of MV feeder with SynerGee Software .....	15
3.1.1 Actual Feeder simulation with SynerGee (Ukuwela Grid Feeder-10, CEB).....	17
3.1.2 Use of Genetic Algorithm.....	20

3.2	Simulation with Matlab Software .....	22
<b>4</b>	<b>CASE STUDY WITH UKUWELA FEEDER-10 .....</b>	<b>28</b>
4.1	Introduction .....	28
4.2	Demand Curves for Ukuwela Feeder-10.....	30
<b>5</b>	<b>FINANCIAL ANALYSIS.....</b>	<b>34</b>
5.1	Cost of an energy unit for Ukuwela Feeder-10.....	34
5.2	Calculation of saving in a day at Ukuwela Feeder-10 .....	35
5.3	Calculation of annual energy and financial saving in Ukuwela Feeder-10...35	
<b>6</b>	<b>CONCLUSION .....</b>	<b>37</b>
6.1	Recommendations .....	38
6.2	Suggestions for future work .....	38
	<b>Reference List.....</b>	<b>39</b>

## LIST OF TABLES

Table 2.1: Major Reactive Power Generation Plants in Sri Lankan Network .....	9
Table 2.2: Grid Capacitor banks in Sri Lankan network .....	10
Table 3.1: Loss and Voltage Variation with Power Factor Variation of MHPs .....	19
Table 3.2: System Loss with Variation of Power Factor in MHPs by 0.01 Intervals..	25
Table 4.1: Hourly Power Factor Schedule for MHPs in Ukuwela Feeder 10.....	32
Table 5.1: Average Transfer Price from Transmission to Distribution Licensees Tariffs for Jan-June 2014.....	34
Table 5.2: Hourly Energy Saving in a Day at Ukuwela Feeder 10.....	35
Table 5.3: Annual Energy Saving.....	36
Table 5.4: Annual Financial Saving.....	36



## LIST OF FIGURES

Figure 1.1: Daily Generation profile of a MHP .....	4
Figure 2.1 : Line Capacitor Banks at Horana New Gantry (450 kvar) and Malambe Gantry (300 kvar) in Sri Lankan Distribution Network .....	11
Figure 2.2: A Synchronous Generator Capacity Curve .....	14
Figure 3.1: Model Feeder with single MHP .....	16
Figure 3.2: Loss Variation of Model Feeder with Power Factor Variation of MHP in Peak and off Peak.....	16
Figure 3.3: Ukuwela Feeder 10 with Three MHPs .....	18
Figure 3.4: Loss and Maximum Voltage Variation along Feeder at Off Peak .....	19
Figure 3.5: Loss and Minimum Voltage Variation along Feeder at Peak .....	20
Figure 3.6: Flow Chart of Simulation Method with SynerGee Software .....	21
Figure 3.7: Model Feeder with Two MHPs.....	22
Figure 3.8: Model Feeder with Single MHP in MATLAB Simulink .....	23
Figure 3.9: Results of Model Feeder with Single MHP .....	24
Figure 3.10: Model Feeder with Two MHP in Matlab .....	24
Figure 3.11: Graphical Representation of 400 Nos Simulations .....	25
Figure 3.12: Flow Chart of Simulation Method with Matlab .....	26
Figure 3.13: Results of Model Feeder with Two MHPs with Genetic Algorithm for Peak Load .....	26
Figure 3.14: Results of Model Feeder with Two MHPs with Genetic Algorithm for Off Peak Load.....	27
Figure 4.1: Reactive Power Flow with 33kV Capacitor Bank at Grid Substation .....	28
Figure 4.2: Ukuwela F10 and Two Transmission Line model in Matlab.....	29
Figure 4.3: Peak Simulation Result for Minimum Losses .....	30
Figure 4.4: Off Peak Simulation Result for Minimum Losses .....	30
Figure 4.5: Active Power Demand Curves for Ukuwela Feeder-10.....	31
Figure 4.6: Reactive Power Demand Curves for Ukuwela Feeder-10.....	31
Figure 4.7: Hourly Loss Variation in Current System and Propose System in Ukuwela Grid Feeder 10 .....	33

## LIST OF ABBREVIATIONS

ACSR	Aluminum Conductor Steel Reinforced
AR	Auto Recloser
BSC	Breaker Switched Capacitor
CEB	Ceylon Electricity Board
CRO	Control Room Operator
DNO	Distribution Network Operator
DCC	Distribution Control Centers
DG	Distributed Generators
GSS	Grid Substation
GA	Genetic Algorithm
HV	High Voltage
kVA	kilovolt Ampere
kW	kilo Watt
kWh	kilo Watt hour
MV	Medium Voltage
MVA	Megavolt Ampere
MW	Mega Watt
MWh	Mega Watt hour
MHP	Mini Hydro Plant
OPF	Optimum Power Flow
OLTC	On Load Tap Changer
PUCSL	Public Utilities Company Sri Lanka
PSS	Primary Substation
SPP	Small Power Producer
SVC	Static Var Controller
SCADA	Supervisory Control and Data Acquisition

## INTRODUCTION

### 1.1 Background

Different forms of energy sources are used in the world. Electrical energy is the most flexible and preferable form of energy. Electricity power utilities play a major role in enhancing the quality of life of people. Around 17% of global energy demand is supplied by electrical energy [1]. With the increase of living standard, the per head energy consumption also increases. Therefore, the global electricity demand is increasing by day. On the other hand, the amount of energy losses are also considerably increasing. It can be reduced by increasing efficiency of apparatus, reducing losses in power system and increasing efficiency during power generation. Generally, there is 10% to 20% energy loss in a power system. Therefore, increasing efficiency of power system has the highest importance. Both, Active and reactive power flows cause energy losses in power systems. Most of the electrical equipment's consume active power as well as certain amount of reactive power (VAR loads). Magnetic fields of motors/transformers are maintained by reactive current. Reactors, florescent lamps, and all inductive circuits require certain amount of reactive power. The series inductance of transmission lines also consumes reactive power.

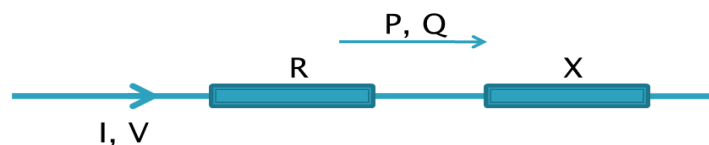

$$P^2 = S^2 - Q^2$$

$$I^2 = \frac{P^2 + Q^2}{V^2}$$

$$P_L = \left( \frac{P^2 + Q^2}{V^2} \right) R$$

Compensation devices, which are used for offsetting reactive loads should be capable of generating reactive power. Reactive power requirement is provided in various ways such as, supplied by power generating plants, compensation by means of capacitor bank

at the utility grid and compensation at the load point through capacitors. In the national grid of Sri Lanka, the demand for reactive power varies throughout the day and it reaches its maximum in the day peak and it reaches its minimum in the off peak. In Sri Lankan power system, most of the reactive power demand is supplied from major generation stations via longer transmission and distribution lines. In power systems, the following devices are used to supply reactive power.

- ❖ Synchronous condensers
- ❖ Conventional generators
- ❖ Capacitors
- ❖ Static VAR compensators

Earlier, conventional synchronous generators and synchronous condensers were the most popular methods used to supply reactive power Demand. Mostly, these methods are used in generation and transmission stages. This leads to increase the current flow in transmission and distribution network which in turn increases real power loss in the power system. Hence, in order to reduce the losses and to increase the network capacity, it is always advisable to compensate reactive power locally at the distribution end. This can be achieved by installing the reactive power compensation devices which are either distribution capacitors, Grid capacitor or distributed generators like mini hydropower plants at the medium voltage distribution network, which produces reactive power closer to the load centers.

Producing reactive power requirement at customer end can be done in a smaller scale. But in order to produce it in bulk scale and closer to the customer end can be done at Medium voltage level. Among above devices, power capacitors are the most commonly used device in a power system, since they are comparatively economical and easy to install. Since, the reactive power occupies a proportion of available transmission capacity and increases the system losses, it is important to make the distance between the compensating device and the apparatus to be compensated as short as possible. Shunt capacitor banks also help to reduce the losses in the transmission network and improve the system performance.

For customers at the distribution end, shunt capacitors can be used as power factor correction devices to reduce demand and to avoid penalties from the utility. For

distribution network and transmission network, shunt capacitors are used to reduce line losses and hence increase the line capacities and improve the bus voltage. If shunt capacitor banks are not properly selected and placed in a power system, they could amplify and propagate harmonics, deteriorate power quality to an unacceptable level and produce transients that will negatively affect the switchgear in a Grid Substation (GSS).

Medium voltage system consists of many distributed generators, mostly with mini hydro power plants. The total installed capacity of Mini Hydropower Plants (MHP) connected to CEB medium voltage distribution network is around 180MW. Most of them are located at the end of feeders in remote areas and operated solely in the purpose of providing real power to the system.

Since, almost all the generators of these MHPs are of synchronous type, they can be utilized to compensate reactive power demand in a power system while meeting their primary objective of generating real power. Due to inconsistency of inflow, these MHPs do not run at full load continuously throughout. Therefore, during low inflow condition, they would generate excess amount of reactive power that can be utilized to compensate reactive power demand in the power system. This would avoid spending huge amounts of capital investment for installing reactive power compensation devices such as capacitor banks.

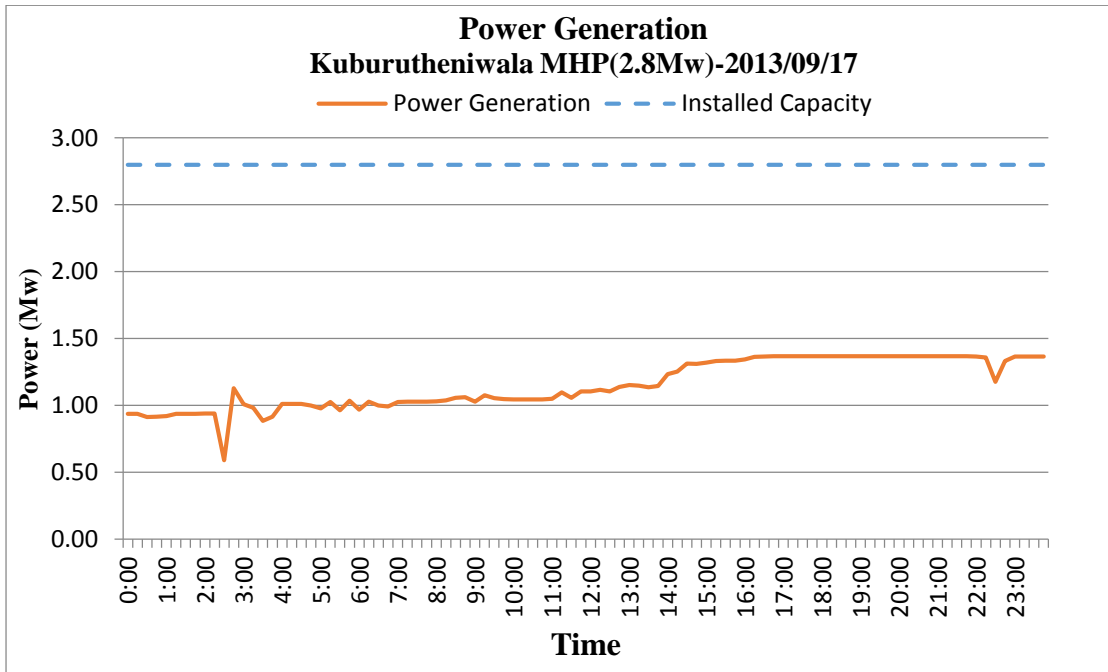

**Figure 1.1: Daily Generation profile of a MHP**

This research is focused on developing an optimized reactive power dispatch schedule through MHPs to cater the reactive power demand of the power system to minimize network losses.

## 1.2 Literature Review

The literature survey was aimed at finding ways of optimizing reactive power injection to the power system. The location and timing in which reactive power should be injected, the quantity of reactive power that needs to be injected and the effectiveness of distributed reactive power generation are the most important factors studied during the literature review.

The work by Dr. Akram F. Bati, Dr. Nowfal M. Taher and Mr. Omar H. Mohammed [6] discusses how shunt capacitors are placed in a power distribution systems using the Genetic algorithm. This method is used to place capacitor for correcting voltage deviation, power factor and reducing real power losses in a power system. Load flow solution, sensitivity analysis and genetic algorithm are three major tools discussed in this paper.

In this research, two methods with different accuracies were carried out for load flow solutions. These are simplified methods using approximation of P & Q and fast decouple technique. This paper considers cost of installation of capacitor banks and considers life time of a capacitor bank as 10 years for cost optimization with reactive power compensator placement or generation. Whereas our research does not incur any cost of investment. Sensitivity analysis is to find best location for placement of capacitor banks. In our case is not required to find the locations of MHPs since they are already placed and connected to the grid. By using genetic algorithm, optimum size, number and type are determined. A chromosome represents size and number of capacitors. Fitness/objective function combines the energy losses and the cost associated with the capacitor placement. However with the MHPs, amount of the reactive power supply to the system is limited by the active power production at the time, with power factor.

The work by Dinakara Prasad Readdy, C. Hari Prasad, M.C. V. Suresh [5] presents how to place capacitor banks using Bat Algorithm with maximum annual saving in a radial distribution system. This paper discusses optimal placement and sizing of capacitor banks on a radial distribution system to improve voltage profile and to how to reduce the active power losses. They have also used loss sensitivity method to find best capacitor locations and have obtained capacitor sizes by iterative process of Bat algorithm. Fitness/objective function provides the maximum annual saving by considering peak power losses, energy losses and cost of capacitor installation. However in our research,  $Q_{max}$  and  $Q_{min}$  are dependent on the running active power at the time and minimum lagging power factor capability of the generator.

The work by Mr. Siddharth Deshmukh, Mr. Balasubramaniam Natarajan and Mr. Anil Pahwa [14] discusses how reactive power injection from distributed generators can be used to mitigate the voltage/VAR control problem of a distribution network. Sequential convex programming is proposed for finding solutions. Formulate equations determine the optimal reactive power injection while maintaining voltage within safety limits, satisfying power flow equations, individual DGs minimum and maximum reactive power capabilities and phase imbalances. For this analysis, it is assumed that all reactive and active loads of the system are known and constant and there are no limitations supplying any required amount of reactive power from grid. Discussion includes pros

and cons of stochastic search methods when finding optimal solutions. Another method used for finding optimal solution is called branch and bound method and it is compared with the sequential convex programming method. Finally proposed method was applied to the 10 node and 123 IEEE node system to validate the proposed method. However this paper discusses only about reactive power optimization with regard to the voltage/VAR control on the distribution system and loss optimization is not included in the research.

The work by S. Kumara Injeti and Dr. Navuri P Kumara presents optimal planning of Distributed Generation for improved Voltage stability and loss reduction in a distribution power system [12]. Connecting distributed generators to a distribution power system leads the system to become an active power system, which results in an improvement of voltage profile and reduction of power losses. In this paper, a new analytical expression is used to calculate optimal sizing of DGs and fuzzy logic is used to identify the optimal location of DG. It shows that poor selection of location and sizing of DGs in a distribution power system would lead to higher losses than the losses without DGs. At the same time the proposed method is suitable for selection of a single DG in a given distribution network. However, this paper does not consider other benefit of DGs. Reactive power injection and quantification for optimization of power losses for a distribution power system were not considered in this paper.

The work by Luis F. Ochoa and Gareth P. Harrison discusses minimizing Energy Losses, Optimal Accommodation and Smart Operation of renewable Distributed Generation [7]. In this paper a simple test feeder is used to contrast the power and energy loss minimization approaches, the loss minimizing multi period OPF and its embedded smart grid based schemes and cause study with generic UK distribution network using real demand and wind speed data. This research mainly focuses on how maximum wind or DGs penetration to distribution network can be achieved by voltage controlling at the substation tap changer (OLTS) and varying power factors at DGs. More weight is put on to identify how to increase wind capacity by applying above techniques to increase renewable energy penetration and losses reduction. No study has been done on how power factor of DGs should vary according to the demand variations. Only one demand condition (Peak) and one lagging and leading power factor have been considered.



### **1.3 Problem Statement/ Justification**

At present most of active and reactive power requirement of system loads are generated in the power plants and transmit through utility transmission and distribution network. This leads to higher transmission and distribution losses and is an ineffective way of utilizing transmission and distribution facilities in the network. Further a small scale reactive power generation at grid substation is little ahead than traditional way but it also added ineffectiveness to the distribution level network.

In order to reduce active power losses and increase network capacity, the reactive power requirement should be provided or compensated at the distribution level more closely to load centers by means of reactive power generating sources. Since the embedded generators are connected to distribution network and most of them are synchronous generators, there is a possibility to utilize these generators for supplying reactive power requirement without much affecting their active power generation to the grid. This could save the capital investment of additional reactive power generating sources such as medium voltage level capacitor bank and be a better way of utilizing existing resources in an optimal way.

### **1.4 Objective of the Study**

The objective of this research is to identify present system losses and minimize the losses in the power system through optimizing reactive power generation by distributed generators in medium voltage lines.

Following are the outcomes of the research,

- ❖ Develop a schedule to dispatch reactive power from synchronous based embedded generators to minimize system losses.
- ❖ To evaluate financial benefit from the above scheme

## **1.5 Research Methodology**

- ❖ Collection of data from distributed generators and load profile of selected grids in Sabaragamuwa and Central province
- ❖ Model existing distribution network with embedded generators
- ❖ Analyze present reactive power requirement and losses in the network
- ❖ Develop a reactive power dispatch scheme to provide reactive power requirement of loads by using embedded generators
- ❖ Software simulation of Reactive power flows
- ❖ Estimation of loss reduction
- ❖ Evaluation of economic benefits of the above scheme.

## **PRESENT REACTIVE POWER GENERATION AND CAPABILITY STUDY**

### **2.1 Reactive Power Generation from Main Power Plants**

In good old days and in traditional electricity networks, reactive power was generated from the major power plants and transmitted through HV transmission network, then through distribution network to loads. Table 1.1 shows major power plants in Sri Lanka which generates reactive power. Since, most of these power plants are situated in remote areas, the losses in the system become high due to longer distance between the plants to the loads.

**Table 2.1: Major Reactive Power Generation Plants in Sri Lankan Network**

(As at March 2016)

<b>NO</b>	<b>Plants</b>	<b>MW</b>	<b>Mvar</b>
01	Norochcholai	900	540
02	West Coast	300	170
03	Kelanitissa Combine Cycle	163	140
04	Kothmale	130	120
05	Upper Kothmale	150	100
06	Ambilipitiya (Now retired)	100	40
07	GT7	115	40
08	Heladanavi (Now retired)	100	40

In some countries, electricity market is fully unbundled and liberalized. Their regulators provide economic incentives to those distribution network operators (DNO) to perform targets set for a given period such as allowed loss percentage, renewable energy penetration etc. Different targets are set for each DNO according to the specific geographical situations, special circumstances etc. If targets are not met by the DNOs they will have to undergo economic penalties. Therefore, in a regularized electricity market DNOs are more towards high performance network and its main target is to

minimize losses in distribution network. Therefore, DNOs implements whatever possible methods to reduce losses in the distribution network.

## 2.2 Medium Voltage Grid Capacitor Banks

Sources of reactive power generation should be shifted close to the load in order to reduce the losses. This can be achieved by installing capacitor banks at grid substation itself. Breaker switched capacitor (BSC) banks are mostly installed at grid substation in order to cater the reactive power requirement in Sri Lankan power system. The existing BSC banks installed at grid substations and their capacities are shown in the table 2.2. All the banks are connected as ungrounded double star configuration and all the capacitor banks in CEB network are connected to the 33kV load bus in the relevant grid substation. There are no capacitor banks at the transmission level since, connecting BSC banks at Medium voltage level is more cost effective than connecting them at higher voltage levels.

**Table 2.2: Grid Capacitor banks in Sri Lankan network**

(As at March 2016)

No	Location	Capacity (Mvar)
1	Galle	20
2	Habarana	10
3	Kotugoda	50
4	Kiribathkumbura	20
5	Kurunagala	10
6	Matugama	20
7	Panadura	20
8	Puttalama	20
9	Athurugiriya	20
10	Thulhiriya	10
11	Ampara	30
12	Pallekele	20
<b>Total</b>		<b>250</b>

### 2.3 Capacitor Banks at Medium Voltage Lines

By installing Line Capacitor banks at distribution network, line losses will be reduced by shifting the reactive power source towards the load centers. There are two types of line capacitors available, namely Switched line capacitor banks and Fixed line capacitor banks. Switched line capacitor banks are switched to on and off state according to reactive power requirement while fixed line capacitor banks supply constant reactive power irrespective of the existing reactive power demand in the network. Figure 2.1 shows how line capacitor banks are installed on the concrete pole. In case of a failure in grid capacitor banks, Control Room Operator (CRO) or technician can clear the fault or can bypass the fault. Whereas, line capacitor banks, which are located in remote places, will need extra time to clear the fault. Different methods are applied for selecting locations and sizing of line capacitor banks [5, 6]. Installing capacitor banks at grid or line incur extra investment. For example, to install a 5Mvar Capacitor bank at GSS, it will cost around 15 Million of Sri Lankan Rupees.

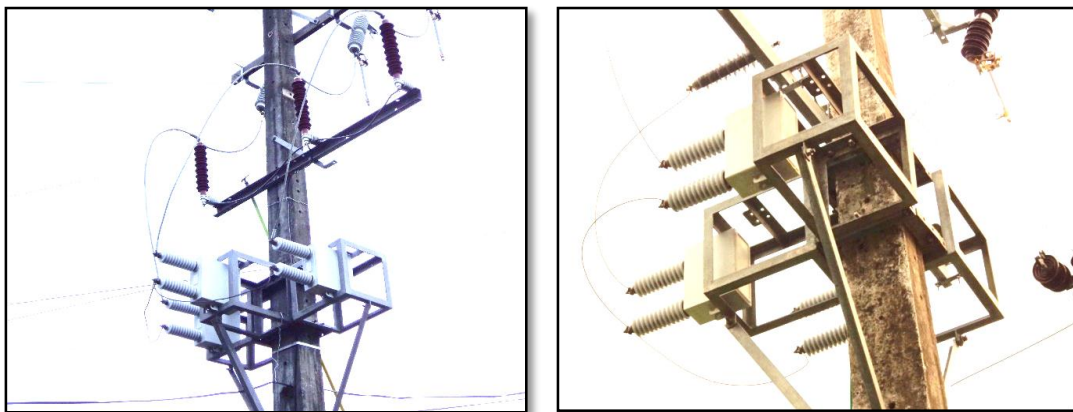

**Figure 2.1 : Line Capacitor Banks at Horana New Gantry (450 kvar) and Malambe Gantry (300 kvar) in Sri Lankan Distribution Network**

### 2.4 Distributed Generators at distribution network

The impact of DG units on energy losses will depend on specific characteristics of the medium voltage network. Such as demand distribution along the line, behavior of the load, topology of the network, location of the generators on the feeder and whether their output is firm or variable. Incorporating these complexities is a challenge that has only been partially address by a few studies. Several types of distributed generators are been

used at the distribution networks level in Sri Lanka. Namely, Diesel Generators, Wind Power Plants, Bio Mass Plants and Mini Hydro Plants.

#### **2.4.1 Diesel Generators**

Diesel generators use diesel IC engines as prime moves to rotate the alternator. This engines are high speed engines. In Sri Lanka, few Diesel Generators are connected to medium voltage level. For example, Uthuru Janani, Northern Power (Not in Use), Heladanavi(retired), ACE Mthara(retired) and ACE Horana(retired) etc.. Lot of bulk consumers who connect with medium voltage system are having diesel generators in small capacities. But those are running at isolated state rather synchronizing with main power system.

#### **2.4.2 Wind Power Plants**

Wind energy is a source of renewable power which comes from air current flowing across the earth's surface. Wind turbines harvest this kinetic energy and convert it into usable electricity power. The intermittency of wind does not create problems when using wind power at low to moderate penetration levels. Many countries have considerable wind resources, which are still untapped.

#### **2.4.3 Bio Mass Plants**

Bio mass power plants produce electricity by burning bio mass in a boiler. Biomass can be made up of scrap lumber, forest debris, certain crops, manure and some types of waste residues. With a constant supply of waste from construction and demolition activities, from wood not used in papermaking and from municipal solid waste, green energy production can continue indefinitely. Biomass is a renewable source of fuel to produce energy since waste residues will always exist in terms of domestic waste, industrial waste, scrap wood, mill residuals and the residual biological matter from those sources are available in excess than their consumption.

#### **2.4.4 Mini Hydro Plants**

Mini hydro generation is a form of clean electricity generation, and it is one of the most cost-effective and reliable energy technologies in distributed generation systems. These systems can be a viable alternative to address generation and electric power supply

problems to isolated regions or small loads. For example in “Memure” area in central province, which had not been connected to the national grid, had been powered by two MHPs. The key advantages that small hydro has over other technologies when compared with other distributed generation systems, such as, wind, wave and solar power are,

- ❖ The highest efficient technology with 70 – 90% efficiency among all other energy technologies.
- ❖ A high level of predictability, varying with annual rainfall patterns.
- ❖ A high plant factor (typically >50%), compared with 10% for solar and 30% for wind.
- ❖ It is a more durable and robust technology systems can readily be engineered to last for 30 years or more.
- ❖ Non stochastic behavior of the output power (Slow rate of change the output power varies only gradually from day to day not from minute to minute).

It is also an environmentally friendly technology. Small hydro in most cases are “run-of-river” type. Any dam or barrage is quite small, usually just a weir, and little or no water is stored. Therefore, unlike large-scale hydro plants, run-of-river installations do not have the same kind of adverse effects on the local environment. In Sri Lanka, power plants with installed capacities less than 10 MW are consider as MHP.

Out of above methods Mini Hydro Power Plants are the most popular and implemented method in Sri Lanka.

## **2.5 Capability of Mini Hydro Plants for reactive power generation**

Most of the generators in MHPs are synchronous generators. These type of generators can supply reactive power, by over excitation of field winding. The continuous reactive power generation capability is dependent on armature current limit, field current limit and end region heating limit [2] as shown in figure 2.2.

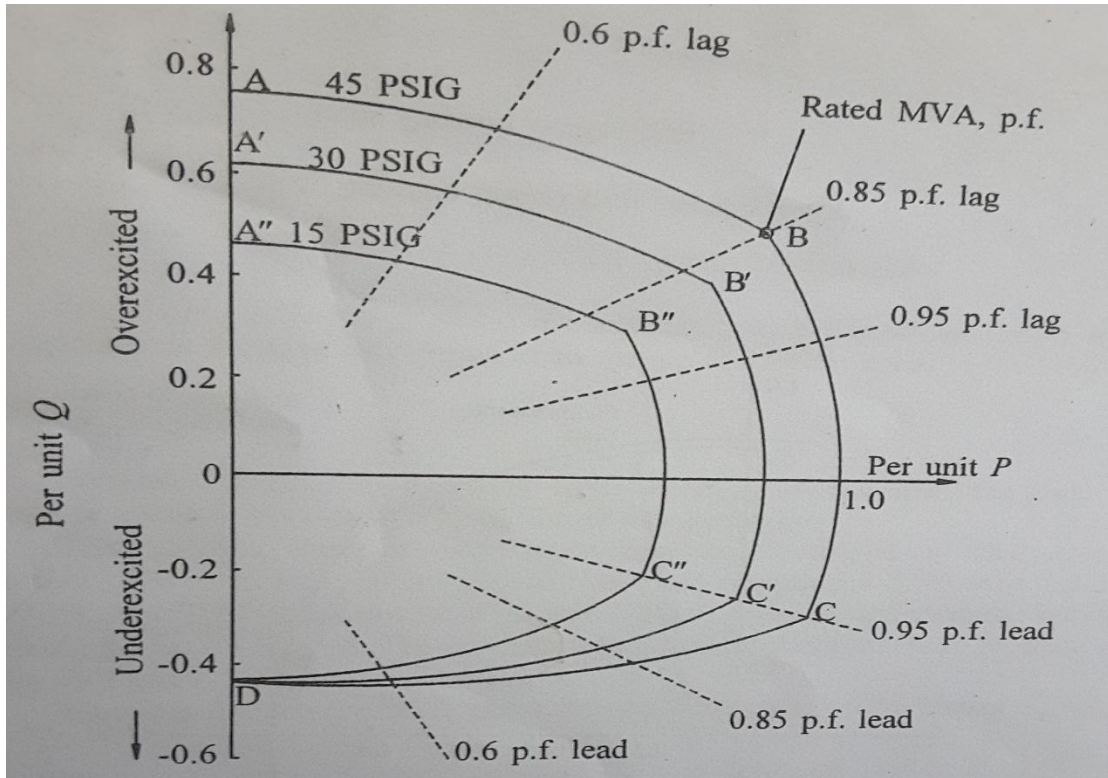

**Figure 2.2: A Synchronous Generator Capacity Curve**

Source: (Prabha Kundur, "Power System Stability and Control", Chapter 5,)

Lagging power factor can supply reactive power to the power system by overexciting the synchronous generator. Armature current and field current result in  $I^2R$  energy losses in windings, which in turn heats the winding as well as surrounding environments. Therefore, generation of reactive power is limited by armature and field winding heating limits.

According to the CEB guide line for MHP, all generators must be capable of operating their power factors between the limits of 0.85 lagging to 0.95 leading at the terminals of generator [3]. Therefore, all MHPs connected to the national grid in Sri Lanka are capable of supplying reactive power to the system by running at 0.85 power factor or more.



### **OPTIMIZATION OF LOSSES THROUGH DISTRIBUTED REACTIVE POWER GENERATION**

In this chapter an MV feeder is modeled using SynerGee and Matlab software. The MV feeder is modeled and analyzed considering several instances, where model feeder with single MHP and model feeder with two MHPs etc. Losses in the feeder is analyzed for the peak and off peak separately.

#### **3.1 Simulation of MV feeder with SynerGee Software**

SynerGee software is widely used in analyzing, planning and simulating the MV system. In CEB, most of the distribution planning is being carried out by using this software. Therefore, the model of MV power system of CEB, is available with this software for simulation purposes. Hence, this MV model can easily be used for simulation of this proposed method by using SynerGEE software. SynerGEE version 3.50 was used for this research simulation work. In the software, power factor of MHPs can be adjusted manually, but proposed optimization scenario cannot be simulated with the software. Therefore, with this software the proposed method cannot be implemented though automated simulation, but it can be done manually by feeding data to the system. The variation of losses along the feeder was studied with reference to the variation of power factor through this software. A model of hypothetical feeder was designed on the software for this purpose. The model feeder consist of distributed loads totaling 10 kVA and 0.88 lag power factor. Total length of the model feeder is 20 km. A MHP of 4MW was added to this model at 15km from the grid substation.

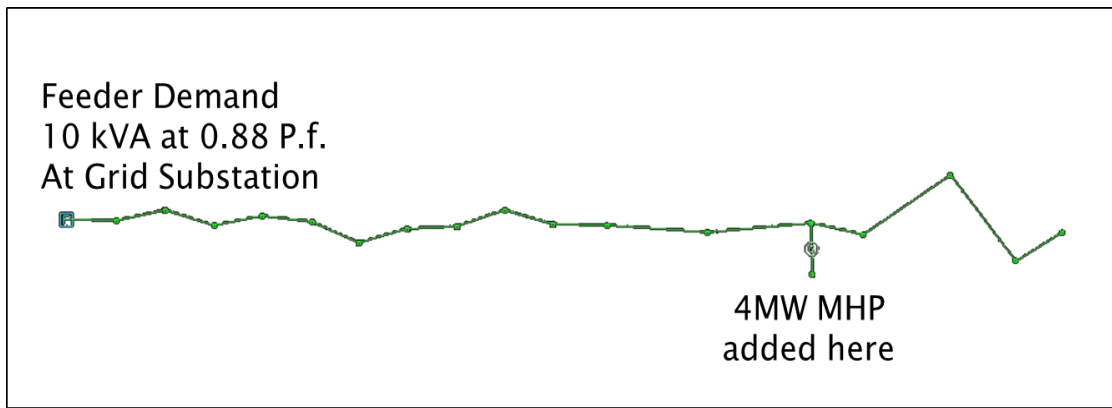

**Figure 3.1: Model Feeder with single MHP**

Simulations were done with model feeder in synerGee software by varying power factor by 0.05 intervals in MHP to study the variation of losses along the feeder. Loss variation with respect to peak and off peak demand were obtained for this model feeder to study how to optimize loss reduction with varying load along the feeder. Results were obtained from the simulation as per the figure 3.2.

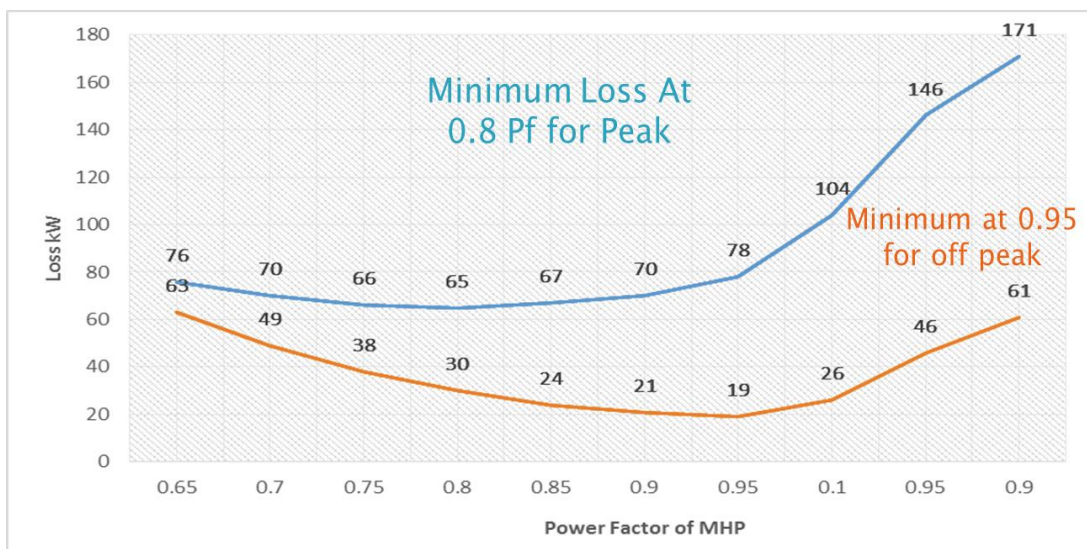

**Figure 3.2: Loss Variation of Model Feeder with Power Factor Variation of MHP in Peak and off Peak**

Since, single MHP was used for this study, it was very easy to find power factor of MHP in which it gives the minimum losses in the model feeder. A MHP with leading power factor consumes reactive power which in turn increases the losses in the system. Most of the time MHPs run at unity power factor or leading power factors. But results

show that, at peak load MHP should run at 0.8 power factor and at off peak at 0.95 power factor to operate under minimum loss condition. Hence, the power factor which results minimum loss, varies with the load condition of the feeder [Figure 2.2]. Therefore, power factor of MHP should be changed in such way that it gives minimum losses with respect to the demand.

### **3.1.1 Actual Feeder simulation with SynerGee (Ukuwela Grid Feeder-10, CEB)**

Ukuwela Grid is situated in Matale district in central province and it is connected with several MHPs totaling more than 25MW. These MHPs are connected to HV transmission network via two units of 30.5MVA 132/33kV transformers at the Ukuwela grid substation. There are prospective MHPs to be constructed in the near future that will connect to this grid substation. Feeder 10 is selected to study above scenario. Ukuwela feeder 10 is connected with three MHPs, namely Werapitiya, Giddawa and Falkan. Installed capacities of the three MHPs are 1MW, 2MW and 2.4MW respectively. Geographical and major configurations are as per figure 3.3. Feeder demand and power factors at the peak time are around 20kVA and 0.87. This feeder consists of two major gantries and one 33/11kV Primary Sub Station (PSS) to feed underground system. Lynx (226.2mm<sup>2</sup>) ACSR conductor is used in first part of backbone line up to Karalliyadda gantry and rest of the lines are Racoon (80mm<sup>2</sup>) ACSR conductors.

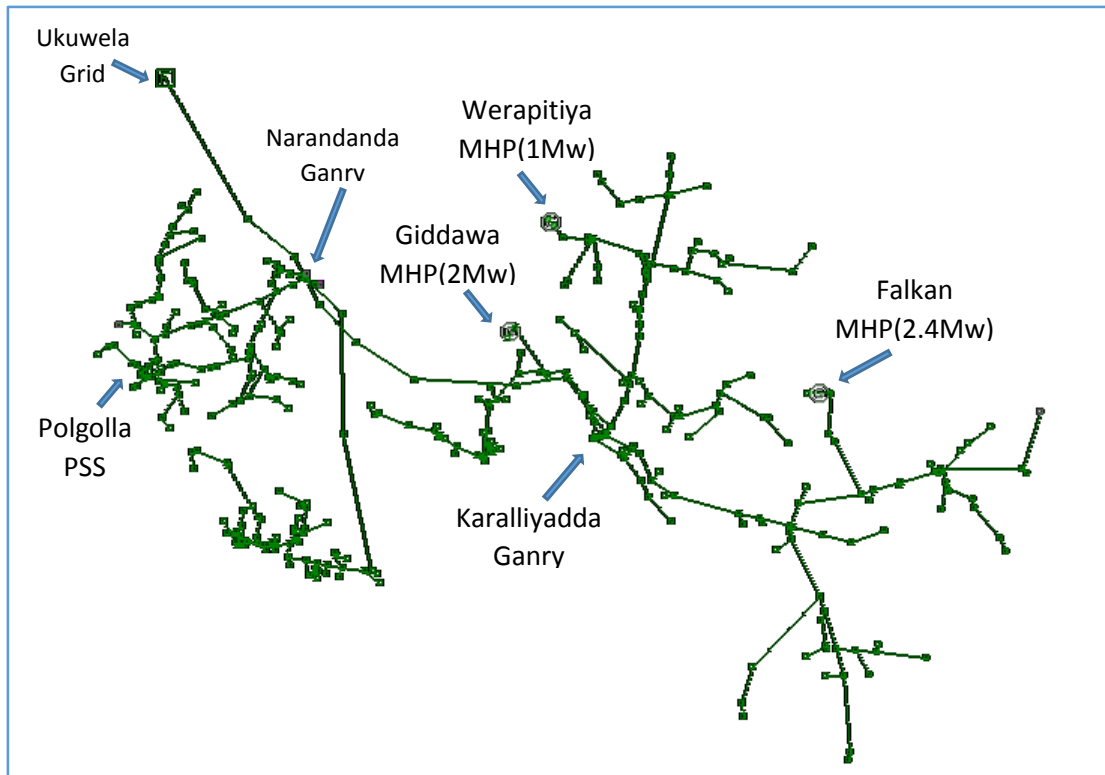

**Figure 3.3: Ukuwela Feeder 10 with Three MHPs**

Simulations were done at peak and off peak demand conditions. Off peak demand is nearly 25% of the peak demand. Due to inconsistency of water inflow the MHPs, they do not run at full load in most of the time. Therefore, 70% of full load capacity of MHP is considered as its running condition. Power factors of three MHPs are to be varied to study variation of losses in the Feeder. Since there are three MHPs, large amount of combinations of power factors are to be considered and will be entered to SynerGEE software for simulation to find the power factor combination which gives the minimum feeder losses. Therefore, randomly selected few configuration were consider for simulation.

At peak loads, due to heavy demand, voltage profile at the feeder drops considerably. On the other hand at light demand, voltage profile along the feeder is increased. Therefore, in above simulations the voltage variation was also studied. Maximum voltage of the feeder at off peak demand and minimum voltages of the feeder at peak load with respect to each combination of power factors were considered for this loss

minimization simulation. Eleven power factor combinations were considered for this simulation and result were tabulated as in table 3.1.

**Table 3.1: Loss and Voltage Variation with Power Factor Variation of MHPs**

Capacity	MHP	Power Factor Combinations											
		1	2	3	4	5	6	7	8	9	10	11	
2.4MW	Falcán	1	0.9	0.9	0.9	0.9	0.9	0.9	0.9	0.9	0.9	0.8	0.7
1MW	Werapitiya	1	1	0.9	0.9	0.9	0.9	0.9	0.9	0.8	0.7	0.9	0.9
2MW	Giddawa	1	1	1	0.9	0.8	0.7	0.6	0.8	0.8	0.8	0.8	0.8
Off Peak	Loss (kW)	177	171	169	169	179	189	192	174	176	180	190	
	Loss %	4.2	4.1	4	4	4.2	4.2	4.4	4.1	4.1	4.2	4.4	
	Maximum Voltage (P.U)	99.4	100	101	101	102	102	102	102	102	102	102	
Peak	Loss (kW)	575	550	541	519	512	508	509	510	508	509	511	
	Loss %	4.3	4.1	4	3.8	3.8	3.7	3.7	3.8	3.7	3.7	3.7	
	Minimum Voltage (P.U)	93.2	93.4	93.5	93.7	93.8	93.8	94.1	93.9	93.9	93.9	94	

Results of table 3.1 for off peak demand is graphically represented in figure 3.3. Multiple minimum loss configuration were identified from the simulation.

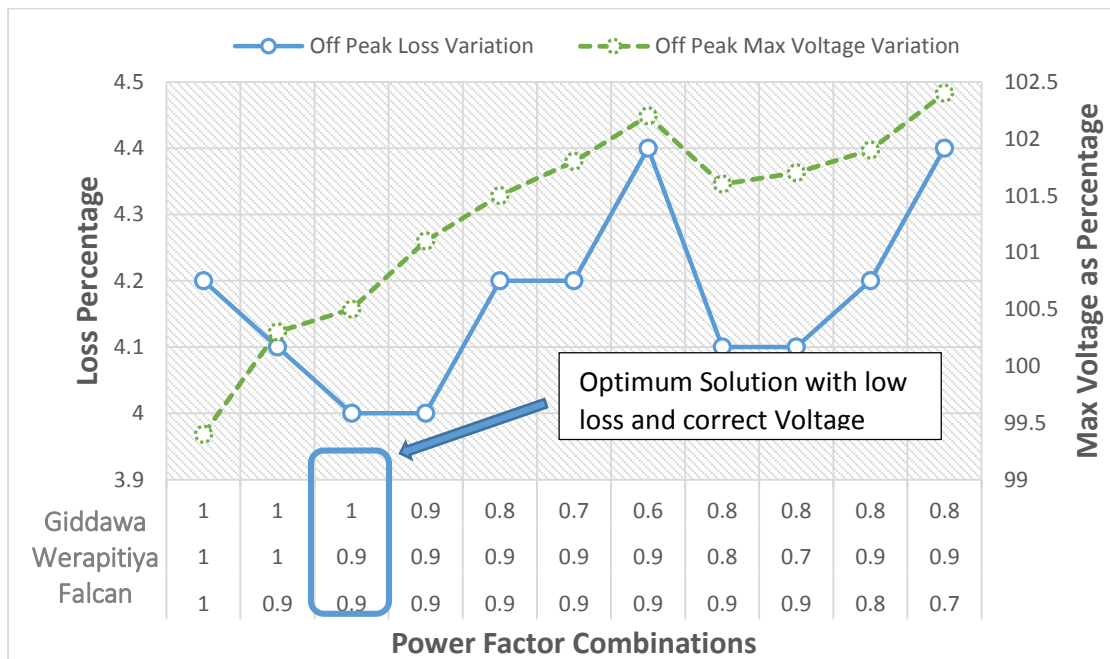

**Figure 3.4: Loss and Maximum Voltage Variation along Feeder at Off Peak**

Viability of suitable power factors of MHPs and maximum and minimum voltage along the feeder at off peak and peak were considered for selecting best power factor combination (that produces minimum losses).

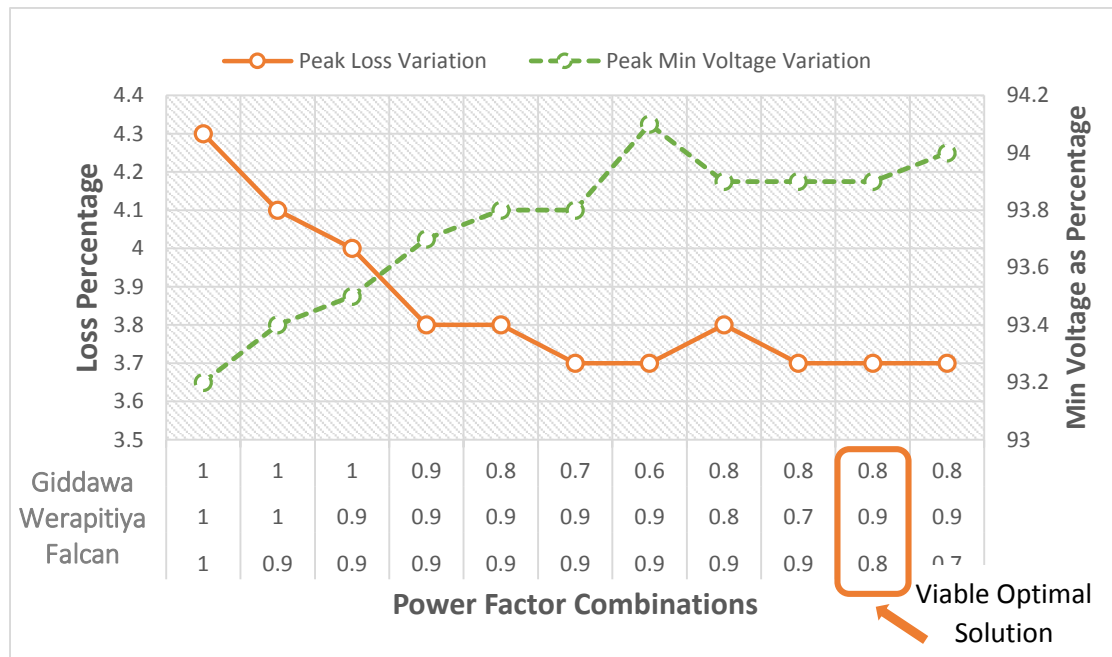

**Figure 3.5: Loss and Minimum Voltage Variation along Feeder at Peak**

Power Factor combinations of MHPs were selected by 0.1 intervals to reduce number of combinations for simulation. But random selection of power factors for simulation did not give accurate figures for the output result. On the other hand, this method does not use all combinations for simulation. Therefore, it does not guarantee whether results of the method give the optimum solution. Hence, optimization techniques such as Genetic algorithm was proposed for finding optimum solution.

### 3.1.2 Use of Genetic Algorithm

Genetic Algorithm [6] was selected as an optimization technique to find minimum loss configuration at the feeder while varying power factor of MHPs. Genetic Algorithms (GA) is adaptive heuristic search algorithm based on the evolutionary ideas of natural selection and genetics and used for solving both constrained and unconstrained optimization problems. As such they represent an intelligent exploitation of a random search used to solve optimization problems. Although randomized, GA is by no means random, instead they exploit historical information to direct the search into the

optimization region. Random power factor were selected at the starting of algorithm and created sample pool. System losses were considered as fitness value for genetic algorithm technique calculation. A simple GA consists of five basic operators, which are representation or coding, evaluation string, reproduction or selection, crossover and mutation. The algorithm repeatedly modifies a populations which are power factor of MHPs in individual iteration. Proposed method is illustrated in figure 3.6 as a flow chart.

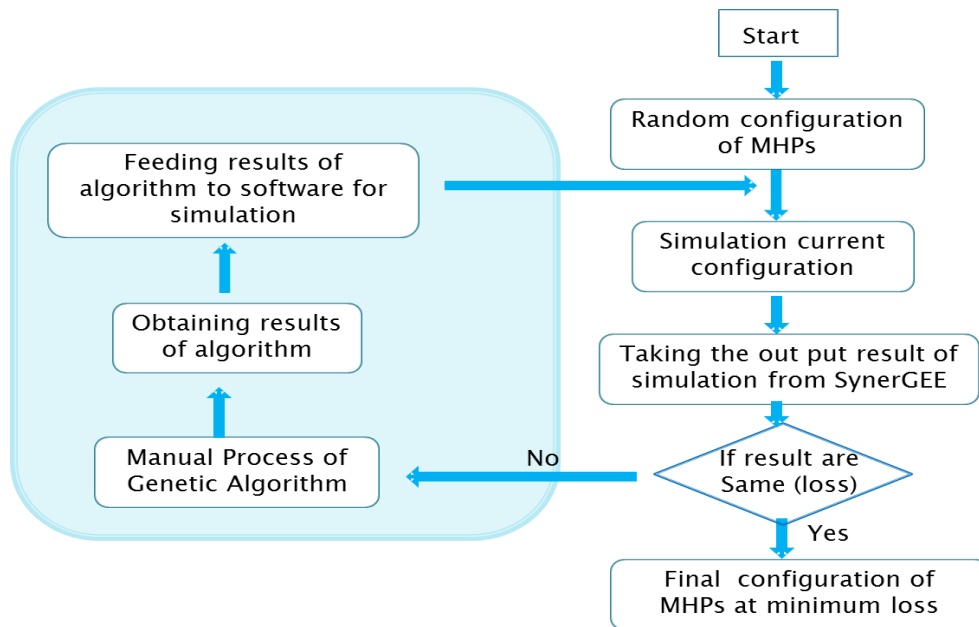

**Figure 3.6: Flow Chart of Simulation Method with SynerGee Software**

In this method, genetic algorithm calculates manually and feed results to software at each simulation. With several iteration fitness values give same results as previous simulation. Then, last power factors combination relevant to the minimum fitness value, were selected as final configuration. To study validity of this method a model feeder with two MHPs were implemented as shown on figure 3.7. Distributed loads totaling 10 kVA at power factor of 0.88 lagging were added to the 20 km model feeder, while adding 4MW MHP at 15km and 2MW at 10km respectively.

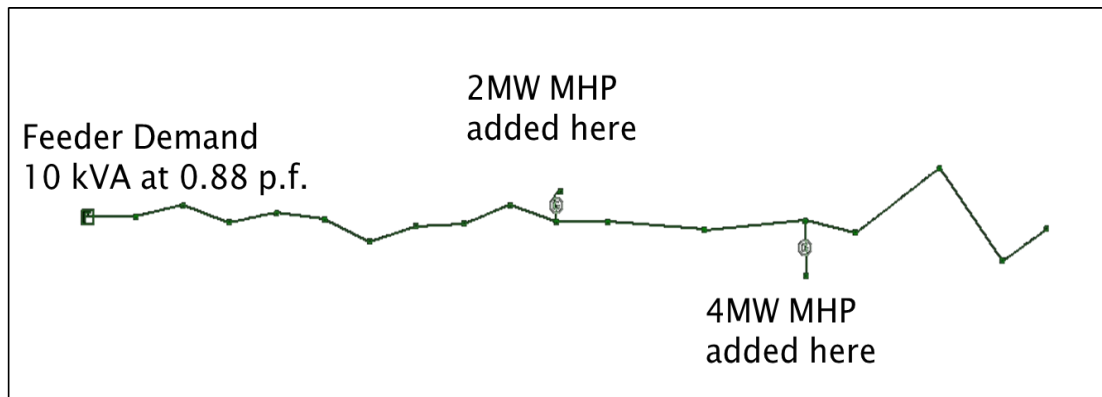

**Figure 3.7: Model Feeder with Two MHPs.**

Simulation were done according to the proposed method. After several iteration, final power factors of minimum loss configuration were obtained. Manual intervention between Genetic Algorithm calculation and then feeding the result of algorithm to SynerGee software for simulation is more difficult and is a time consume processes. Therefore, fully automated and fast study can be done with Matlab software in a flexible way.

### **3.2 Simulation with Matlab Software**

MATLAB (“MATrix LABoratory”) is a tool for numerical computation and visualization. It is widely used in all areas of applied mathematics, in the industry and in education and research at universities. Also widely used tool in worldwide for simulation. MATLAB stands for MATrix LABoratory and the software is built up around vectors and matrices. This makes the software particularly useful for linear algebra but MATLAB is also a great tool for solving algebraic and differential equations and for numerical integration. MATLAB has powerful graphic tools and capable of producing results by pictures in both 2D and 3D. It is also a programming language, and it is one of the easiest programming languages for writing mathematical programs. MATLAB also has some tool boxes useful for image processing, signal processing, optimization, etc. Simulink is an additional package, that’s capable of graphical multi-domain simulation and model-based design for dynamic and embedded systems. Simulink were used to model Electrical Distribution system and coding were done to simulate according to research objectives. After modelling and coding, fully



automated simulations were done with Matlab, whereas this is not possible with SynerGee software. Matlab Simulink R2014b version 8.4 was used for this simulation.

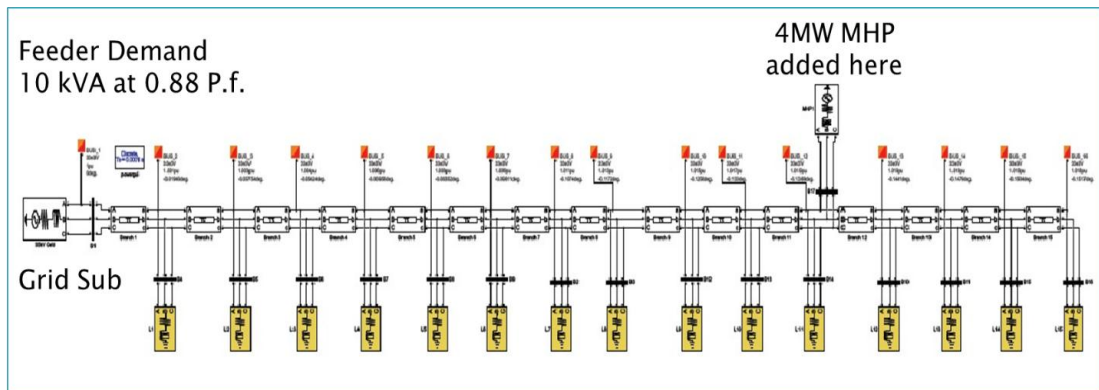

**Figure 3.8: Model Feeder with Single MHP in MATLAB Simulink**

Model feeder was implemented in Matlab with distributed loads totaling 10 kVA at power factor of 0.88 lagging with a length of 15 km. A 4MW MHP was added at 11km from grid substation. Line parameters were adjusted according to the line parameter tool by feeding row data of Racoon conductor. For parameters of the Grid substation and MHP, average practical values at CEB power system were used. Several load flow analyses were done with the help of load flow tool in “PowerGui” module. Results were obtained for peak and off peak demand situations and plotted as shown in figure 3.9. Obtained results were similar to the result from SyneerGEE simulation. Results show that the power factor of MHP at peak load is closer to 0.8 and, at off peak it is closer to 0.95. According to figure 3.9, power factor which gives minimum losses during peak demand is not giving the minimum losses when it’s operating at off peak demand. Further, if MHP operate at power factor which suitable for peak time, at off peak, will result in more losses than when it was operated at unity power factor.

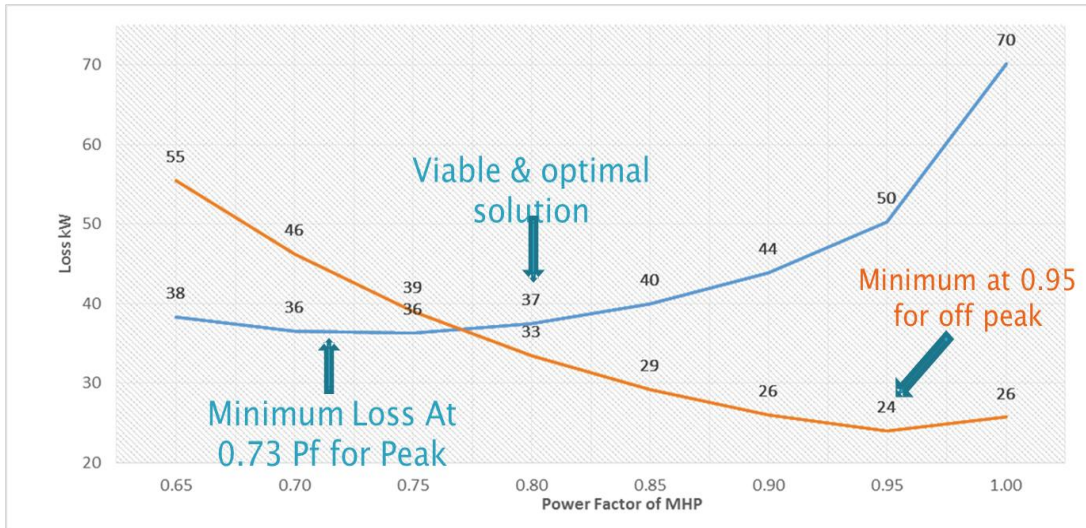

**Figure 3.9: Results of Model Feeder with Single MHP**

Further, to study the validity of this method, a model feeder with two MHPs were implemented as shown in figure 3.10. In the model, another 2MW was added to the same model feeder at 8km distance from the grid substation.

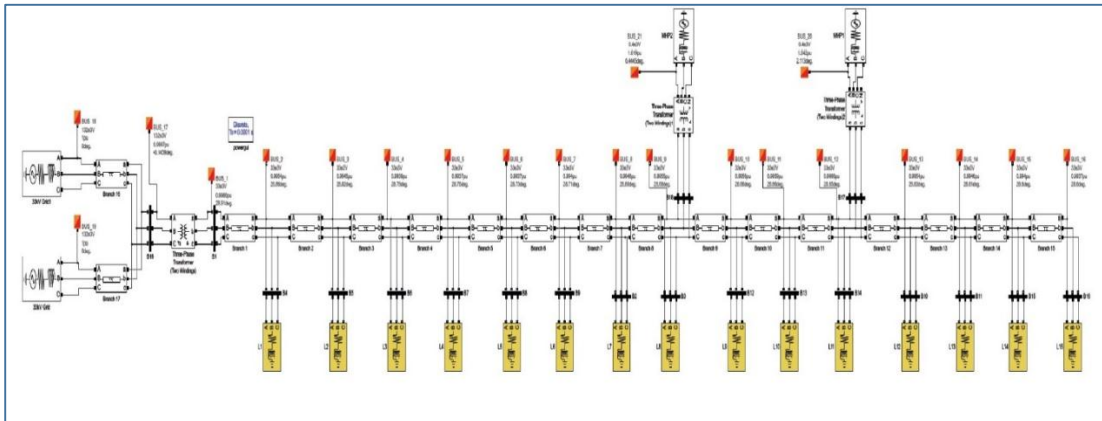

**Figure 3.10: Model Feeder with Two MHP in Matlab**

Simulations were done by varying power factor 0.8 to 1.0 in 0.01 intervals in both MHPs. 400 combination were simulated and results were obtained as shown in table 3.2. With the increment of MHPs in the MV power line and sensitivity of power factors, number of simulations are increasing and it is leading to confusion. Graphical representation (Figure 3.11) shows how the losses of the line change in above modeled power line in 3D view. In some regions, values are not changing considerably. But final

answer from the proposed method lies in to lowest region as highlighted in figure 3.2. Hence, those answers could be accepted as reasonable ground without doing more simulation. On the other hand loads are changing with time and it's stochastic. Therefore, finding operating point in the highlighted region is fair and justifiable.

**Table 3.2: System Loss with Variation of Power Factor in MHPs by 0.01 Intervals**

	1.00	0.99	0.98	0.97	0.96	0.95	0.94	0.93	0.92	0.91	0.90	0.89	0.88	0.87	0.86	0.85	0.84	0.83	0.82	0.81	0.80
1.00	81.35	74.01	71.13	68.97	67.17	65.60	64.19	62.91	61.72	60.60	59.55	58.55	57.60	56.69	55.81	54.97	54.16	53.37	52.61	51.87	51.15
0.99	64.98	58.97	56.64	54.91	53.48	52.24	51.13	50.13	49.21	48.35	47.54	46.79	46.07	45.39	44.74	44.12	43.53	42.96	42.41	41.89	41.38
0.98	59.22	53.74	51.64	50.08	48.80	47.70	46.71	45.83	45.01	44.26	43.56	42.90	42.28	41.69	41.13	40.60	40.10	39.62	39.16	38.73	38.31
0.97	55.16	50.10	48.17	46.75	45.58	44.58	43.69	42.90	42.17	41.49	40.87	40.29	39.74	39.23	38.74	38.28	37.85	37.44	37.05	36.68	36.33
0.96	51.98	47.27	45.49	44.18	43.12	42.20	41.40	40.67	40.02	39.41	38.86	38.34	37.85	37.40	36.97	36.57	36.20	35.85	35.52	35.20	34.91
0.95	49.36	44.97	43.32	42.11	41.13	40.30	39.56	38.91	38.32	37.77	37.27	36.81	36.38	35.99	35.61	35.27	34.94	34.64	34.36	34.10	33.87
0.94	47.15	43.04	41.51	40.40	39.50	38.73	38.07	37.47	36.94	36.45	36.00	35.60	35.22	34.87	34.55	34.25	33.97	33.72	33.49	33.28	33.08
0.93	45.24	41.40	39.98	38.96	38.13	37.43	36.82	36.29	35.81	35.37	34.98	34.62	34.29	33.99	33.71	33.46	33.23	33.02	32.83	32.66	32.51
0.92	43.58	39.99	38.68	37.73	36.98	36.34	35.79	35.31	34.88	34.50	34.15	33.83	33.55	33.29	33.06	32.85	32.66	32.49	32.34	32.22	32.11
0.91	42.13	38.78	37.56	36.70	36.01	35.43	34.94	34.51	34.12	33.79	33.48	33.21	32.97	32.75	32.56	32.39	32.24	32.12	32.01	31.92	31.85
0.90	40.85	37.73	36.61	35.82	35.19	34.67	34.23	33.85	33.52	33.22	32.96	32.74	32.53	32.36	32.21	32.08	31.97	31.88	31.81	31.76	31.72
0.89	39.73	36.83	35.80	35.08	34.52	34.06	33.67	33.33	33.04	32.79	32.57	32.39	32.22	32.09	31.97	31.88	31.81	31.75	31.72	31.71	31.71
0.88	38.74	36.06	35.12	34.47	33.97	33.56	33.22	32.93	32.69	32.48	32.30	32.15	32.03	31.93	31.85	31.80	31.76	31.74	31.75	31.77	31.81
0.87	37.88	35.41	34.56	33.98	33.54	33.18	32.89	32.64	32.44	32.28	32.14	32.03	31.94	31.88	31.84	31.82	31.82	31.83	31.87	31.93	32.00
0.86	37.14	34.88	34.12	33.60	33.21	32.90	32.66	32.46	32.30	32.17	32.08	32.00	31.95	31.93	31.92	31.94	31.97	32.02	32.09	32.18	32.29
0.85	36.51	34.45	33.77	33.32	32.99	32.73	32.53	32.38	32.26	32.17	32.11	32.08	32.06	32.07	32.10	32.15	32.22	32.30	32.41	32.53	32.67
0.84	35.98	34.12	33.52	33.14	32.86	32.66	32.50	32.39	32.31	32.26	32.24	32.24	32.26	32.31	32.37	32.45	32.55	32.67	32.81	32.97	33.14
0.83	35.55	33.89	33.37	33.05	32.83	32.67	32.56	32.49	32.46	32.45	32.46	32.50	32.56	32.63	32.73	32.85	32.98	33.13	33.30	33.49	33.70
0.82	35.22	33.75	33.32	33.06	32.89	32.78	32.72	32.69	32.69	32.72	32.77	32.84	32.94	33.05	33.18	33.33	33.49	33.68	33.88	34.10	34.34
0.81	34.98	33.70	33.35	33.15	33.04	32.98	32.96	32.97	33.02	33.08	33.17	33.28	33.40	33.55	33.71	33.89	34.09	34.31	34.54	34.80	35.07
0.80	34.84	33.75	33.48	33.34	33.28	33.27	33.29	33.35	33.43	33.53	33.66	33.80	33.96	34.14	34.34	34.55	34.78	35.03	35.29	35.58	35.88

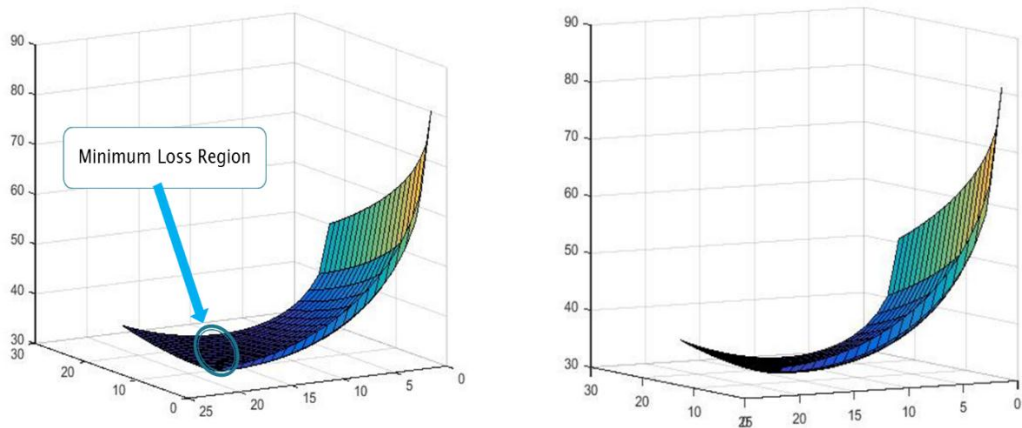

**Figure 3.11: Graphical Representation of 400 Nos Simulations**

Genetic Algorithm optimization techniques were applied to find minimum loss configuration of MHP's power factor by less number of simulation. Flow chart for simulation of power system with genetic algorithm in Matlab is shown figure 3.12. In

the Matlab model, simulation process will be done automatically, whereas in SynerGEE software, the simulation should be done step by step by calculating genetic algorithm manually. But to apply this method for a total power distribution system, modeling of power lines in Matlab has to be done from beginning as Matlab is not used for MV planning in CEB.

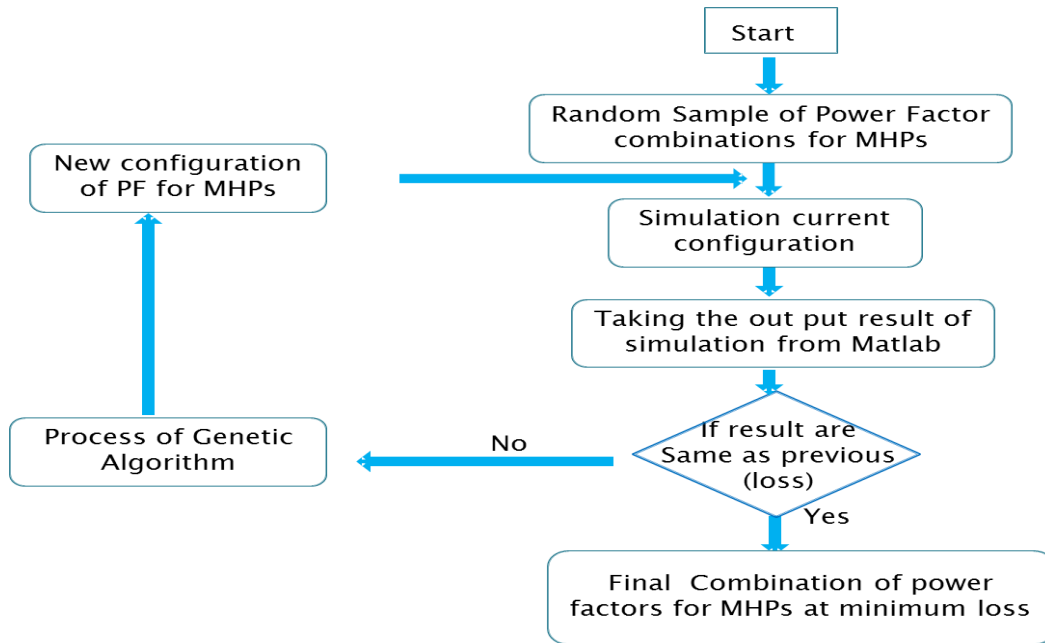

**Figure 3.12: Flow Chart of Simulation Method with Matlab**

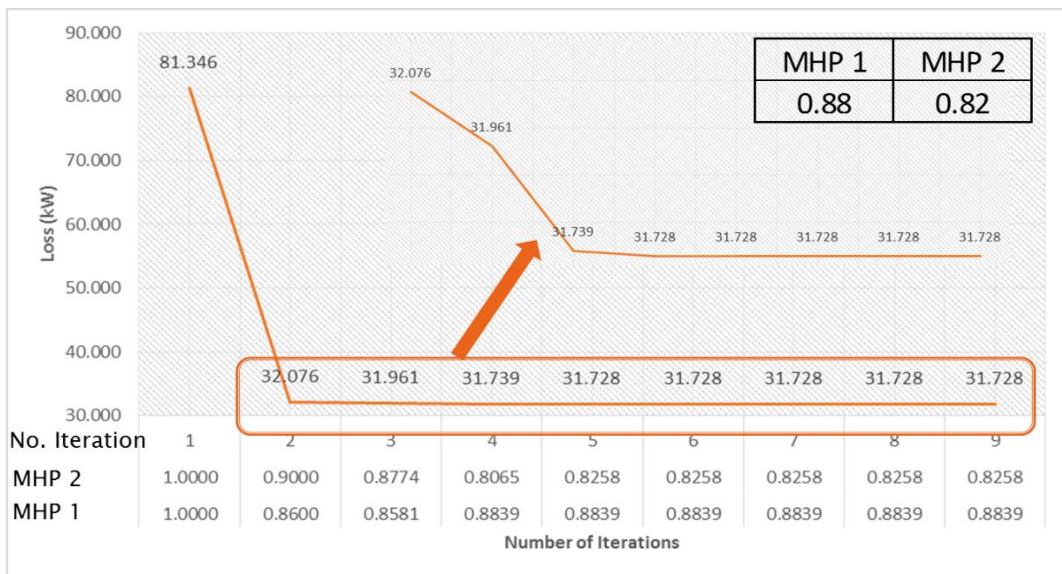

**Figure 3.13: Results of Model Feeder with Two MHPs with Genetic Algorithm for Peak Load**

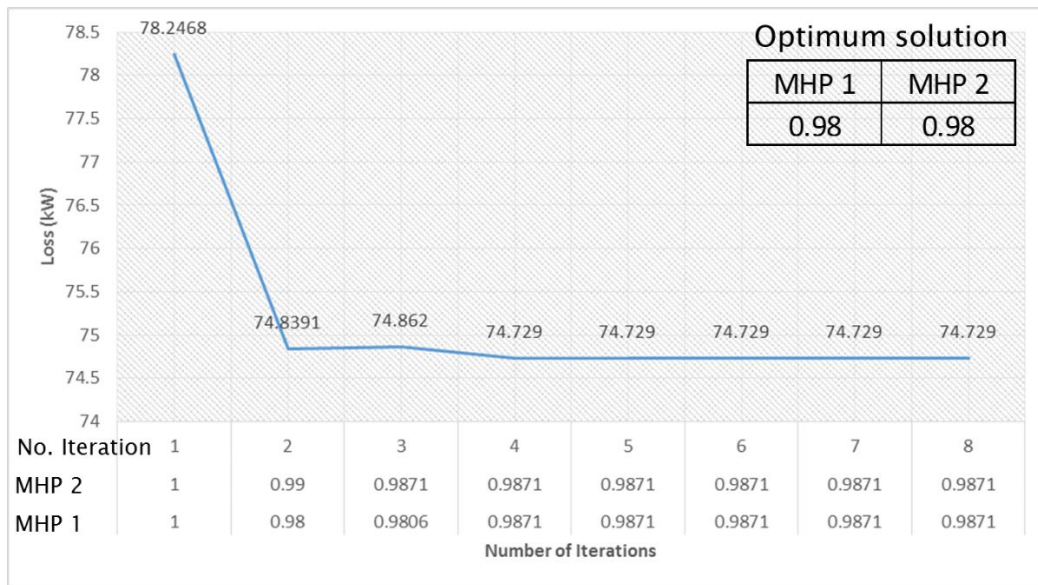

**Figure 3.14: Results of Model Feeder with Two MHPs with Genetic Algorithm for Off Peak Load**

Figure 3.13 shows that the optimum power factors to run at peak load for the model feeder is at 0.88 and 0.82 for MHP1 and MHP2 respectively. Therefore, this scenario could be extended for feeders with more MHPs with less number of iterations.

## CASE STUDY WITH UKUWELA FEEDER-10

### 4.1 Introduction

In chapter 3, modeling of distribution power system and analysis of loss reduction for model feeders were done by using SynerrGee and Matlab softwares. In this chapter, modeling and analysis of loss reduction is discussed for an actual feeder in Ukuwela grid substation for different load condition during a day. In modeling, scattered loads in power line was simplified by assuming that these loads are in the middle and end of the lines or spurs. If a capacitor bank is available at a grid substation, reactive power requirement of MV system could be supplied through the capacitors (Figure 4.1). Therefore, losses due to reactive power flow in HV lines will not change with proposed method. Hence the transmission lines can be neglected for simulation. Due to non-availability of capacitor bank at the Ukuwela grid substation, two transmissions (132kV) line were also model for the simulation.

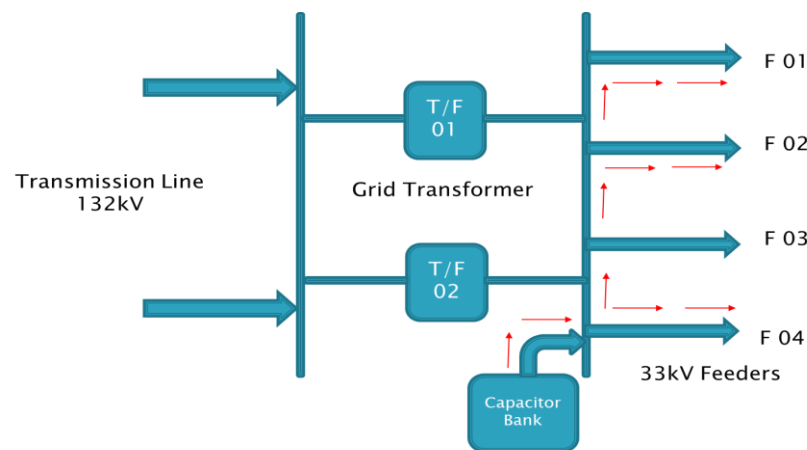

49

**Figure 4.1: Reactive Power Flow with 33kV Capacitor Bank at Grid Substation**

Existing MHPs at this feeder are Falcan, Werapitiaya and Giddawa. Power Factors of MHPs were varied to study variation of losses in the Feeder. MHPs run at 80% of its full capacity. Off peak and peak demand conditions were studied and 25% of peak demand was taken as off peak. Figure 4.3 and 4.4 shows the results of above simulation. In peak demand, Falcan, Werapitiaya and Giddawa should run at 0.81, 0.81 and 0.82 power factors respectively. At off peak it should be 0.89, 0.81 and 0.94.

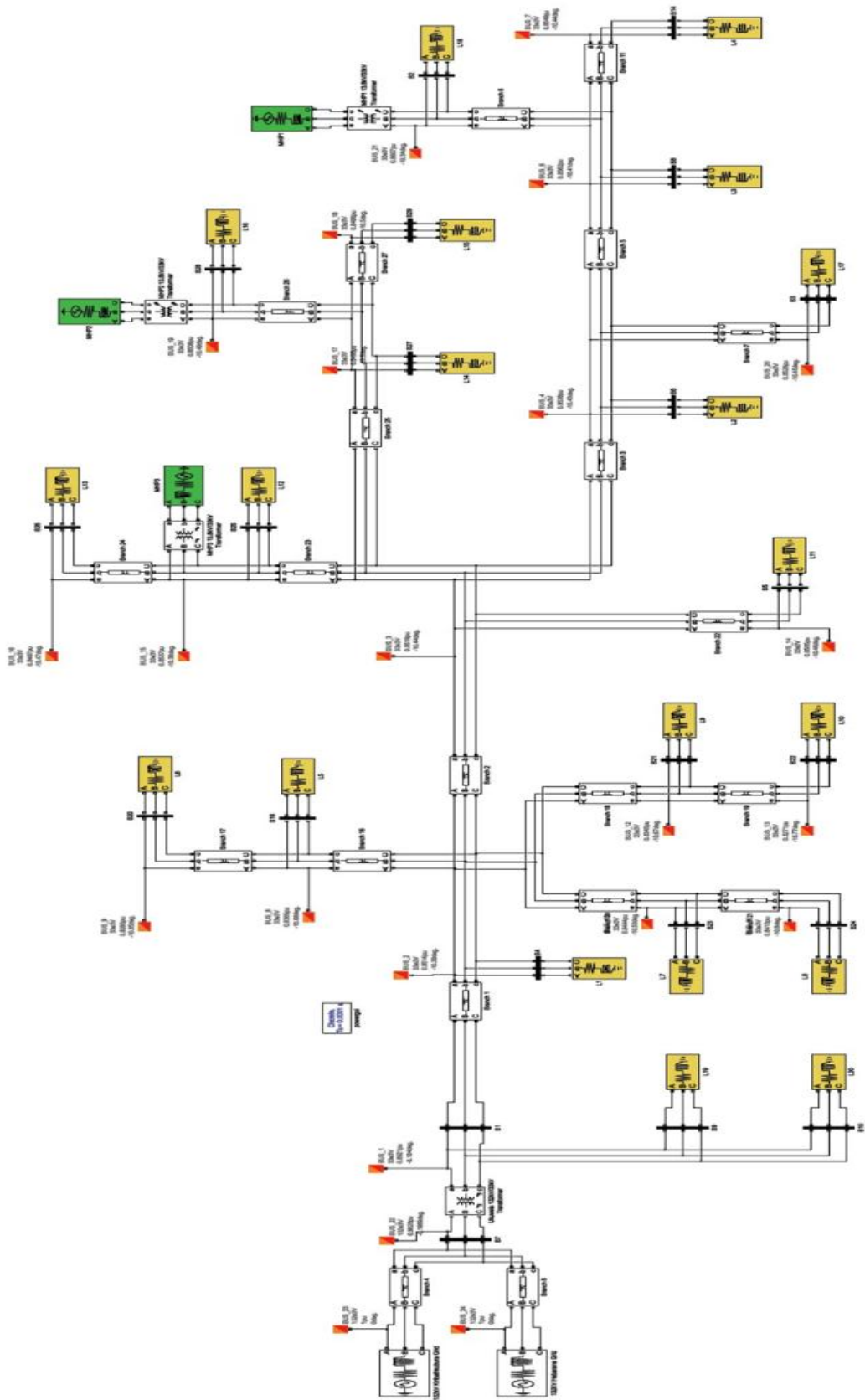
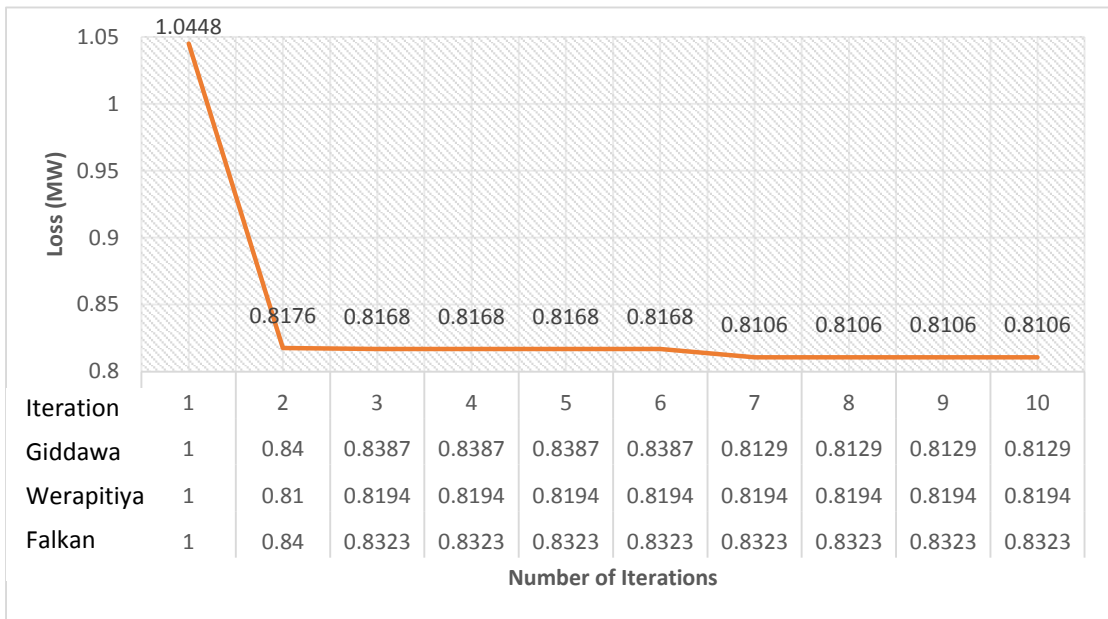
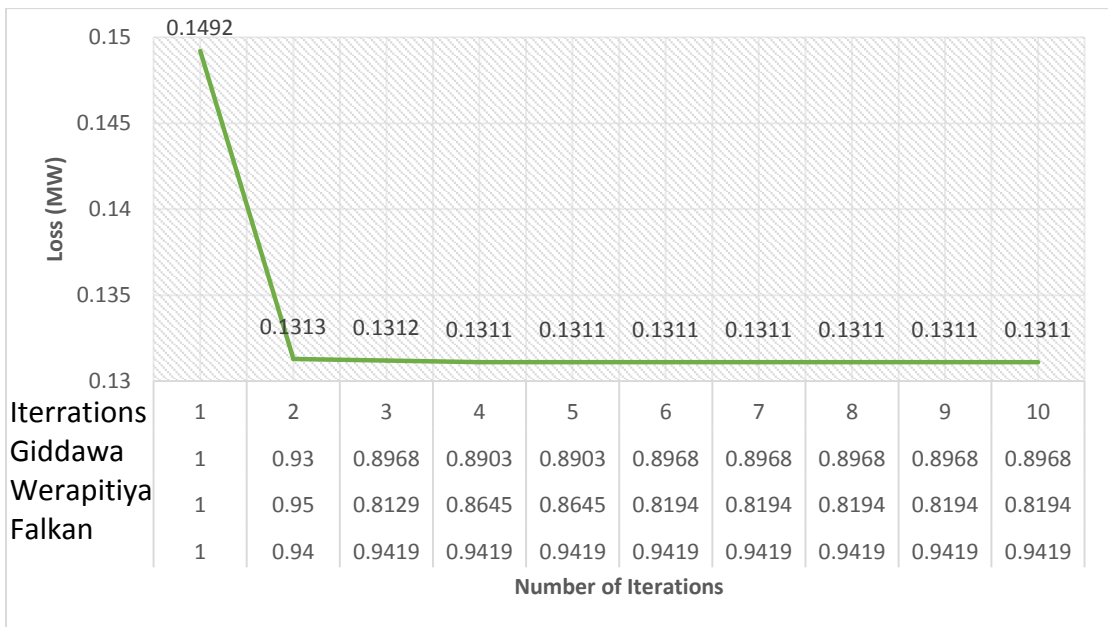

Figure 4.2: Ukuwela F10 and Two Transmission Line model in Matlab

Prepared Matlab coding and Simulink design gives optimal operating point from less than 10 iterations



**Figure 4.3: Peak Simulation Result for Minimum Losses**



**Figure 4.4: Off Peak Simulation Result for Minimum Losses**

## 4.2 Demand Curves for Ukuwela Feeder-10

Readings from grid substation and MHPs were considered for Feeder demand calculations. It was assumed that the load variation along the feeder at any point is as



same as the load variation at the point of grid substation throughout the day. Reactive power consumption profile is different from the active power consumption in a day at feeder 10. Active power peak occurred at 20.00hrs where reactive power peak occurred at 13.00hrs of the day.

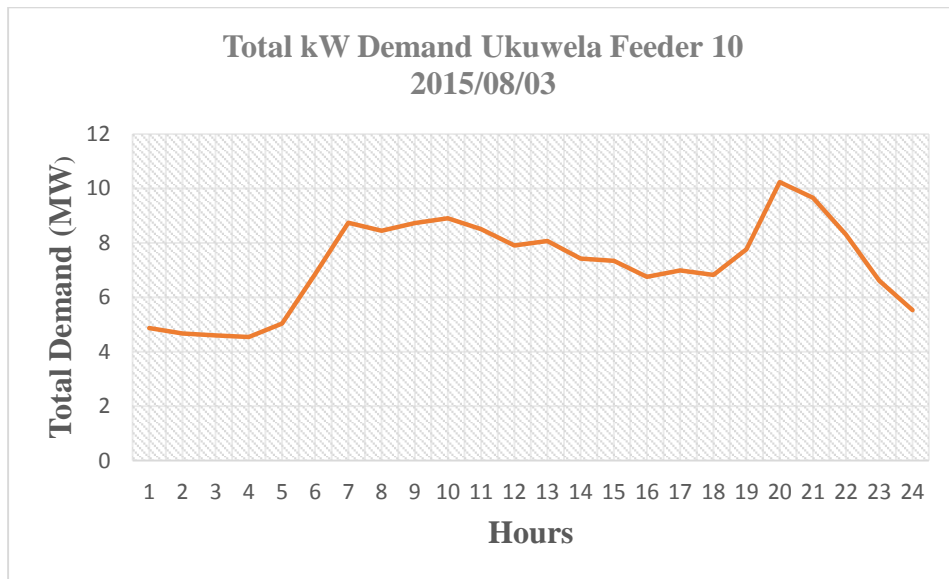

**Figure 4.5: Active Power Demand Curves for Ukuwela Feeder-10**

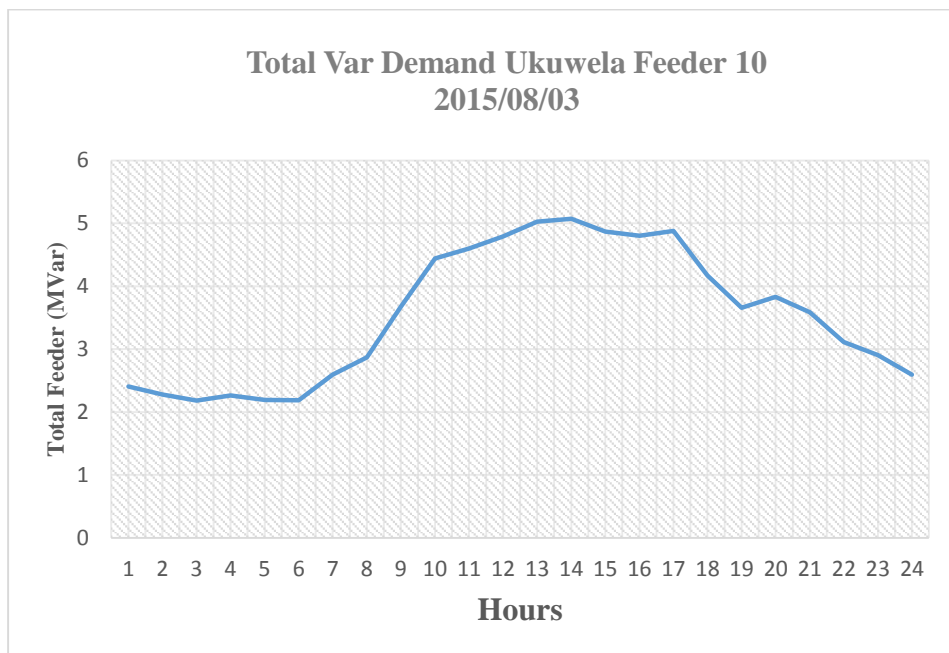

**Figure 4.6: Reactive Power Demand Curves for Ukuwela Feeder-10**

Hourly feeder demand was calculated by using available data and incorporated to model and simulated to get best operating point where feeder losses are a minimum. The load variation in the feeder model is same for similar type of days in the month such as weekdays, weekends, Poya days etc. Therefore, pre assumptions for demand variation can be made to implement this method. Amount of loss reduction by proposed method is high in day and peak time rather than in off peak as illustrate in figure 4.7. Therefore implementing this method in low demand dates such as weekend and poya days can be avoid.

**Table 4.1: Hourly Power Factor Schedule for MHPs in Ukuwela Feeder 10**

Hours	MHP1 P.F (Falcan)	MHP2 P.F (Werapitiya)	MHP3 P.F (Giddawa)	Loss At Normal System (kW)	Loss At Proposed system (kW)	Amount of Reduction (kW)	Loss Reduction Percentage wise %
1	0.94	0.81	0.86	155	125	30	19.4
2	0.94	0.83	0.81	143	116	27	18.9
3	0.94	0.81	0.89	135	110	25	18.5
4	0.89	0.8	0.91	135	109	26	19.3
5	0.95	0.83	0.87	152	126	26	17.1
6	0.89	0.81	0.89	261	230	31	11.9
7	0.87	0.85	0.8	465	408	57	12.3
8	0.86	0.8	8	465	396	69	14.8
9	0.81	0.81	0.8	566	456	110	19.4
10	0.82	0.82	0.81	704	544	160	22.7
11	0.8	0.83	0.8	670	503	167	24.9
12	0.83	0.85	0.8	615	452	163	26.5
13	0.82	0.8	0.83	684	500	184	26.9
14	0.8	0.83	0.8	617	433	184	29.8
15	0.8	0.8	0.81	572	404	168	29.4
16	0.81	0.83	0.8	502	346	156	31.1
17	0.81	0.81	0.81	530	368	162	30.6
18	0.8	0.8	0.8	424	305	119	28.1
19	0.8	0.85	0.82	457	360	97	21.2
20	0.8	0.92	0.81	823	683	140	17.0
21	0.81	0.82	0.8	689	569	120	17.4
22	0.81	0.8	0.8	459	383	76	16.6
23	0.87	0.85	0.8	288	234	54	18.8
24	0.89	0.9	0.87	195	158	37	19.0

In some hours amount of loss saving is 184kW. Percentage of loss reduction from the present losses is varied from 17% to 31%. Present loss and losses at proposed method are graphically presented in figure 4.7.

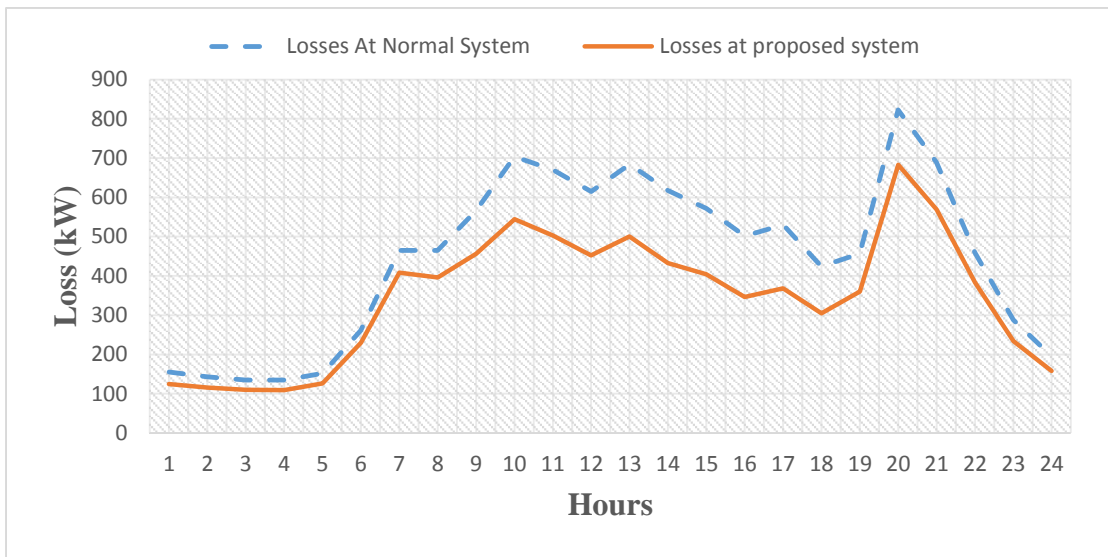

**Figure 4.7: Hourly Loss Variation in Current System and Propose System in Ukuwela Grid Feeder 10**

According to the figure 4.7, during day time loss saving of the power system is higher compared to the night time. However, there is a considerable loss reduction in this proposed method despite the time of the day.

---

### FINANCIAL ANALYSIS

The financial analysis looks in to the saving that can be achieved through reduction of losses in the feeder by using the proposed method. In this financial analysis it is considered that whole power system belongs to a single entity. No ownership separation between power system and MHPs exists and the financial benefit derived considering only the system point of view. Energy saving analysis done for the case study in chapter 4, is used for financial analysis.

#### 5.1 Cost of an energy unit for Ukuwela Feeder-10

Generation cost of an energy unit depends on the time it's produced. More expensive plants are used with the demand increase in the system. Therefore, generation cost of an energy unit varies with the load profile. In Sri Lankan contexts, consumers are charged base on time of used tariff except for retail consumers. In time of use basis a day is divided in to three time periods as day, peak and off peak. Table 5.1 gives the tariffs of average transfer price from Transmission to Distribution Licensees for Jan-June 2014 [15] publish by PUCSL and those values are taken for calculating financial saving.

**Table 5.1: Average Transfer Price from Transmission to Distribution Licensees  
Tariffs for Jan-June 2014**

Source: (Decision on Transmission and Bulk Supply tariffs, effect from January 2014 by PUCSL)

Tariff	Time Period	Cost(Rs.)
Day	05.30-17.30	11.49
Peak	17.30-21.30	14.48
Off Peak	00.00-05.30 21.30-00.00	8.54

## 5.2 Calculation of saving in a day at Ukuwela Feeder-10

Hourly power saving in a day was calculated and presented in the table 4.1. Amount of hourly energy saving were calculated and present in table 5.2.

**Table 5.2: Hourly Energy Saving in a Day at Ukuwela Feeder 10**

Hours	Amount of energy saving (kWh)	Unite Rate per Rs/kwh	Saving per Hour (Rs)
0.00 -1.00 (1)	30	8.54	256.20
1.00 -2.00 (2)	27	8.54	230.58
2.00 -3.00 (3)	25	8.54	213.50
3.00 -4.00 (4)	26	8.54	222.04
4.00 -5.00 (5)	26	8.54	222.04
5.00 -6.00 (6)	31	8.54	264.74
6.00 -7.00 (7)	57	11.49	654.93
7.00 -8.00 (8)	69	11.49	792.81
8.00 -9.00 (9)	110	11.49	1,263.90
9.00 -10.00 (10)	160	11.49	1,838.40
10.00 -11.00 (11)	167	11.49	1,918.83
11.00 -12.00 (12)	163	11.49	1,872.87
12.00 -13.00 (13)	184	11.49	2,114.16
13.00 -14.00 (14)	184	11.49	2,114.16
14.00 -15.00 (15)	168	11.49	1,930.32
15.00 -16.00 (16)	156	11.49	1,792.44
16.00 -17.00 (17)	162	11.49	1,861.38
17.00 -18.00 (18)	119	14.48	1,723.12
18.00 -19.00 (19)	97	14.48	1,404.56
19.00 -20.00 (20)	140	14.48	2,027.20
20.00 -21.00 (21)	120	14.48	1,737.60
21.00 -22.00 (22)	76	8.54	649.04
22.00 -23.00 (23)	54	8.54	461.16
23.00 -24.00 (24)	37	8.54	315.98
Total Energy saved /Day	2388	Rs. Saving/Day	27,881.96

## 5.3 Calculation of annual energy and financial saving in Ukuwela Feeder-10

Daily energy and financial saving from table 5.2 were taken for calculation of annual figures in table 5.3. Proposed method is more practical in weekdays since loads are high. In weekends and holidays amount of saving is less. Therefore for annual saving

calculation, only 24 days per month were considered neglecting savings from weekends and holidays.

**Table 5.3: Annual Energy Saving**

Total Energy saved(kWh)/Day	Days Per Month	Total Energy saved(kWh)/Month	Total Energy saved(kWh)/Year
2,388	24	57,312	687,744

**Table 5.4: Annual Financial Saving**

Total Rs. /Day	Days Per Month	Rs. Saving/Month	Rs. Saving/Year
27,881.96	24	669,167.04	8,030,004.48

Nearly, eight million rupees can be saved annually from Ukuwela F-10 by applying above proposed method. If segmentation is there, between the distribution power system operator and mini hydro power producers compensations should be paid for reactive power generations. This is because they are losing a small amount of active power due to reduction of efficiency of their generators by running at a low power factor.

### CONCLUSION

Electrical equipment consumes both active and reactive power, and the reactive power requirement is generated in the same way that active power is generated and has to be transmitted to the consumers. Both active and reactive power flows cause energy losses in power systems. Therefore, to minimize the losses in transmission, it is always advisable to compensate reactive power locally at the distribution end. This can be achieved by installing reactive power compensation devices such as Capacitor banks installed at distribution level or transmission level and use of distributed generators for reactive compensation at the medium voltage distribution network.

Most of the Generators at the MHPs are synchronous generators. Synchronous generators can run at both lagging and leading power factors according to the manufacture specification. According to the capability curve of generator reactive power generation can be done by over exciting field winding. Therefore, these MHPs can be used to supply reactive power requirement of the MV feeder system while achieving its primary objective of supplying active power to the system. This reactive power management results in active and reactive power loss saving in the MV system. On the other hand, additional reactive power generation also increases power losses in the MV system. Therefore, it is very important to select from which power plant to generate the reactive power, at which amount and what time. Hence optimization technique was used to solve above problem. Simulations were done with SyneerGee and Matlab software and optimization was done by using Genetic Algorithm. With syneerGee, simulation was done with manual calculation of genetic algorithm and feeding the results to the system. But, with Matlab fully automated simulation was done.

Finally, considerable amount of energy saving was proven. By using the proposed method, present loss in power system can be reduced by 20 -30 % at day and peak load and 5-10% at off peak. Case study was carried out on Ukuwela feeder 10. By applying

proposed method to Ukuwela feeder 10, around eight Million Sri Lankan Rupees could be saved yearly.

## **6.1 Recommendations**

- ❖ Distributed generator in the medium voltage network is a potential source to be consider for reactive power generation.
- ❖ Mini Hydro Plants are the ideal distributed generators to produce reactive power since they are not fully loaded all the time.
- ❖ Proper coordination is to be applied with the other reactive power compensators, MHPs and present demand using the proposed optimization tool.
- ❖ It is recommended to use proposed method without any uncertainty since it reduces present loss in MV system by 20 -30 %.
- ❖ Use of proposed method is highly recommended in day time. Since, more savings could be achieved in day time than off peak
  - Off peak loss reduction around 5-10 %
- ❖ With this method voltage profile along the feeder is increased. Therefore, more attention is to be paid on maximum voltage in off peak time.
- ❖ It is not recommended to use MHPs in dedicated feeders for generating reactive power over installing capacitors at Grid Substations by using the proposed method as it increases line length between load and reactive power generator.

## **6.2 Suggestions for future work**

Remote monitoring of data such as active and reactive power are possible in few places in mv network in CEB. Therefore, possibility of implementation of automated system for proposed method in a real time basis is to be studied with the implementation of Distribution Control Centers (DCC) with Supervisory Control and Data Aquatint (SCADA) systems, while streaming data from MHP's Meter points, Auto Recloses(AR) and from Grid substations.



## Reference List

- [1] “World energy outlook 2014 factsheet”, International Energy Agency, 2014
- [2] Prabha Kundur, “Power System Stability and Control” Chapter 5.
- [3] “Guide for Interconnection of embedded Generators”, CEB.
- [4] “Guideline to provincial Planning engineers in R3 for preparation of Grid interconnection of Embedded Generation”, CEB.
- [5] Dinakara Prasad Reddy P, C Hari Prasad, M C V Suresh, “Capacitor Placement Using Bat Algorithm for Maximum Annual Saving in Radial Distribution Systems”, Journal of engineering research and applications [www.ijera.com](http://www.ijera.com) ISSN:2248-9622, Vol 4, Issue 12(Part I),, December 2014, pp.105-109
- [6] Dr. Akram F. Bati, Dr. Nawfal M. Taher, BSC Omar H. Mohomad, “Optimal shunt capacitor placement in power distribution system using a genetic algorithm”, IJCCCE, VOL.4, NO.2, 2004
- [7] Luis F. Ochoa, Member, IEEE, and Gareth P. Harrison, member IEEE, “Minimising Energy Losses Optimal Accommodation and Smart Operation of Renewable Distributed Generation”
- [8] Julian Barquin, David Soler, Oscar Largo, Gregorio Relano and Ignacio de la Fuente, “On the Cost of the Reactive Power Generation and Voltage Support Service”, Bulk Power System Dynamics and Control IV-Restructuring, August 24-28, Santorini, Greece.
- [9] D. Faraji, A. Rabiei, B. Mohammadi, M. Hoseynpoor Meshkin Shahr Branch, Islamic Azad University, Meshkin Shahr, Iran, “Reactive Power Generation Management to Improve Voltage Stability Margin of Power Systems”, Australian Journal of Basic and Applied Sciences, 5(6): 957-963, 2011
- [10] S. Kongtripop<sup>1</sup>, T. Kasirawat<sup>1</sup>, C. Pongsriwat Provincial Electricity Authority (PEA), “Effect of Voltage Variation from Distributed Generation on Very Long Distribution Line with Multiple Voltage Regulators”

- [11] Constantin, Aurclin, Valentin, Ioan Dragons, Aurel Ionut, Ion Daniel. “Optimal reactive power compensation using synchronous generators”, International conference on renewable energies and power quality – Spain- 2010.
- [12] S. Kumara Injeti and Dr. Navuri P Kumara, “Optimal planning of Distributed Generation for improved Voltage stability and loss reduction”, International journal computer Applications Volume 15- No1 February 2011
- [13] Dinakara Prasad Reddy P, “Application of Loss Sensitivity Factor and Genetic Algorithm for Capacitor Placement for Minimum Loss in radial Distribution System”, International journal of engineering sciences & research technology, September 2013
- [14] Mr. Siddharth Deshmukh, Mr. Balasubramaniam Natarajan and Mr. Anil Pahwa, “Voltage/VAR Control in Distribution Networks via Reactive Power Injection Through Distributed generators”, IEEE Transaction on smart grid. Vol3. No3. September 2012
- [15] <http://www.pucsl.gov.lk/english/wp-content/uploads/2014/08/Decision-on-BST-2014H1.pdf>
- [16] K-10-0016203\_Technical Document\_En.doc Synchronous alternator project Owala MHP in Matale district.